



aerospace
 climate control
 electromechanical
 filtration
 fluid & gas handling
 hydraulics
 pneumatics
 process control
 sealing & shielding



Quick Coupling Products

Quick Couplings, Swivels, Valves,
 Diagnostic Equipment
 Catalog 3800 USA | February 2014



ENGINEERING YOUR SUCCESS.

Quick Coupling Division Locations



Minneapolis, MN



Grantsburg, WI



Chetek, WI



Union City, PA

WARNING

FAILURE OR IMPROPER SELECTION OR IMPROPER USE OF THE PRODUCTS DESCRIBED HEREIN OR RELATED ITEMS CAN CAUSE DEATH, PERSONAL INJURY AND PROPERTY DAMAGE.

- This document and other information from Parker-Hannifin Corporation, its subsidiaries and authorized distributors provide product or system options for further investigation by users having technical expertise.
- The user, through its own analysis and testing, is solely responsible for making the final selection of the system and components and assuring that all performance, endurance, maintenance, safety and warning requirements of the application are met. The user must analyze all aspects of the application, follow applicable industry standards, and follow the information concerning the product in the current product catalog and in any other materials provided from Parker or its subsidiaries or authorized distributors.
- To the extent that Parker or its subsidiaries or authorized distributors provide component or system options based upon data or specifications provided by the user, the user is responsible for determining that such data and specifications are suitable and sufficient for all applications and reasonably foreseeable uses of the components or systems.

Offer of Sale

The items described in this document are hereby offered for sale by Parker Hannifin Corporation, its subsidiaries or its authorized distributors. This offer and its acceptance are governed by the provisions stated in the "Offer of Sale."

Table of Contents

Pneumatic Quick Couplings.....Section A

Hydraulic Quick Couplings.....Section B

Thermoplastic Couplings.....Section C

Swivels.....Section D

Valves.....Section E

Diagnostic Products.....Section F

Appendices:

Fluid Compatibility Chart.....I

Safety Guide.....VI

Offer of Sale.....IX

Glossary of Terms.....X



Appendices

Fluid Compatibility Chart	I
Safety Guide	VII
Offer of Sale	IX
Glossary of Terms	X



Codes

The following seal compound and body material compatibility chart is provided as an aid in selecting a specific synthetic rubber compound or body material for a particular application. Operating and environmental conditions must be considered when making the selection of a quick coupling.

Refer to the appropriate section of the catalog for Ordering Information for Seal Codes for specific products.

To indicate a special material just add the appropriate code letter as a suffix to the catalog number of the coupler.

It is not necessary to use the code "STD" as the standard Nitrile seal will be used when another code is not used.

For recommendations for media not listed below, please contact your Parker representative or the factory.

Note

This chart is intended as a guide only and is not be considered as a recommendation to use Parker quick action couplings in a specific application or with a specific fluid, other factors that must be considered include but are not limited to: fluid and ambient temperature, system pressure, both operating and peak, frequency of connect and disconnect, and applicable standards or regulations.

CODES: 1 = Satisfactory 2 = Fair 3 = Not Recommended 4 = Insufficient Data Available

MEDIA	BODY MATERIAL				SEAL MATERIAL			
	Brass	Steel	316 S.S.	303 S.S.	Nitrile	E.P.	Fluorocarbon	Neoprene
3M FC-75	4	4	4	4	1	1	2	1
ACETAMIDE	4	4	1	2	1	1	3	1
ACETIC ACID (5%)	3	3	1	1	2	1	1	1
ACETONE	1	2	1	1	3	1	3	3
ACETOPHENONE	2	2	2	1	3	1	3	3
ACETYL ACETONE	2	2	2	2	3	1	3	3
ACETYL CHLORIDE	4	2	2	2	3	3	1	3
ACETYLENE	3	2	1	1	1	1	1	2
AIR (200 DEGREES F.)	1	2	1	1	1	1	1	1
AIR (300 DEGREES F.)	1	2	1	1	2	2	1	2
AIR (400 DEGREES F.)	1	2	1	1	3	3	1	3
ALUMINUM ACETATE	4	4	4	4	2	1	3	2
ALUMINUM BROMIDE	4	4	4	4	1	1	1	1
ALUMINUM CHLORIDE (10%)	3	3	3	3	1	1	1	1
ALUMINUM CHLORIDE (100%)	3	2	2	2	1	1	1	1
ALUMINUM FLOURIDE	3	3	3	3	1	1	1	1
ALUMINUM NITRATE	3	3	2	2	1	1	1	1
ALUMINUM SALTS	4	4	4	4	1	1	1	1
ALUMINUM SULPHATE	2	3	2	3	1	1	1	1
ALUMS (NH3,Cr,K)	4	4	4	4	1	1	3	1
AMMONIA (ANHYDROUS)	3	2	1	1	2	1	3	1
AMMONIA (COLD, GAS)	3	2	4	1	1	1	3	1
AMMONIA (HOT, GAS)	3	2	4	1	3	2	3	2
AMMONIUM CARBONATE	3	2	3	3	3	1	1	1
AMMONIUM CHLORIDE	3	3	2	3	1	1	1	1
AMMONIUM HYDROXIDE	3	3	1	2	3	1	3	1
AMMONIUM NITRATE	3	3	1	1	1	1	4	1
AMMONIUM PERSULFATE SOLUTION	3	3	1	2	3	1	4	4
AMMONIUM PHOSPHATE (MONO-, DI-, TRI-BASIC)	3	3	3	2	1	1	4	1
AMMONIUM SALTS	4	4	4	4	1	1	3	1
AMMONIUM SULFATE	3	3	2	3	1	1	3	1
AMYL BORATE	4	4	4	4	1	3	1	1
AMYL CHLORIDE	4	2	1	1	4	3	1	3
AMYL CHLORONAPHTHALENE	4	4	4	4	3	3	1	3
AMYL NAPHTHALENE	4	4	4	4	3	3	1	3
ANIMAL OIL (LARD OIL)	2	2	2	2	1	2	1	2
AROCLOR 1248	2	3	3	3	3	2	1	3
AROCLOR 1254	2	3	3	3	3	2	1	3
AROCLOR 1260	2	3	3	3	1	4	1	1
AROMATIC FUEL (50%)	4	4	4	4	2	3	1	3
ARSENIC ACID	3	3	1	1	1	1	1	1
ASPHALT	3	3	1	1	2	3	1	2
ASTM OIL, NO. 1	1	1	1	1	1	3	1	1
ASTM OIL, NO. 2	1	1	1	1	1	3	1	2



CODES: 1 = Satisfactory 2 = Fair 3 = Not Recommended 4 = Insufficient Data Available

MEDIA	BODY MATERIAL				SEAL MATERIAL			
	Brass	Steel	316 S.S.	303 S.S.	Nitrile	E.P.	Fluorocarbon	Neoprene
ASTM OIL, NO. 3	1	1	1	1	1	3	1	3
ASTM OIL, NO. 4	1	1	1	1	2	3	1	3
ASTM REFERENCE FUEL A	3	2	1	1	1	3	1	2
ASTM REFERENCE FUEL B	3	2	1	1	1	3	1	3
ASTM REFERENCE FUEL C	3	2	1	1	2	3	1	3
AUTOMOTIVE BRAKE FLUID	4	4	4	4	3	1	3	2
BARIUM CHLORIDE	3	3	2	3	1	1	1	1
BARIUM HYDROXIDE	3	2	2	3	1	1	1	1
BARIUM SALTS	4	4	4	4	1	1	1	1
BARIUM SULFIDE	3	2	3	3	1	1	1	1
BEER	3	3	1	1	1	1	1	1
BEET SUGAR LIQUORS	3	3	1	1	1	1	1	2
BENZALDEHYDE	3	3	2	3	3	1	3	3
BENZENE	3	2	3	3	3	3	1	3
BENZENESULFONIC ACID (10%)	3	3	3	3	3	3	1	2
BENZINE	4	4	4	4	1	3	1	2
BENZOIC ACID	3	3	3	3	3	3	1	3
BENZYL ALCOHOL	4	3	1	2	3	2	1	2
BENZYL CHLORIDE	3	3	2	3	3	3	1	3
BLEACH LIQUOR	4	4	4	4	3	1	1	2
BORAX	3	2	3	3	2	1	1	3
BORDEAUX MIXTURE	4	4	4	4	2	1	1	2
BORIC ACID	3	3	2	3	1	1	1	1
BRAKE FLUID (NON-PETROLEUM)	4	4	4	4	3	1	3	2
BRINE (SODIUM CHLORIDE)	3	3	1	1	1	1	1	1
BROMINE	4	4	4	4	3	3	1	3
BROMINE WATER	4	4	4	4	3	2	1	3
BUNKER OIL	4	4	4	4	1	3	1	3
BUTADIENE (MONOMER)	3	2	1	2	3	3	1	3
BUTANE	3	1	1	1	1	3	1	1
BUTANE (2,2, & 2,3-DIMETHYL)	4	4	4	4	1	3	1	2
BUTANOL (BUTYL ALCOHOL)	2	1	1	1	1	2	1	1
BUTTER - ANIMAL FAT	2	3	1	2	1	1	1	2
BUTYL BUTYRATE	4	4	4	4	3	1	1	3
BUTYL STEARATE	4	4	4	4	2	3	1	3
CALCINE LIQUORS	4	4	4	4	1	1	1	4
CALCIUM ACETATE	4	4	4	4	2	1	3	2
CALCIUM BISULFITE	3	3	2	3	2	1	2	2
CALCIUM CARBONATE	3	2	3	2	1	1	1	1
CALCIUM CHLORIDE	3	3	2	3	1	1	1	1
CALCIUM HYDROXIDE	3	3	2	3	1	1	1	1
CALCIUM HYPOCHLORITE	3	3	2	3	2	1	1	2
CALCIUM SALTS	4	4	4	4	1	1	1	1
CALCIUM SULFIDE	3	3	2	2	1	1	1	1
CALICHE LIQUORS	4	4	4	4	1	1	1	1
CANE SUGAR LIQUORS	4	2	1	1	1	1	1	1
CARBON BISULPHIDE	4	4	4	4	3	3	1	3
CARBON DIOXIDE	1	2	1	1	1	1	1	1
CARBON DISULFIDE	2	2	2	2	3	3	1	3
CARBON MONOXIDE	1	1	1	1	1	1	1	2
CARBON TETRACHLORIDE	2	3	1	3	2	3	1	3
CARBONIC ACID	3	3	1	2	2	1	1	1
CASTOR OIL	1	1	1	1	1	2	1	1
CELLUGUARD	4	4	4	4	1	1	1	1
CELLULUBE (NOW FYRQUEL)	4	4	4	4	3	1	1	3
CHINA WOOD OIL (TUNG OIL)	2	2	1	1	1	3	1	2
CHLORINATED SALT BRINE	4	4	4	4	3	3	1	3
CHLORINATED SOLVENTS	4	4	4	4	3	3	1	3
CHLOROBENZENE	3	3	2	3	3	3	1	3
CHLOROBUTADIENE	4	4	4	4	3	3	1	3
CHLOROFORM	3	2	2	1	3	3	1	3
CHLORPHENOL	4	4	4	4	3	3	1	3
COCONUT OIL	4	4	4	4	1	3	1	3
COPPER CHLORIDE	4	4	4	4	1	1	1	2
COPPER SALTS	4	4	4	4	1	1	1	1
COPPER SULFATE	3	3	2	3	1	1	1	1

CODES: 1 = Satisfactory 2 = Fair 3 = Not Recommended 4 = Insufficient Data Available

MEDIA	BODY MATERIAL				SEAL MATERIAL			
	Brass	Steel	316 S.S.	303 S.S.	Nitrile	E.P.	Fluorocarbon	Neoprene
CORN OIL	2	1	1	1	1	3	1	3
COTTONSEED OIL	3	2	1	2	1	3	1	3
CREOSOLS	3	2	1	2	3	3	1	3
CREOSOTE	3	3	2	1	1	3	1	2
CRESYLIC ACID	4	2	1	2	3	3	1	3
CRUDE OIL	3	2	1	1	2	3	1	3
CUTTING OIL	4	1	1	1	1	3	1	2
DECANE	4	4	4	4	1	3	1	3
DENATURED ALCOHOL	4	4	4	4	1	1	1	1
DETERGENT, WATER SOLUTION	3	3	1	1	1	1	1	2
DIESEL FUEL	1	1	1	1	1	3	1	3
DIETHYLENE GLYCOL	3	1	1	1	1	1	1	1
DIMETHYL FORMAMIDE	4	4	1	1	2	1	3	3
DOW CHEMICAL HD50-4	4	4	4	4	4	1	3	2
DOW CORNING 200, 510, 550	4	4	4	4	2	1	1	1
DOWTHERM A,E	3	1	2	2	3	3	1	3
ETHANOL	1	3	3	3	3	1	3	1
ETHYL CHLORIDE	2	3	1	3	1	3	1	3
ETHYL HEXANOL	4	4	4	4	1	1	1	1
ETHYLENE DICHLORIDE	3	3	1	2	3	3	1	3
ETHYLENE GLYCOL	2	2	1	2	1	1	1	1
FATTY ACIDS	3	3	1	2	2	3	1	2
FREON 11	1	4	4	4	2	3	2	3
FREON 12	1	1	3	1	2	3	1	1
FREON 22	1	3	1	1	3	3	3	1
FREON 134a	1	1	1	1	2	1	4	1
FUEL OIL	3	1	1	1	1	3	1	2
GALLIC ACID	3	3	2	2	2	2	1	2
GAS, LIQUID, PROPANE (LPG)	1	3	1	1	1	3	1	2
GAS, NATURAL	2	3	1	1	1	3	1	1
GASOLINE	1	2	1	1	3	3	1	3
GELATIN	3	3	1	1	1	1	1	1
GLUCOSE	1	1	1	1	1	1	1	1
GLYCERINE (GLYCEROL)	2	1	1	1	1	1	1	1
GLYCOLS	3	2	2	2	1	1	3	1
GREEN SULFATE LIQUOR	3	3	3	3	2	1	1	2
GULF - FR FLUID (EMULSION)	4	4	4	4	1	3	1	2
GULF - FR FLUID G	4	4	4	4	1	1	1	1
GULF - FR FLUID P	4	4	4	4	3	2	2	3
HELIUM	1	1	1	1	1	1	1	1
HEPTANE	1	1	1	1	1	3	1	2
HYDRAULIC OIL (PETROLEUM BASE)	1	1	1	1	1	3	1	1
HYDRAULIC OIL (WATER BASE)	4	1	1	1	2	1	3	2
HYDRAZINE	4	3	1	1	2	1	3	2
HYDROGEN GAS	2	2	1	1	1	1	1	1
HYDROLUBE	4	4	4	4	1	1	1	2
ISO OCTANE	1	1	1	1	1	3	1	2
ISOBUTYL ALCOHOL	4	4	1	1	2	1	1	1
ISOPROPYL ALCOHOL	1	1	2	1	2	1	1	2
ISOPROPYL ETHER	1	1	1	1	2	3	3	3
JP3 AND JP4	1	1	1	1	1	3	1	3
KEROSENE	1	1	1	1	1	3	1	2
LARD, ANIMAL FAT	1	1	1	1	1	2	1	2
LINSEED OIL	3	1	1	1	1	3	1	3
LUBRICATING OIL SAE 10, 20, 30, 40, 50	1	1	1	1	1	3	1	2
MAGNESIUM SALTS	4	4	4	4	1	1	1	1
MAGNESIUM SULPHATE	3	3	2	2	1	1	1	1
MERCURY	3	3	1	1	1	1	1	1
METHANE	1	3	1	1	1	3	1	2
METHANOL	1	1	1	1	1	1	3	1
METHYL BROMIDE	4	1	1	1	2	3	1	3
METHYL CHLORIDE (DRY)	2	3	1	1	3	3	1	3
METHYL CHLORIDE (WET)	1	3	1	3	3	3	1	3
METHYL ETHER	4	4	4	4	1	3	1	3
METHYL ETHYL KETONE (MEK)	1	1	1	1	3	1	3	3
MIL-F-81912 (JP-9)	1	1	1	1	3	3	1	3

CODES: 1 = Satisfactory 2 = Fair 3 = Not Recommended 4 = Insufficient Data Available

MEDIA	BODY MATERIAL				SEAL MATERIAL			
	Brass	Steel	316 S.S.	303 S.S.	Nitrile	E.P.	Fluorocarbon	Neoprene
MIL-H-5606	1	1	1	1	1	3	1	2
MIL-H-6083	1	1	1	1	1	3	1	1
MIL-H-7083	1	1	1	1	1	1	2	2
MIL-H-8446 (MLO-8515)	2	1	1	1	2	3	1	1
MIL-L-2104 & 2104B	1	1	1	1	1	3	1	2
MIL-L-7808	3	2	1	1	2	3	1	3
MILK	2	1	1	1	1	1	1	1
MINERAL OILS	1	1	1	1	1	3	1	2
MLO-7277 AND MLO-7557	2	1	1	1	3	3	1	3
MOBILE HF	1	1	1	1	1	3	1	2
MONOMETHYL HYDRAZINE	4	4	4	4	2	1	4	2
NAPHTHA (COAL OR PETROLEUM)	2	1	2	2	2	3	1	3
NAPHTHALENE	2	1	2	2	3	3	1	3
NAPHTHENIC ACID	2	1	2	2	2	3	1	3
NEATSFOOT OIL	4	4	4	4	1	2	1	3
NICKEL, ACETATE	3	2	1	1	2	1	3	2
NICKEL CHLORIDE	3	3	2	2	1	1	1	2
NICKEL SALTS	4	4	4	4	1	1	1	2
NICKEL SULFATE	3	3	1	1	1	1	1	1
NITROGEN	1	1	1	1	1	1	1	1
NITROUS OXIDE	2	2	2	1	1	4	4	4
OCTYL ALCOHOL	1	1	1	1	2	3	1	2
OLIVE OIL	2	1	1	1	1	2	1	2
ORTHO-DICHLOROBENZENE	2	2	2	2	3	3	1	3
OXALIC ACID	3	3	2	1	2	1	1	2
OXYGEN (200-400 DEGREES F.)	1	1	1	1	3	3	2	3
OXYGEN, COLD	1	1	1	1	2	1	1	1
OZONE	3	3	1	1	3	1	1	3
PALMITIC ACID	1	2	1	1	1	2	1	2
PARA-DICHLOROBENZENE	2	1	1	2	3	3	1	3
PARKER O LUBE	1	1	1	1	1	3	1	1
PEANUT OIL	2	1	1	1	1	3	1	3
PENTANE (2-3-METHYL, & 2-4 DIMETHYL)	2	2	2	2	1	3	1	2
PERCHLORIC ACID -2N	3	3	2	2	3	2	1	2
PERCHLOROETHYLENE	3	2	2	2	2	3	1	3
PETROLATUM	1	1	1	1	1	3	1	2
PETROLEUM OIL, BELOW 250 DEGREES F.	1	1	1	1	1	3	1	2
PHENOL	1	1	1	1	3	3	1	3
PHOSPHORIC ACID (3 MOLAR)	3	3	2	2	1	1	1	2
PHOSPHORIC ACID (CONCENTRATED)	3	3	2	2	3	1	1	3
PHOSPHOROUS TRICHLORIDE	3	3	1	1	3	1	1	3
PICRIC ACID, MOLTEN	3	3	2	2	2	2	1	2
PICRIC ACID, WATER SOLUTION	3	3	2	2	1	1	1	1
PINE OIL	2	2	1	2	1	3	1	3
PLATING SOLUTIONS (CHROME)	1	3	1	1	4	1	1	3
PLATING SOLUTIONS (OTHER)	4	1	1	1	1	1	1	3
PNEUMATIC SERVICE	1	1	1	1	1	1	1	1
POTASSIUM ACETATE	2	1	2	2	2	1	3	2
POTASSIUM CHLORIDE	3	3	1	2	1	1	1	1
POTASSIUM CYANIDE	3	2	2	2	1	1	1	1
POTASSIUM DICHROMATE	3	1	2	2	1	1	1	1
POTASSIUM HYDROXIDE (50%)	3	2	1	2	2	1	3	2
POTASSIUM NITRATE	2	1	1	1	1	1	1	1
POTASSIUM SALTS	4	4	4	4	1	1	1	1
POTASSIUM SULFATE	3	2	1	1	1	1	1	1
PRL-HIGH TEMP. HYDR. OIL	4	4	4	4	2	3	1	2
PRODUCER GAS	2	1	1	1	1	3	1	2
PROPANE	1	3	1	1	1	3	1	2
PROPYL ACETATE	3	1	1	1	3	2	3	3
PROPYL ALCOHOL	1	1	1	1	1	1	1	1
PROPYLENE	1	1	1	1	3	3	1	3
PYDRAUL 10E	3	1	1	1	3	1	3	3
PYDRAUL A-200, C SERIES	3	1	1	1	3	3	1	3
PYDRAUL, 3 SERIES	3	1	1	1	3	1	1	3
PYROGARD 42, 43, 53, 55 (PHOSPHATE ESTER)	4	4	4	4	3	1	1	3

Appendices



CODES: 1 = Satisfactory 2 = Fair 3 = Not Recommended 4 = Insufficient Data Available

MEDIA	BODY MATERIAL				SEAL MATERIAL			
	Brass	Steel	316 S.S.	303 S.S.	Nitrile	E.P.	Fluorocarbon	Neoprene
PYROGARD D	4	4	4	4	1	3	3	2
SEA WATER (SALT WATER)	2	3	1	1	1	1	1	2
SHELL IRUS 905	4	4	4	4	1	3	1	2
SILICONE GREASES	1	1	1	1	1	1	1	1
SILVER NITRATE	3	3	1	2	2	1	1	1
SKYDROL 500, TYPE 2	3	1	1	1	3	1	3	3
SKYDROL 7000, TYPE 2	3	1	1	1	3	1	2	3
SOAP SOLUTIONS	3	3	1	1	1	1	1	2
SODIUM ACETATE	1	1	1	1	2	1	3	2
SODIUM BICARBONATE (BAKING SODA)	2	2	1	1	1	1	1	1
SODIUM BISULPHATE OR BISULPHITE	3	3	2	1	1	1	1	1
SODIUM BORATE	3	2	2	2	1	1	1	1
SODIUM CARBONATE (SODA ASH)	4	1	1	1	1	1	1	1
SODIUM CHLORIDE	3	2	2	2	1	1	1	1
SODIUM CYANIDE	3	1	1	1	1	1	4	1
SODIUM HYDROXIDE (CAUSTIC SODA, LYE)	3	2	1	2	2	1	2	2
SODIUM HYDROXIDE, 50%	3	3	1	2	2	1	2	2
SODIUM METAPHOSPHATE	2	1	2	2	1	1	1	2
SODIUM NITRATE	3	2	1	1	2	1	4	2
SODIUM PERBORATE	3	3	1	1	2	1	1	2
SODIUM PEROXIDE	3	1	2	2	2	1	1	2
SODIUM PHOSPHATES	1	3	2	1	1	1	1	2
SODIUM SALTS	4	4	4	4	1	1	1	2
SODIUM SULFATE	3	2	1	1	1	1	1	1
SODIUM SULFIDE AND SULFITE	3	3	2	3	1	1	1	1
SODIUM THIOSULFATE	3	3	1	2	2	1	1	1
SOYBEAN OIL	2	1	1	1	1	3	1	3
STANNOUS CHLORIDE (15%)	3	3	2	3	1	1	1	1
STEAM, BELOW 400 DEGEES F.	1	3	1	1	3	1*	3	3
STODDARD SOLVENT	2	1	1	1	1	3	1	2
SUCROSE SOLUTIONS	1	1	1	1	1	1	1	2
SULFUR	2	1	1	1	3	1	1	1
SULFUR LIQUORS	1	1	1	1	2	2	1	2
SULFUR (MOLTEN)	3	3	1	1	3	3	1	3
SULFUR DIOXIDE (DRY)	3	1	1	3	3	1	3	3
SULFUR TRIOXIDE (DRY)	2	2	2	3	3	2	1	3
SUNSAFE	3	1	1	1	1	3	1	2
TANNIC ACID (10%)	1	3	2	3	1	1	1	2
TAR, BITUMINOUS	2	1	1	1	2	3	1	3
TARTARIC ACID	2	3	3	2	1	2	1	2
TERPINEOL	4	4	4	4	2	3	1	3
TERTIARY BUTYL ALCOHOL	1	1	1	1	2	2	1	2
TETRACHLOROETHANE	4	2	1	2	3	3	1	3
TETRACHLOROETHYLENE	3	2	2	4	3	3	1	3
TETRAETHYL LEAD	1	1	1	1	2	3	1	2
TETRAETHYL LEAD (BLEND)	1	1	1	1	2	3	1	3
TITANIUM TETRACHLORIDE	2	1	2	3	2	3	1	3
TOLUENE	1	1	1	1	3	3	1	3
TRANSFORMER OIL	1	1	1	1	1	3	1	2
TRANSMISSION FLUID (TYPE A)	1	1	1	1	1	3	1	2
TRICHLOROETHANE	4	2	1	4	3	3	1	3
TRICHLOROETHYLENE	3	2	2	2	3	3	1	3
TRICRESYL PHOSPHATE	4	1	2	2	3	1	2	3
TURBINE OIL #15 (MIL-L-7808A)	4	2	1	1	2	3	1	3
TURPENTINE	3	2	1	1	1	3	1	3
VARNISH	1	1	1	1	2	3	1	3
WATER	1	3	1	1	1	1	2	2
WHISKEY	1	3	1	1	1	1	1	1
WINE	1	3	1	1	1	1	1	1
WOOD OIL	4	2	1	1	1	3	1	2
XYLENE	1	2	1	1	3	3	1	3
ZINC SULFATE	3	3	2	2	1	1	1	1

Ratings Code:

- G** – Good to excellent. Little or no swelling, tensile or surface changes. Preferred choice.
- L** – Marginal or conditional. Noticeable effects but not necessarily indicating lack of serviceability. Further testing suggested for specific application. Very long-term effects such as stiffening or potential for crazing should be evaluated.
- P** – Poor or unsatisfactory. Not recommended without extensive and realistic testing.
- – Indicates that this was not tested.
- # – For Teflon. Indicates good chemical resistance but potential for excessive permeation.

MEDIA	Rating
Acetaldehyde	P
Acetates	L
Acetic Acid	G
Acetic Anhydride	L
Acetone	G
Acetyl Bromide	–
Acetyl Chloride	L
Air	G
Alcohols	L
Aluminum Salts	G
Ammonia	G
Amyl Acetate	L
Aniline	G
Animal Oils	G
Arsenic Salts	L
Aromatic Hydrocarbons	–
Barium Salts	G
Benzaldehyde	L
Benzene (Benzol)	L
Benzyl Alcohol	G
Bleaching Liquors	–
Boric Acid Solution	G
Bromine	P
Butane	L
Butanol	–
Butyl Acetate	P
Calcium Salts	G
Carbon Dioxide	G
Carbon Disulfide	L
Carbon Tetrachloride	P
Caustic Potash	G
Caustic Soda	G
Chloroacetic Acid	L
Chlorine (Dry)	P
Chlorine (Wet)	P
Chlorobenzene	P
Chloroform	P
Chromic Acid	G
Copper Salts	G
Cresol	L
Cyclohexanone	L
Ethers	P
Ethyl Acetate	L
Ethyl Alcohol	G
Ethylamine	L
Ethyl Bromide	–
Ethyl Chloride	P
Fatty Acids	G
Ferric Salts	G
Formaldehyde	G
Formic Acid	G
Freon	L
Gasoline	L
Glucose	G

MEDIA	Rating
Glycerine	G
Hydriodic Acid	–
Hydrochloric Acid (Conc.)	G
Hydrochloric Acid (Med. Conc.)	G
Hydrofluoric Acid	G
Hydrogen Peroxide (Conc.)	L
Hydrogen Peroxide (Dil.)	L
Hydrogen Sulfide	G
Iodine	G
Kerosene	P
Ketones	G
Lacquer Solvent	L
Lactic Acid	G
Lead Acetate	G
Linseed Oil	G
Magnesium Salts	G
Naphtha	L
Natural Gas	L
Nickel Salts	G
Nitric Acid (Conc.)	P
Nitric Acid (Dil.)	L
Nitrobenzene	G
Nitrogen Oxides	–
Nitrous Acid	G
Oils (Animal and Mineral)	L
Oils (Vegetable)	L
Oxygen	L
Perchloric Acid	L
Phenol	G
Potassium Salts	G
Pyridine	G
Silver Nitrate	G
Soap Solutions	G
Sodium Salts	G
Stearic Acid	L
Sulfur Chloride	P
Sulfuric Acid (Conc.)	L
Sulfuric Acid (Dil.)	G
Sulfurous Acid	L
Tannic Acid	G
Tanning Extracts	L
Titanium Salts	–
Toluene (Toluol)	P
Trichloroacetic Acid	G
Trichlorethylene	P
Turpentine	P
Urea	G
Uric Acid	–
Water	G
Xylene (Xylol)	P
Zinc Chloride	G



WARNING

SAFETY GUIDE FOR SELECTING AND USING QUICK ACTION COUPLINGS AND RELATED ACCESSORIES



WARNING

DANGER: Failure or improper selection or improper use of quick action couplings or related accessories can cause death, personal injury and property damage. Possible consequences of failure or improper selection or improper use of quick action couplings or related accessories include but are not limited to:

- Couplings or parts thrown off at high speed.
- High velocity fluid discharge.
- Explosion or burning of the conveyed fluid.
- Contact with suddenly moving or falling objects that are to be held in position or moved by the conveyed fluid.
- Dangerously whipping hose.
- Contact with conveyed fluids that may be hot, cold, toxic, or otherwise injurious.
- Sparking or explosion while paint or flammable liquid spraying.

Before selecting or using any Parker quick action couplings or related accessories, it is important that you read and follow the following instructions.

1.1 Scope: This safety guide provides instructions for selecting and using (including installing connecting, disconnecting, and maintaining) quick action couplings and related accessories (including caps, plugs, blow guns, and two way valves). This safety guide is a supplement to and is to be used with, the specific Parker publications for the specific quick action couplings and related accessories that are being considered for use.

1.2 Fail-Safe: Quick action couplings or the hose they are attached to can fail without warning for many reasons. Design all systems and equipment in a fail-safe mode, so that failure of the quick action coupling or hose will not endanger persons or property.

1.3 Distribution: Provide a copy of this safety guide to each person that is responsible for selecting or using quick action coupling products. Do not select or use quick action couplings without thoroughly reading and understanding this safety guide as well as the specific Parker publications for the products considered or selected.

1.4 User Responsibility: Due to the wide variety of operating conditions and uses for quick action couplings, Parker and its distributors do not represent or warrant that any particular quick action coupling is suitable for any specific end use system. This safety guide does not analyze all technical parameters that must be considered in selecting a product. The user, through its own analysis and testing, is solely responsible for:

- Making the final selection of the quick action couplings.
- Assuring that the user's requirements are met and that the use presents no health or safety hazards.
- Providing all appropriate health and safety warnings on the equipment on which the quick action couplings are used.

1.5 Additional Questions: Call the appropriate Parker customer service department if you have any questions or require any additional information. For the telephone numbers of the appropriate customer service department, see the Parker publication for the product being considered or used.

2.0 QUICK ACTION COUPLING SELECTION INSTRUCTIONS

2.1 Pressure: Quick action couplings selection must be made so that the published rated pressure of the coupling is equal to or greater than the maximum system pressure. Surge pressures in the system higher than the rated pressure of the coupling will shorten the quick action coupling's life. Do not confuse burst pressure or other pressure values with rated pressure and do not use burst pressure or other pressure values for this purpose.

2.2 Fluid Compatibility: Quick action couplings selection must assure compatibility of the body and seal materials with the fluid media used. See the fluid compatibility chart in the Parker publication for the product being considered or used.

2.3 Temperature: Be certain that fluid and ambient temperatures, both steady and transient, do not exceed the limitations of the quick action couplings. Use caution and hand protection when connecting or disconnecting quick action couplings that are heated or cooled by the media they are conducting or by their environment.

2.4 Size: Transmission of power by means of pressurized liquid varies with pressure and rate of flow. The size of the quick action couplings and other components of the system must be adequate to keep pressure losses to a minimum and avoid damage due to heat generation or excessive fluid velocity.

2.5 Pressurized Connect or Disconnect: If connecting or disconnecting under pressure is a requirement, use only quick action couplings designed for that purpose. The rated operating pressure of a quick action coupling may not be the pressure at which it may be safely connected or disconnected.

2.6 Environment: Care must be taken to ensure that quick action couplings are either compatible with or protected from the environment (that is, surrounding conditions) to which they are exposed. Environmental conditions including but not limited to ultraviolet radiation, ozone, moisture, water, salt water, chemicals, and air pollutants can cause degradation and premature failure.

2.7 Locking Means: Ball locking quick action couplings can unintentionally disconnect if they are dragged over obstructions on the end of a hose or if the sleeve is bumped or moved enough to cause disconnect. Sleeves designed with flanges to provide better gripping for oily or gloved hands are especially susceptible to accidental disconnect and should not be used where these conditions exist. Sleeve lock or union (threaded) sleeve designs should be considered where there is a potential for accidental uncoupling.

2.8 Mechanical Loads: External forces can significantly reduce quick action couplings' life or cause failure. Mechanical loads which must be considered include excessive tensile or side loads, and vibration. Unusual applications may require special testing prior to quick action couplings selection.

2.9 Specifications and Standards: When selecting quick action couplings, government, industry, and Parker specifications must be reviewed and followed as applicable.

2.10 Vacuum: Not all quick action couplings are suitable or recommended for vacuum service. Quick action couplings used for vacuum applications must be selected to ensure that the quick actions couplings will withstand the vacuum and pressure of the system.

2.11 Fire Resistant Fluids: Some fire resistant fluids require seals other than the standard nitrile used in many quick action couplings.

2.12 Radiant Heat: Quick action couplings can be heated to destruction or loss of sealability without contact by such nearby items as hot manifolds or molten metal. The same heat source may then initiate a fire. This can occur despite the presence of cool air around the quick action couplings.

2.13 Welding and Brazing: Heating of plated parts, including quick action couplings and port adapters, above 450°F (232°C) such as during welding, brazing, or soldering may emit deadly gases and may cause coupling seal damage.

3.0 QUICK ACTION COUPLING INSTALLATION INSTRUCTIONS

3.1 Pre-Installation Inspection: Before installing a quick action coupling, visually inspect it and check for correct style, body material, seal material, and catalog number. Before final installation, coupling halves should be connected and disconnected with a sample of the mating half with which they will be used.

3.2 Quick Action Coupling Halves From Other Manufacturers

If a quick action coupling assembly is made up of one Parker half and one half from another manufacturer, the lowest pressure rating of the two halves should not be exceeded.

3.3 Fitting Installation: Use a thread sealant, lubricant, or a combination of both when assembling pipe thread joints in quick action couplings. Be sure the sealant is compatible with the system fluid or gas. To avoid system contamination, use a liquid or paste type sealant rather than a tape style. Use the flats provided to hold the quick action coupling when installing fittings. Do not use pipe wrenches or a vice on other parts of the coupling to hold it when installing or removing fittings as damage or loosening of threaded joints in the coupling assembly could result. Do not apply excessive torque to taper pipe threads because cracking or splitting of the female component can result.

3.4 Caps and Plugs: Use dust caps and plugs when quick action couplings are not coupled to exclude dirt and contamination and to protect critical surfaces from damage.

3.5 Coupling Location: Locate quick action couplings where they can be reached for connect or disconnect without exposing the operator to slipping, falling, getting sprayed, or coming in contact with hot or moving parts.

3.6 Hose Whips: Use a hose whip (a short length of hose between the tool and the coupling half) instead of rigidly mounting a coupling half on hand tools or other devices. This reduces the potential for coupling damage if the tool is dropped and provides some isolation from mechanical vibration which could cause uncoupling.

4.0 QUICK ACTION COUPLING MAINTENANCE INSTRUCTIONS

4.1 Even with proper selection and installation, quick action coupling life may be significantly reduced without a continuing maintenance program. Frequency should be determined by the severity of the application and risk potential. A maintenance program must be established and followed by the user and must include the following as a minimum:

4.2 Visual Inspection of Quick Action Couplings: Any of the following conditions require immediate shut down and replacement of the quick action coupling:

- Cracked, damaged, or corroded quick action coupling parts.
- Leaks at the fitting, valve or mating seal.
- Broken coupling mounting hardware, especially breakaway clamps.

4.3 Visual Inspection All Other: The following items must be tightened, repaired or replaced as required:

- Leaking seals or port connections.
- Remove excess dirt buildup on the coupling locking means or on the interface area of either coupling half.
- Clamps, guards, and shields.
- System fluid level, fluid type and any air entrapment.

4.4 Functional Test: Operate the system at maximum operating pressure and check for possible malfunctions and freedom from leaks. Personnel must avoid potential hazardous areas while testing and using the system.

4.5 Replacement Intervals: Specific replacement intervals must be considered based on previous service life, government or industry recommendations, or when failures could result in unacceptable downtime, damage or injury risk. See instruction 1.2 above.

Additional copies of the preceding safety information can be ordered by requesting "Safety Guide For Selecting and Using Quick Action Couplings and Related Accessories," Parker Publication No. 3800-B1.0

Contact The Quick Coupling Division, Minneapolis, MN.

1. Terms and Conditions. Seller's willingness to offer Products, or accept an order for Products, to or from Buyer is subject to these Terms and Conditions or any newer version of the terms and conditions found on-line at www.parker.com/saleterms/. Seller objects to any contrary or additional terms or conditions of Buyer's order or any other document issued by Buyer.

2. Price Adjustments; Payments. Prices stated on Seller's quote or other documentation offered by Seller are valid for 30 days, and do not include any sales, use, or other taxes unless specifically stated. Unless otherwise specified by Seller, all prices are F.C.A. Seller's facility (INCOTERMS 2010). Payment is subject to credit approval and is due 30 days from the date of invoice or such other term as required by Seller's Credit Department, after which Buyer shall pay interest on any unpaid invoices at the rate of 1.5% per month or the maximum allowable rate under applicable law.

3. Delivery Dates; Title and Risk; Shipment. All delivery dates are approximate and Seller shall not be responsible for any damages resulting from any delay. Regardless of the manner of shipment, title to any products and risk of loss or damage shall pass to Buyer upon placement of the products with the shipment carrier at Seller's facility. Unless otherwise stated, Seller may exercise its judgment in choosing the carrier and means of delivery. No deferment of shipment at Buyer's request beyond the respective dates indicated will be made except on terms that will indemnify, defend and hold Seller harmless against all loss and additional expense. Buyer shall be responsible for any additional shipping charges incurred by Seller due to Buyer's acts or omissions.

4. Warranty. Seller warrants that the Products sold hereunder shall be free from defects in material or workmanship for a period of twelve months from the date of delivery to Buyer or 2,000 hours of normal use, whichever occurs first. The prices charged for Seller's products are based upon the exclusive limited warranty stated above, and upon the following disclaimer: **DISCLAIMER OF WARRANTY: THIS WARRANTY COMPRISES THE SOLE AND ENTIRE WARRANTY PERTAINING TO PRODUCTS PROVIDED HEREUNDER. SELLER DISCLAIMS ALL OTHER WARRANTIES, EXPRESS AND IMPLIED, INCLUDING DESIGN, MERCHANTABILITY AND FITNESS FOR A PARTICULAR PURPOSE.**

5. Claims; Commencement of Actions. Buyer shall promptly inspect all Products upon delivery. No claims for shortages will be allowed unless reported to the Seller within 10 days of delivery. No other claims against Seller will be allowed unless asserted in writing within 30 days after delivery. Buyer shall notify Seller of any alleged breach of warranty within 30 days after the date the defect is or should have been discovered by Buyer. Any action based upon breach of this agreement or upon any other claim arising out of this sale (other than an action by Seller for an amount due on any invoice) must be commenced within 12 months from the date of the breach without regard to the date breach is discovered.

6. LIMITATION OF LIABILITY. UPON NOTIFICATION, SELLER WILL, AT ITS OPTION, REPAIR OR REPLACE A DEFECTIVE PRODUCT, OR REFUND THE PURCHASE PRICE. IN NO EVENT SHALL SELLER BE LIABLE TO BUYER FOR ANY SPECIAL, INDIRECT, INCIDENTAL OR CONSEQUENTIAL DAMAGES ARISING OUT OF, OR AS THE RESULT OF, THE SALE, DELIVERY, NON-DELIVERY, SERVICING, USE OR LOSS OF USE OF THE PRODUCTS OR ANY PART THEREOF, OR FOR ANY CHARGES OR EXPENSES OF ANY NATURE INCURRED WITHOUT SELLER'S WRITTEN CONSENT, EVEN IF SELLER HAS BEEN NEGLIGENT, WHETHER IN CONTRACT, TORT OR OTHER LEGAL THEORY. IN NO EVENT SHALL SELLER'S LIABILITY UNDER ANY CLAIM MADE BY BUYER EXCEED THE PURCHASE PRICE OF THE PRODUCTS.

7. User Responsibility. The user, through its own analysis and testing, is solely responsible for making the final selection of the system and Product and assuring that all performance, endurance, maintenance, safety and warning requirements of the application are met. The user must analyze all aspects of the application and follow applicable industry standards and Product information. If Seller provides Product or system options, the user is responsible for determining that such data and specifications are suitable and sufficient for all applications and reasonably foreseeable uses of the Products or systems.

8. Loss to Buyer's Property. Any designs, tools, patterns, materials, drawings, confidential information or equipment furnished by Buyer or any other items which become Buyer's property, will be considered obsolete and may be destroyed by Seller after two consecutive years have elapsed without Buyer ordering the items manufactured using such property. Seller shall not be responsible for any loss or damage to such property while it is in Seller's possession or control.

9. Special Tooling. A tooling charge may be imposed for any special tooling, including without limitation, dies, fixtures, molds and patterns, acquired to manufacture Products. Such special tooling shall be and remain Seller's property notwithstanding payment of any charges by Buyer. In no event will Buyer acquire any interest in apparatus belonging to Seller which is utilized in the manufacture of the Products, even if such apparatus has been specially converted or adapted for such manufacture and notwithstanding any charges paid by Buyer. Unless otherwise agreed, Seller shall have the right to alter, discard or otherwise dispose of any special tooling or other property in its sole discretion at any time.

10. Buyer's Obligation; Rights of Seller. To secure payment of all sums due or otherwise, Seller shall retain a security interest in the goods delivered and this agreement shall be deemed a Security Agreement under the Uniform Commercial Code. Buyer authorizes Seller as its attorney to execute and file on Buyer's behalf all documents Seller deems necessary to perfect its security interest.

11. Improper use and Indemnity. Buyer shall indemnify, defend, and hold Seller harmless from any claim, liability, damages, lawsuits, and costs (including attorney fees), whether for personal injury, property damage, patent, trademark or copyright infringement or any other claim, brought by or incurred by Buyer, Buyer's employees, or any other person, arising out of: (a) improper selection, improper application or other misuse of Products purchased by Buyer from Seller; (b) any act or omission, negligent or otherwise, of Buyer; (c) Seller's use of patterns, plans, drawings, or specifications furnished by Buyer to manufacture Product; or (d) Buyer's failure to comply with these terms and conditions. Seller shall not indemnify Buyer under any circumstance except as otherwise provided.

12. Cancellations and Changes. Orders shall not be subject to cancellation or change by Buyer for any reason, except with Seller's written consent and upon terms that will indemnify, defend and hold Seller harmless against all direct, incidental and consequential loss or damage. Seller may change product features, specifications, designs and availability with or without notice to Buyer.

13. Limitation on Assignment. Buyer may not assign its rights or obligations under this agreement without the prior written consent of Seller.

14. Force Majeure. Seller does not assume the risk and shall not be liable for delay or failure to perform any of Seller's obligations by reason of circumstances beyond the reasonable control of Seller (hereinafter "Events of Force Majeure"). Events of Force Majeure shall include without limitation: accidents, strikes or labor disputes, acts of any government or government agency, acts of nature, delays or failures in delivery from carriers or suppliers, shortages of materials, or any other cause beyond Seller's reasonable control.

15. Waiver and Severability. Failure to enforce any provision of this agreement will not waive that provision nor will any such failure prejudice Seller's right to enforce that provision in the future. Invalidation of any provision of this agreement by legislation or other rule of law shall not invalidate any other provision herein. The remaining provisions of this agreement will remain in full force and effect.

16. Termination. Seller may terminate this agreement for any reason and at any time by giving Buyer thirty (30) days written notice of termination. Seller may immediately terminate this agreement, in writing, if Buyer: (a) commits a breach of any provision of this agreement (b) appointments a trustee, receiver or custodian for all or any part of Buyer's property (c) files a petition for relief in bankruptcy on its own behalf, or by a third party (d) makes an assignment for the benefit of creditors, or (e) dissolves or liquidates all or a majority of its assets.

17. Governing Law. This agreement and the sale and delivery of all Products hereunder shall be deemed to have taken place in and shall be governed and construed in accordance with the laws of the State of Ohio, as applicable to contracts executed and wholly performed therein and without regard to conflicts of laws principles. Buyer irrevocably agrees and consents to the exclusive jurisdiction and venue of the courts of Cuyahoga County, Ohio with respect to any dispute, controversy or claim arising out of or relating to this agreement.

18. Indemnity for Infringement of Intellectual Property Rights. Seller shall have no liability for infringement of any patents, trademarks, copyrights, trade dress, trade secrets or similar rights except as provided in this Section. Seller will defend and indemnify Buyer against allegations of infringement of U.S. patents, U.S. trademarks, copyrights, trade dress and trade secrets ("Intellectual Property Rights"). Seller will defend at its expense and will pay the cost of any settlement or damages awarded in an action brought against Buyer based on an allegation that a Product sold pursuant to this Agreement infringes the Intellectual Property Rights of a third party. Seller's obligation to defend and indemnify Buyer is contingent on Buyer notifying Seller within ten (10) days after Buyer becomes aware of such allegations of infringement, and Seller having sole control over the defense of any allegations or actions including all negotiations for settlement or compromise. If a Product is subject to a claim that it infringes the Intellectual Property Rights of a third party, Seller may, at its sole expense and option, procure for Buyer the right to continue using the Product, replace or modify the Product so as to make it noninfringing, or offer to accept return of the Product and return the purchase price less a reasonable allowance for depreciation. Notwithstanding the foregoing, Seller shall have no liability for claims of infringement based on information provided by Buyer, or directed to Products delivered hereunder for which the designs are specified in whole or part by Buyer, or infringements resulting from the modification, combination or use in a system of any Product sold hereunder. The foregoing provisions of this Section shall constitute Seller's sole and exclusive liability and Buyer's sole and exclusive remedy for infringement of Intellectual Property Rights.

19. Entire Agreement. This agreement contains the entire agreement between the Buyer and Seller and constitutes the final, complete and exclusive expression of the terms of sale. All prior or contemporaneous written or oral agreements or negotiations with respect to the subject matter are herein merged.

20. Compliance with Law, U. K. Bribery Act and U.S. Foreign Corrupt Practices Act. Buyer agrees to comply with all applicable laws and regulations, including both those of the United Kingdom and the United States of America, and of the country or countries of the Territory in which Buyer may operate, including without limitation the U. K. Bribery Act, the U.S. Foreign Corrupt Practices Act ("FCPA") and the U.S. Anti-Kickback Act (the "Anti-Kickback Act"), and agrees to indemnify and hold harmless Seller from the consequences of any violation of such provisions by Buyer, its employees or agents. Buyer acknowledges that they are familiar with the provisions of the U. K. Bribery Act, the FCPA and the Anti-Kickback Act, and certifies that Buyer will adhere to the requirements thereof. In particular, Buyer represents and agrees that Buyer shall not make any payment or give anything of value, directly or indirectly to any governmental official, any foreign political party or official thereof, any candidate for foreign political office, or any commercial entity or person, for the purpose of influencing such person to purchase products or otherwise benefit the business of Seller.

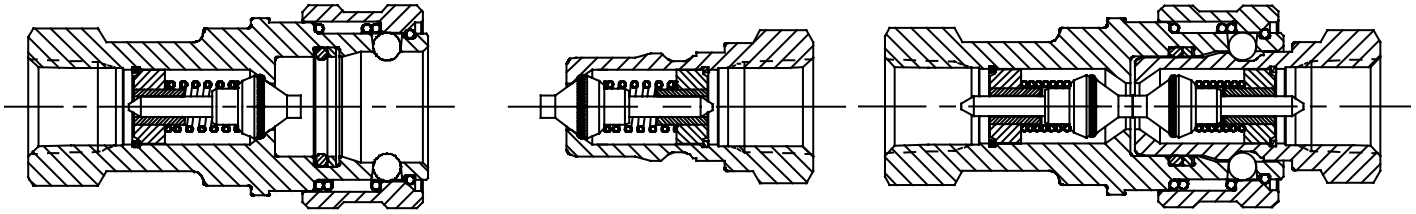

Air Inclusion: The ambient atmosphere forced into the system during the connection of the quick disconnect halves.

Break-Away: Automatic disconnection of a coupling when an axial separation force is applied.

Brinelling: Dimples or grooves worn into the shoulder of a male half by the locking balls in the female half.

Burst Pressure: The pressure at which a device loses the capability to retain pressure.

Case Hardening: Hardening the surface of low carbon steel.

Cold Flow: Continued deformation under load.

Connect Under Pressure: Ability to connect coupling halves with internal line pressure applied to either both sides or one side.

Coupling, Female Half: Other nomenclature "coupler", "socket", "body".

Coupling, Male Half: Other nomenclature "nipple", "plug", "adapter".

Coupling, Quick Disconnect: A component which can quickly join or separate a fluid line without the use of tools or special devices.

Differential Pressure (ΔP): The difference in pressure between any two points of a system or a component.

Double-Acting Sleeve: Permits push-to-connect and pull-to-disconnect convenience on implement line when female half is clamp mounted and connected with a hose.

Dust Cap: Dust or dirt repelling enclosure for both halves.

Dust Plug: Dust or dirt repelling enclosure both halves.

Flow Checking: Occurs when a nipple valve closes during flow conditions, such as when quickly lowering a heavy implement. (Also called Check Off, Back Checking or Lock-up.)

Flush Position (Valve): When the coupler valve is fully open, allowing maximum oil flow.

Force to Connect: Axial and/or rotational force required to make a complete connection.

Force to Disconnect: The reverse of the above.

Induction Hardening: Localized hardening of medium carbon steel.

Peak Pressure: Maximum momentary pressure encountered in the operation of a component.

Pressure Cap: Cap which incorporates a seal capable of withstanding the rated pressures on the male half.

Pressure Impulse Test: Subjecting a component to a specified pressure at a specified rate of increase or decrease for a specified time limit.

Pressure Operating: The pressure at which a system is operated.

Pressure Plug: Plug which incorporates a seal capable of withstanding the rated pressures on the female half.

Proof Pressure: The non-destructive test pressure in excess of the maximum rated operating pressure.

Push To Connect (Auto Lock): Locking arrangement which permits one handed connection by pushing the nipple into the coupler.

Rated Pressure: The maximum pressure at which a product is designed to operate.

Single-Acting Sleeve: Permits pull-to-disconnect convenience on implement line when female body is clamp mounted. Making connection requires manually pulling female body forward, inserting male tip, then allowing body and tip to return to original position in the clamp.

Sleeve Lock: Arrangement which provides an additional lock which must be actuated before the locking sleeve can be retracted.

Spillage: The fluid removed from the system due to disconnection of a coupling assembly. This is the fluid trapped between the mating seal and the valve seal of the coupling halves.

Surge Pressure: The pressure existing from surge conditions.

Surge Flows: A rapid increase in fluid flow.

Thermal Build-Up: Hydraulic pressure caused by expansion of the fluid due to heat from an external source such as sunlight.

Trapped Pressure: Pressurized hydraulic fluid trapped behind closed coupling valve.

Twist Lock: A locking arrangement which requires a rotational actuation to unlock the mating halves.

Types of Quick Disconnect Coupling Valve:

Straight-Thru (ST): This provides straight through flow.

Double Shut-off Valve (DSO): A valve in the female half and a valve in the male half.

Single Shut-off Valve (SSO): Generally, a valve in the female half with no valve in the male half.

NOTE: Refer to Parker's Publication No. 3800-B1.0: Safety Guide for Selecting and Using Quick Action Couplings and Related Accessories.



About Parker Hannifin Corporation

Parker Hannifin is a leading global motion-control company dedicated to delivering premier customer service. A Fortune 500 corporation listed on the New York Stock Exchange (PH), our components and systems comprise over 1,400 product lines that control motion in some 1,000 industrial and aerospace markets. Parker is the only manufacturer to 7,500 distributors serving nearly 400,000 customers worldwide.

Parker's Charter

To be a leading worldwide manufacturer of components and systems for the builders and users of durable goods. More specifically, we will design, market and manufacture products controlling motion, flow and pressure. We will achieve profitable growth through premier customer service.

Product Information

North American customers seeking product information, the location of a nearby distributor, or repair services will receive prompt attention by calling the Parker Product Information Center at our toll-free number: 1-800-C-PARKER (1-800-272-7537). In Europe, call: 00800-C-PARKER-H (00800-2727-5374).

The Aerospace Group is a leader in the development, design, manufacture and servicing of control systems and components for aerospace and related high-technology markets, while achieving growth through premier customer service.



The Climate & Industrial Controls Group designs, manufactures and markets system-control and fluid-handling components and systems to refrigeration, air-conditioning and industrial customers worldwide.



The Fluid Connectors Group designs, manufactures and markets rigid and flexible connectors, and associated products used in pneumatic and fluid systems.



The Seal Group designs, manufactures and distributes industrial and commercial sealing devices and related products by providing superior quality and total customer satisfaction.



The Hydraulics Group designs, produces and markets a full spectrum of hydraulic components and systems to builders and users of industrial and mobile machinery and equipment.



The Filtration Group designs, manufactures and markets quality filtration and clarification products, providing customers with the best value, quality, technical support, and global availability.



The Automation Group is a leading supplier of pneumatic and electromechanical components and systems to automation customers worldwide.



The Instrumentation Group is a global leader in the design, manufacture and distribution of high-quality critical flow components for worldwide process instrumentation, ultra-high-purity, medical and analytical applications.



Parker Fluid Connectors Group

North American Divisions & Distribution Service Centers

Your complete source for quality tube fittings, hose & hose fittings, brass & composite fittings, quick disconnect couplings, valves and assembly tools, locally available from a worldwide network of authorized distributors.

Fittings:

Available in inch and metric sizes covering SAE, BSP, DIN, GAZ, JIS and ISO thread configurations, manufactured from steel, stainless steel, brass, aluminum, nylon and thermoplastic.

Hose, Tubing and Bundles:

Available in a wide variety of sizes and materials including rubber, wire-reinforced, thermoplastic, hybrid and custom compounds.

Worldwide Availability:

Parker operates Fluid Connectors manufacturing locations and sales offices throughout North America, South America, Europe and Asia-Pacific.

For information, call toll free...
1-800-C-PARKER
(1-800-272-7537)

North American Divisions

Energy Products Division

Stafford, TX
phone 281 566 4500
fax 281 530 5353

Fluid System Connectors

Division
Otsego, MI
phone 269 694 9411
fax 269 694 4614

Hose Products Division

Wickliffe, OH
phone 440 943 5700
fax 440 943 3129

Industrial Hose Division

Wickliffe, OH
phone 440 833 2173
fax 440 833 2122

Parflex Division

Ravenna, OH
phone 330 296 2871
fax 330 296 8433

Quick Coupling Division

Minneapolis, MN
phone 763 544 7781
fax 763 544 3418

Tube Fittings Division

Columbus, OH
phone 614 279 7070
fax 614 279 7685

Distribution Service Centers

Buena Park, CA

phone 714 522 8840
fax 714 994 1183

Conyers, GA

phone 770 929 0330
fax 770 929 0230

Louisville, KY

phone 502 937 1322
fax 502 937 4180

Portland, OR

phone 503 283 1020
fax 503 283 2201

Toledo, OH

phone 419 878 7000
fax 419 878 7001
fax 419 878 7420
(FCG Kit Operations)

Canada

Grimsby, ONT

phone 905 945 2274
fax 905 945 3945
(Contact Grimsby for other
Service Center locations)





aerospace
 climate control
 electromechanical
 filtration
 fluid & gas handling
 hydraulics
 pneumatics
 process control
 sealing & shielding



Quick Coupling Products

Quick Couplings, Swivels, Valves,
 Diagnostic Equipment
 Catalog 3800 USA | February 2014



ENGINEERING YOUR SUCCESS.

Quick Coupling Division Locations



Minneapolis, MN



Grantsburg, WI



Chetek, WI



Union City, PA

WARNING

FAILURE OR IMPROPER SELECTION OR IMPROPER USE OF THE PRODUCTS DESCRIBED HEREIN OR RELATED ITEMS CAN CAUSE DEATH, PERSONAL INJURY AND PROPERTY DAMAGE.

- This document and other information from Parker-Hannifin Corporation, its subsidiaries and authorized distributors provide product or system options for further investigation by users having technical expertise.
- The user, through its own analysis and testing, is solely responsible for making the final selection of the system and components and assuring that all performance, endurance, maintenance, safety and warning requirements of the application are met. The user must analyze all aspects of the application, follow applicable industry standards, and follow the information concerning the product in the current product catalog and in any other materials provided from Parker or its subsidiaries or authorized distributors.
- To the extent that Parker or its subsidiaries or authorized distributors provide component or system options based upon data or specifications provided by the user, the user is responsible for determining that such data and specifications are suitable and sufficient for all applications and reasonably foreseeable uses of the components or systems.

Offer of Sale

The items described in this document are hereby offered for sale by Parker Hannifin Corporation, its subsidiaries or its authorized distributors. This offer and its acceptance are governed by the provisions stated in the "Offer of Sale."

Table of Contents

- Pneumatic Quick Couplings.....Section A**
- Hydraulic Quick Couplings.....Section B**
- Thermoplastic Couplings.....Section C**
- Swivels.....Section D**
- Valves.....Section E**
- Diagnostic Products.....Section F**

- Appendices:**
- Fluid Compatibility Chart.....I**
- Safety Guide.....VI**
- Offer of Sale.....IX**
- Glossary of Terms.....X**



Pneumatic Quick Couplings

Single Shut-Off Couplings

Single Shut-Off couplings are primarily used for pneumatic applications, connecting air tools, hoses, or other implements to compressed air supplies. They are also used with other gases, and with the exception of the E-z-mate Series can be used with low pressure fluids. The coupler half contains a shut-off valve that is automatically opened when a mating nipple is inserted and automatically closes when the nipple is removed.

Parker Single Shut-Off couplings come in three basic designs: general purpose/manual connect, general purpose/push-to-connect, and special purpose.

The standard seal material for all Parker Single Shut-Off couplers is Nitrile. Ethylene Propylene, Fluorocarbon, and Neoprene seals are available as options. See the comprehensive Fluid Compatibility Chart that provides guidelines for seal and body material selection. When there is need for further assistance in selecting the appropriate seal material, please consult the Quick Coupling Division.

General Ordering Information

When ordering Parker coupler bodies and nipples, please state the part number of each type of coupler body and each type of nipple desired. List coupler bodies and nipples as separate items rather than in combinations. Be sure to double check thread or hose sizes of items required.

Many of Parker's coupling products are available with unique non-standard options well suited to very specific applications. Examples of unusual end use applications might include: high temperatures (above 250° F), extremely caustic/corrosive solutions passing through the coupling, external/environmental corrosion situations, or other high wear and tear situations such as dragging the product along the ground. It is always recommended that the Quick Coupling Division be contacted with any questions concerning specific product application needs.

Checklist for Selecting Quick Couplings

- What are the functional requirements of the coupling?
- What is the maximum working pressure of the application?
- Which seals and body material are compatible with the system's fluid?
- Is the application static or dynamic?
- What size coupler/hose is required?
- What is the maximum pressure drop suitable for the application?
- Does the application require the ability to connect and disconnect under pressure?
- What is the media temperature and ambient temperature?
- What end configurations are required?
- Is an industry interchange coupler required?
- Is air inclusion and fluid loss a concern in the application?

Table of Contents

Introduction	A-1
Coupling Selection & Ordering Guide	A-3
Interchange Match-up Chart	A-4
General Purpose Couplings	
Industrial Interchange Nipples.....	A-5
20 Series	A-8
30 Series.....	A-11
HF Series.....	A-14
Tru-Flate Design	
10 Series.....	A-18
ARO 210 Interchange	
50 Series.....	A-22
HA Series.....	A-25
Universal Coupler (accepts Industrial Interchange, Tru-Flate, and 50 Series Nipples) UC Series.....	A-27
Lincoln “Long Stem” Interchange	
70 Series.....	A-28
European High Flow Interface	
RF Series.....	A-30
Schrader Twist-Lock Interchange	
TL Series	A-33
Special Purpose Couplings	
Snap-tite IH Design	
IH Series	A-36
Tool-Mate Series (Non-Marring)	
RF and Industrial Interchange Styles.....	A-38
Tool-Mate Series (Non-Marring, Exhaust)	
RF and Industrial Interchange Styles.....	A-40
E-z-mate Series (Exhaust)	
Industrial Interchange	A-42
GF Series	
Natural & Propane Gas	A-44

Pneumatic Coupling Selection Guide

Pneumatic Coupling Selection Guide (by Interchange)										
Body Sizes (in.)	Connection style	Material*				Locking Mechanism	Std Seal Material	Std Seal Temp Range	Rated Pressure	Coupler Series
		B	S	SS	P					
Industrial Interchange Couplers										
General Purpose										
1/4 to 1/2	Manual Sleeve	■	■	■		Ball	Nitrile	-40° to +250° F	300 psi	20 Series
1/4 to 1/2	Push-to-Connect	■	■			Ball	Nitrile	-40° to +250° F	300 psi	HF Series
1/4 to 3/4	Push-to-Connect	■				Pawl	Nitrile	-40° to +250° F	300 psi	30 Series
1/4	Push-to-Connect	■				Ball	Nitrile	-40° to +250° F	150 psi	Universal Series
Special Purpose										
1/4 & 3/8	Push-to-Connect		■		■	Fingers	Nitrile	-40° to +250° F	300 psi	Tool-Mate (PBH) (non-marring)
1/4 to 1/2	Push-to-Connect		■		■	Fingers	Nitrile	-40° to +250° F	300 psi	Tool-Mate (PBS) (non-marring, exhaust)
1/4 to 3/4	Push-to-Connect		■			Ball	Nitrile	-40° to +250° F	300 psi	E-z-mate (exhaust)
Tru-Flate Interchange Couplings										
1/4 to 1/2	Manual Sleeve	■	■			Ball	Nitrile	-40° to +250° F	300 psi	10 Series
1/4	Push-to-Connect	■				Ball	Nitrile	-40° to +250° F	150 psi	Universal Series
ARO 210 Interchange Couplings										
1/4	Manual Sleeve	■	■			Ball	Nitrile	-40° to +250° F	300 psi	50 Series
1/4	Push-to-Connect	■				Ball	Nitrile	-40° to +250° F	300 psi	HA Series
1/4	Push-to-Connect	■				Ball	Nitrile	-40° to +250° F	150 psi	Universal Series
Lincoln "Long Stem" Interchange Couplings										
1/4	Manual Sleeve	■				Ball	Nitrile	-40° to +250° F	300 psi	70 Series
Common High-Flow European Interchange Couplings										
1/4 & 3/8	Push-to-Connect	■	■			Ball	Nitrile	-40° to +250° F	300 psi	RF Series
1/4	Push-to-Connect		■		■	Fingers	Nitrile	-40° to +250° F	300 psi	Tool-Mate (PER) (non-marring)
1/4	Push-to-Connect		■		■	Fingers	Nitrile	-40° to +250° F	300 psi	Tool-Mate (PES) (non-marring, exhaust)
Schrader Twist -Lock Interchange Couplings										
1/4 & 1/2	Push-to-Connect	■	■			Cam	Nitrile	-40° to +250° F	300 psi	TL Series
Special Purpose - Natural and Propane Gas Couplings										
1/4 to 1-1/4	Manual Sleeve	■				Ball	Fluorocarbon	32° to +200° F	1/2 psi	GF Series

* Material Code: B = Brass, S = Steel, SS = Stainless Steel, P = Plastic

Optional Materials and Features:
(add code to part number)

Code	Description	Applies to
prefix B	Brass body	Nipples (std is steel) Couplers (3/8" & 1/2" sizes only)
suffix N	Stainless steel springs, locking balls & brass valves	Couplers (10, 20, 30, 50 & 70 Series)
suffix -SL	Sleeve-Lok	Couplers (10, 20, 30, 50 & 70 Series)
suffix R	Grip Ring sleeve	Couplers (10 & 20 Series)
suffix W	Ethylene Propylene seal material (-65° to + 400° F)	Couplers
suffix Y	Fluorocarbon seal material (-30° to + 400° F)	Couplers

Contact QCD for availability and additional options.
To select proper seal materials, see Fluid Compatibility Chart or contact QCD.



Popular Coupling Designs

Parker's Quick Coupling Division manufactures quick couplings to interchange with popular designs that have become accepted standards in the industry today. The actual size nipple chart below can be used to help select Parker Quick Couplings that will interchange with specific nipple designs and sizes.

10 Series (Tru-Flate Interchange)

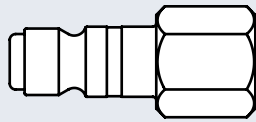

1/4" Body Size

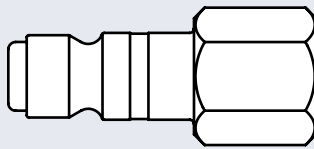

3/8" Body Size

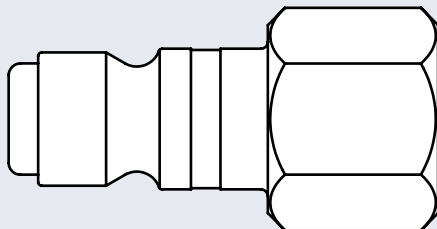

1/2" Body Size

Twist-Lock (Schrader Interchange)

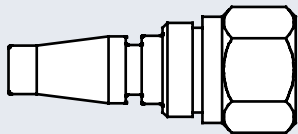

1/4" Body Size

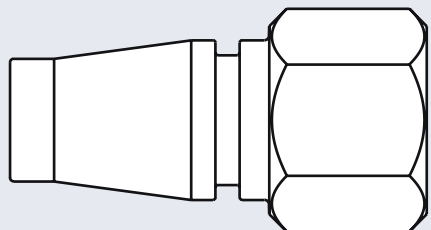

1/2" Body Size

20 Series, 30 Series, HF Series, E-z-mate (Industrial Interchange)

1/8" HF Series

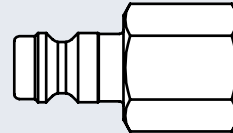

1/8" Body Size

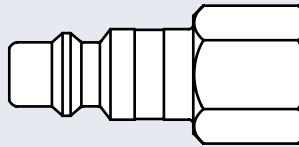

1/4" Body Size

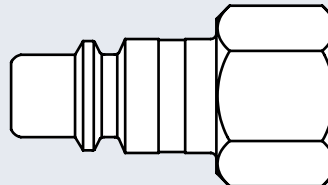

3/8" Body Size

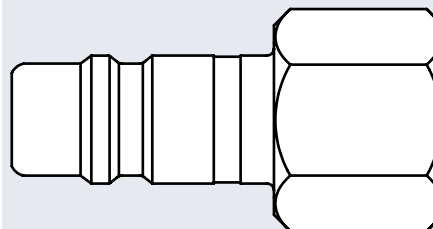

1/2" Body Size

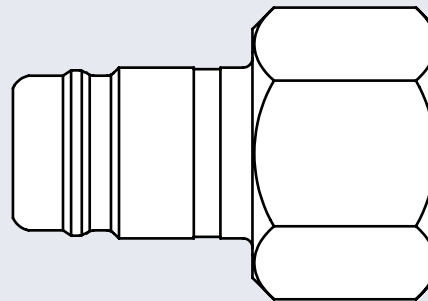

3/4" Body Size

50 Series (ARO-210 Interchange)

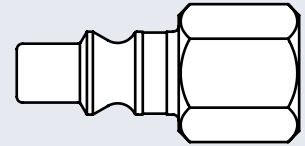

1/4" Body Size

70 Series (Lincoln Interchange)

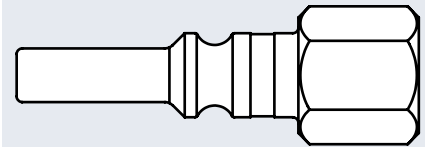

1/4" Body Size

RF Series (European Interchange)

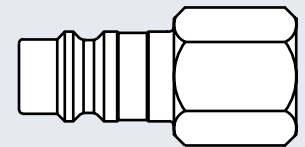

1/4" Body Size

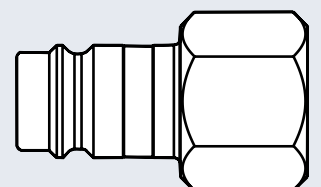

3/8" Body Size



Parker Industrial Interchange Nipples are compatible for use with 20 Series, 30 Series, HF Series, Universal or E-z-mate couplers. The standard male tip of the pneumatic industry, these nipples are interchangeable with similar nipples manufactured to the same requirements.

Features:

- Conforms to A-A-59439 (MIL-C-4109F, ISO 6150-B) requirements for global interchangeability
- Steel nipples have hardened wear points and load-bearing areas
- Unvalved style nipple mates with valved couplers

Applications include:

- Air compressors
- Pneumatic tools
- Drop-down air lines

Optional Material:

(add code to part number)

Code	Description	Part Number Example
prefix B	Brass body	BH1E

Contact QCD for availability and additional options.

Nipples- Female Pipe Thread



Body Size	Part Number Brass	Part Number Steel	Part Number Stainless Steel (303)	Thread Size	Length	Exposed Length*	Largest Diameter	Wrench Flats	Weight (lbs.)
1/4	-	H1C	-	1/8-27 NPTF	1.48	0.71	0.58	0.50	0.03
1/4	BH3C	H3C	SH3C	1/4-18 NPTF	1.56	0.80	0.72	0.62	0.05
1/4	-	H3C-E	SH3C-E	3/8-18 NPTF	1.60	0.83	0.94	0.81	0.08
3/8	-	H1E	-	1/4-18 NPTF	1.60	0.69	0.72	0.62	0.06
3/8	BH3E	H3E	-	3/8-18 NPTF	1.72	0.74	0.94	0.81	0.10
3/8	-	H3E-F	-	1/2-14 NPTF	1.89	0.90	1.16	1.00	0.13
1/2	-	H1F	-	3/8-18 NPTF	2.03	0.79	0.94	0.81	0.12
1/2	BH3F	H3F	-	1/2-14 NPTF	2.20	0.83	1.16	1.00	0.19
1/2	-	H3F-G	-	3/4-14 NPTF	2.30	1.05	1.44	1.25	0.26
3/4	-	H3G-F	-	1/2-14 NPTF	2.22	1.06	1.16	1.00	0.23
3/4	-	H3G	-	3/4-14 NPTF	2.18	1.02	1.44	1.25	0.34
3/4	-	H3G-J	-	1-11 1/2 NPTF	2.41	1.25	1.80	1.63	0.47

* This dimension represents the portion of the nipple that is exposed when the nipple is connected to a Parker 20 Series coupler.



Nipples- Male Pipe Thread



Body Size	Part Number Brass	Part Number Steel	Part Number Stainless Steel (303)	Thread Size	Length	Exposed Length*	Largest Diameter	Wrench Flats	Weight (lbs.)
1/4	-	H0C	-	1/8-27 NPTF	1.68	0.92	0.58	0.50	0.05
1/4	BH2C	H2C	SH2C	1/4-18 NPTF	1.66	0.89	0.65	0.56	0.06
1/4	-	H2C-E	SH2C-E	3/8-18 NPTF	1.90	1.14	0.80	0.69	0.07
3/8	-	H00E	-	1/8-27 NPTF	1.68	0.73	0.72	0.62	0.08
3/8	-	H0E	-	1/4-18 NPTF	1.90	0.95	0.72	0.62	0.08
3/8	BH2E	H2E	-	3/8-18 NPTF	1.90	0.95	0.80	0.69	0.09
3/8	-	H2E-F	-	1/2-14 NPTF	2.03	1.09	1.02	0.88	0.15
1/2	-	H0F	-	3/8-18 NPTF	2.20	0.96	0.79	0.69	0.16
1/2	BH2F	H2F	-	1/2-14 NPTF	2.35	1.09	1.01	0.88	0.18
1/2	-	H2F-G	-	3/4-14 NPTF	2.40	1.16	1.22	1.06	0.24
3/4	-	H2G-F	-	1/2-14 NPTF	2.32	1.16	1.16	1.00	0.22
3/4	BH2G	H2G	-	3/4-14 NPTF	2.28	1.12	1.22	1.06	0.28
3/4	-	H2G-J	-	1-11 1/2 NPTF	2.56	1.40	1.52	1.31	0.36

Nipples- Standard Hose Barb



Body Size	Part Number Brass	Part Number Steel	Part Number Stainless Steel (303)	Hose I.D.	Length	Exposed Length*	Largest Diameter	Weight (lbs.)
1/4	-	H8C	-	1/4	1.72	0.95	0.46	0.04
1/4	-	-	SH8C	1/4	2.09	1.33	0.56	0.04
1/4	-	H8C-D	-	5/16	1.96	1.20	0.50	0.04
1/4	-	H9C	SH9C	3/8	1.96	1.20	0.50	0.05
3/8	-	H5E	-	3/8	1.85	0.90	0.59	0.07
3/8	-	H6E	-	1/2	2.09	1.14	0.68	0.08
1/2	-	H4F	-	3/8	2.36	1.12	0.66	0.10
1/2	-	H5F	-	1/2	2.36	1.12	0.66	0.11
1/2	-	H5F-G	-	3/4	2.95	1.71	0.87	0.18
3/4	-	H5G-F	-	1/2	2.47	1.31	0.93	0.19
3/4	BH5G	H5G	-	3/4	3.00	1.84	0.93	0.25
3/4	-	H5G-J	-	1	3.24	2.08	1.24	0.36

* This dimension represents the portion of the nipple that is exposed when the nipple is connected to a Parker 20 Series coupler.

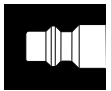

Nipples- Push-Lok Hose Barb**



Body Size	Part Number Brass	Part Number Steel	Hose I.D.	Length	Exposed Length*	Largest Diameter	Weight (lbs.)
1/4	BH8CP	H8CP	1/4	1.74	0.97	0.69	0.04
1/4	-	H9CP	3/8	1.96	1.19	0.86	0.05
3/8	-	H4EP	1/4	1.87	0.92	0.69	0.06
3/8	-	H5EP	3/8	2.02	1.07	0.86	0.07
3/8	-	H6EP	1/2	2.21	1.27	0.97	0.09
1/2	-	H4FP	3/8	2.36	1.11	0.86	0.11
1/2	-	H5FP	1/2	2.48	1.24	0.97	0.11
1/2	-	H6FP	5/8	2.95	1.71	1.14	0.14

* This dimension represents the portion of the nipple that is exposed when the nipple is connected to a Parker 20 Series coupler.

**Push-Lok hose barbs are designed for use with Parker Push-Lok hose and do not require clamps.



20 Series Pneumatic Couplers mate with Industrial Interchange nipples, the standard male tip of the pneumatic industry. Available options include Sleeve-Lok, stainless steel locking balls and springs, and grip-ring sleeve.

Features:

- Mates with Industrial Interchange nipples manufactured to A-A-59439 (MIL-C-4109F, ISO 6150-B) global standards
- 1/4" body size has a brass body and steel valve, 3/8" body size has all steel construction
- Tubular valve delivers high flow with minimal pressure drop
- Integral sleeve guard resists accidental disconnection
- Standard seal is Nitrile

Applications:

- Air compressors
- Pneumatic tools
- Water
- Grease
- Paint

Performance

20 Series (1/4", 3/8", 1/2" sizes)

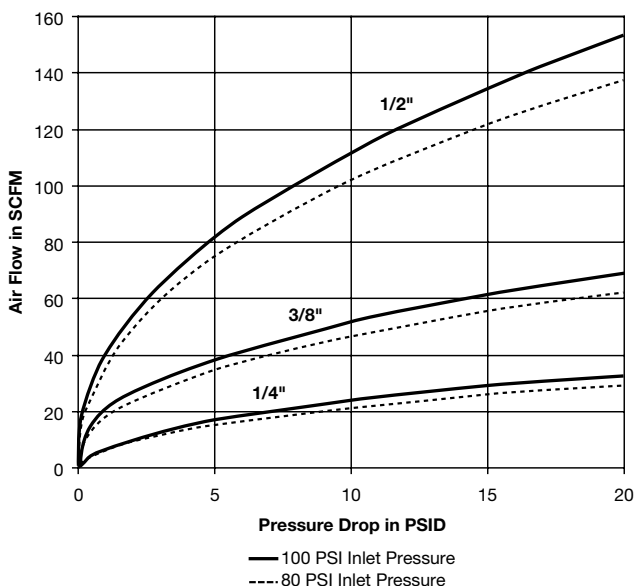

20 Series Specifications

Body Size	1/4	3/8	1/2
Rated Pressure (psi)	300		
Temperature Range (std seals)	-40° to +250° F		
Locking Device	4 balls	8 balls	8 balls
Vacuum Data (in. Hg.)	—		
Disconnected (coupler only)	Not Recommended		
Connected	27.4		

Repair Kits

Body Size	Seal Material	Part No.
1/4	Nitrile	21K
1/4	Ethylene Propylene	21KW
1/4	Fluorocarbon	21KY
3/8	Nitrile	14K
3/8	Ethylene Propylene	14KW
3/8	Fluorocarbon	14KY
1/2	Nitrile	16K
1/2	Ethylene Propylene	16KW
1/2	Fluorocarbon	16KY
3/4	Nitrile	38K
3/4	Ethylene Propylene	38KW
3/4	Fluorocarbon	38KY



Couplers- Female Pipe Thread

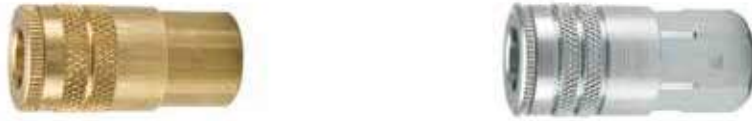

Body Size	Part Number Brass	Part Number Steel	Part Number Stainless Steel (303)	Thread Size	Length	Largest Diameter	Wrench Flats	Weight (lbs.)
1/4	B23A	-	-	1/8-27 NPTF	1.83	0.90	0.75	0.20
1/4	B23	-	S23	1/4-18 NPTF	1.83	0.90	0.75	0.19
1/4	B23E	-	-	3/8-18 NPTF	1.95	0.94	0.81	0.20
3/8	-	25C	-	1/4-18 NPTF	2.22	1.06	0.88	0.30
3/8	B25	25	-	3/8-18 NPTF	2.28	1.06	0.88	0.32
3/8	-	25F	-	1/2-14 NPTF	2.55	1.16	1.00	0.34
1/2	-	17E	-	3/8-18 NPTF	2.74	1.19	1.00	0.46
1/2	B17	17	-	1/2-14 NPTF	2.96	1.19	1.00	0.50
1/2	-	17G	-	3/4-14 NPTF	3.19	1.44	1.25	0.56

Couplers- Male Pipe Thread



Body Size	Part Number Brass	Part Number Steel	Part Number Stainless Steel (303)	Thread Size	Length	Largest Diameter	Wrench Flats	Weight (lbs.)
1/4	B22A	-	-	1/8-27 NPTF	1.89	0.90	0.75	0.18
1/4	B22	-	S22	1/4-18 NPTF	2.05	0.90	0.75	0.18
1/4	B22E	-	-	3/8-18 NPTF	2.08	0.90	0.75	0.19
3/8	-	24C	-	1/4-18 NPTF	2.36	1.06	0.88	0.26
3/8	B24	24	-	3/8-18 NPTF	2.39	1.06	0.88	0.29
3/8	-	24F	-	1/2-14 NPTF	2.55	1.16	0.88	0.29
1/2	-	16E	-	3/8-18 NPTF	2.93	1.19	1.00	0.42
1/2	B16	16	-	1/2-14 NPTF	3.08	1.19	1.00	0.47
1/2	-	16G	-	3/4-14 NPTF	3.21	1.30	1.13	0.56

Optional Materials and Features:

(add code to part number)

Code	Description	Part Number Example
prefix B	Brass body (Couplers - 3/8" & 1/2" sizes only)	B24C
suffix N	Stainless steel springs, locking balls & brass valves (Couplers)	B24N
suffix -SL	Sleeve-Lok (Couplers)	24-SL
suffix R	Grip Ring sleeve (Couplers)	24R
suffix W	Ethylene Propylene seal material (-65° to + 400° F) (Couplers)	24W
suffix Y	Fluorocarbon seal material (-30° to + 400° F) (Couplers)	24Y

Contact QCD for availability and additional options.
To select proper seal materials, see Fluid Compatibility Chart or contact QCD.



Couplers- Standard Hose Barb



Body Size	Part No. Brass	Part No. Steel	Hose I.D.	Length	Largest Diameter	Wrench Flats	Weight (lbs.)
1/4	B20-3B	-	1/4	2.49	0.90	0.75	0.18
1/4	B20-4B	-	5/16	2.49	0.90	0.75	0.18
1/4	B20-5B	-	3/8	2.49	0.90	0.75	0.18
3/8	-	24-5B	3/8	2.60	1.06	0.88	0.27
3/8	-	24-6B	1/2	2.60	1.06	0.88	0.28
1/2	-	16-5B	3/8	3.14	1.19	1.00	0.41
1/2	-	16-6B	1/2	3.14	1.19	1.00	0.43
1/2	-	16-7B	3/4	3.60	1.19	1.00	0.48

Couplers- Push-Lok Hose Barb*



Body Size	Part No. Brass	Part No. Steel	Hose I.D.	Length	Largest Diameter	Wrench Flats	Weight (lbs.)
1/4	B20-3BP	-	1/4	2.32	0.90	0.75	0.18
1/4	B20-5BP	-	3/8	2.47	0.90	0.75	0.19
3/8	-	24-5BP	3/8	2.88	1.06	0.88	0.27
1/2	-	16-5BP	3/8	3.35	1.19	1.00	0.41
1/2	-	16-6BP	1/2	3.46	1.19	1.00	0.43

* Push-Lok hose barbs are designed for use with Parker Push-Lok hose and do not require clamps.

NOTE: See Table of Contents for pneumatic Industrial Interchange nipples used with 20 Series couplers.

Pneumatic Quick Couplings - General Purpose

30 Series Couplers Accepts Industrial Interchange Nipples

Push-to-connect sleeve, single shut off



30 Series Pneumatic Couplers mate with Industrial Interchange nipples, the standard male tip of the pneumatic industry. The couplers have brass bodies. Standard seal is Nitrile.

Features:

- Mates with Industrial Interchange nipples manufactured to A-A-59439 (MIL-C-4109F, ISO 6150-B) global standards
- Tubular valve delivers high flow with minimal pressure drop
- Push-to-connect operation
- Options include Sleeve-Lok, brass valve for added corrosion resistance, and alternative seal materials

Applications include:

- Air compressors
- Pneumatic tools
- Water
- Grease
- Paint

Performance 30 Series (1/4" & 3/8" sizes)

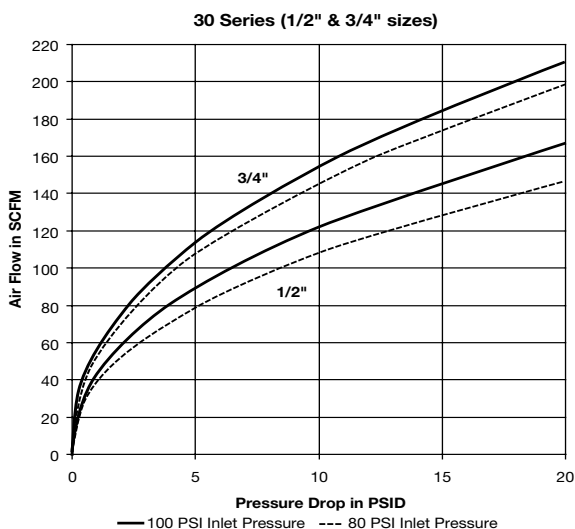
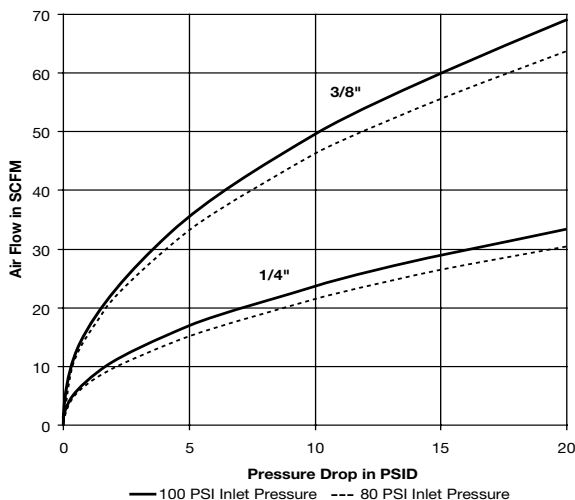

30 Series Specifications

Body Size	1/4	3/8	1/2	3/4
Rated Pressure (psi)	300			
Temperature Range (std seals)	-40° to +250° F			
Locking Device	3 pawls	3 pawls	6 pawls	6 pawls
Vacuum Data (in. Hg.)	—			
Disconnected (coupler only)	Not Recommended			
Connected	27.4			

Repair Kits

Body Size	Seal Material	Part No.
1/4	Nitrile	21K
1/4	Ethylene Propylene	21KW
1/4	Fluorocarbon	21KY
3/8	Nitrile	14K
3/8	Ethylene Propylene	14KW
3/8	Fluorocarbon	14KY
1/2	Nitrile	16K
1/2	Ethylene Propylene	16KW
1/2	Fluorocarbon	16KY
3/4	Nitrile	38K
3/4	Ethylene Propylene	38KW
3/4	Fluorocarbon	38KY



Couplers- Female Pipe Thread



Body Size	Part No. Brass	Thread Size	Length	Largest Diameter	Wrench Flats	Weight (lbs)
1/4	B33A	1/8-27 NPTF	1.96	1.20	0.75	0.30
1/4	B33	1/4-18 NPTF	1.96	1.20	0.75	0.28
1/4	B33E	3/8-18 NPTF	2.03	1.20	0.81	0.30
3/8	B35C	1/4-18 NPTF	2.26	1.39	0.88	0.42
3/8	B35	3/8-18 NPTF	2.33	1.39	0.88	0.42
3/8	B35F	1/2-14 NPTF	2.57	1.39	1.00	0.46
1/2	B37E	3/8-18 NPTF	2.76	1.52	1.00	0.56
1/2	B37	1/2-14 NPTF	3.00	1.52	1.00	0.66
1/2	B37G	3/4-14 NPTF	3.12	1.52	1.25	0.73
3/4	B39F	1/2-14 NPTF	2.85	1.90	1.31	0.15
3/4	B39	3/4-14 NPTF	2.99	1.90	1.31	1.10
3/4	B39J	1-11 1/2 NPTF	3.18	1.90	1.63	1.24

Couplers- Male Pipe Thread



Body Size	Part No. Brass	Thread Size	Length	Largest Diameter	Wrench Flats	Weight (lbs)
1/4	B32A	1/8-27 NPTF	2.03	1.20	0.75	0.27
1/4	B32	1/4-18 NPTF	2.18	1.20	0.75	0.28
1/4	B32E	3/8-18 NPTF	2.18	1.20	0.75	0.28
3/8	B34C	1/4-18 NPTF	2.38	1.39	0.88	0.36
3/8	B34	3/8-18 NPTF	2.44	1.39	0.88	0.39
3/8	B34F	1/2-14 NPTF	2.57	1.39	0.88	0.41
1/2	B36E	3/8-18 NPTF	2.92	1.52	1.00	0.58
1/2	B36	1/2-14 NPTF	3.09	1.52	1.00	0.61
1/2	B36G	3/4-14 NPTF	3.12	1.52	1.13	0.67
3/4	B38	3/4-14 NPTF	2.95	1.90	1.31	0.91
3/4	B38J	1-11 1/2 NPTF	3.12	1.90	1.31	0.99



Couplers- Standard Hose Barb



Body Size	Part No. Brass	Hose I.D.	Length	Largest Diameter	Wrench Flats	Weight (lbs)
1/4	B30-3B	1/4	2.62	1.20	0.75	0.27
1/4	B30-4B	5/16	2.62	1.20	0.75	0.27
1/4	B30-5B	3/8	2.62	1.20	0.75	0.28
3/8	B34-5B	3/8	2.65	1.39	0.88	0.39
3/8	B34-6B	1/2	2.65	1.39	0.88	0.41
1/2	B36-6B	1/2	3.13	1.52	1.00	0.59
1/2	B36-7B	3/4	3.60	1.52	1.00	0.65
3/4	B38-7B	3/4	3.69	1.90	1.31	0.93
3/4	B38-8B	1	3.93	1.90	1.31	1.03

Couplers- Push Lok Hose Barb*



Body Size	Part No. Brass	Hose I.D.	Length	Largest Diameter	Wrench Flats	Weight (lbs)
1/4	B30-3BP	1/4	2.45	1.20	0.75	0.27
1/4	B30-5BP	3/8	2.60	1.20	0.75	0.29
3/8	B34-5BP	3/8	2.82	1.39	0.88	0.40
1/2	B36-6BP	1/2	3.46	1.52	1.00	0.56

* Push-Lok hose barbs are designed for use with Parker Push-Lok hose and do not require clamps.

Optional Materials and Features:

(add code to part number)

Code	Description	Part Number Example
suffix N	Stainless steel springs, locking balls & brass valves (Couplers)	B34N
suffix -SL	Sleeve-Lok (Couplers)	B34-SL
suffix W	Ethylene Propylene seal material (-65° to + 400° F) (Couplers)	B34W
suffix Y	Fluorocarbon seal material (-30° to + 400° F) (Couplers)	B34Y

Contact QCD for availability and additional options.

To select proper seal materials, see Fluid Compatibility Chart or contact QCD.

Pneumatic Quick Couplings

General Purpose

HF Series Couplers

Accepts Industrial Interchange Nipples

Push-to-connect sleeve, single shut off

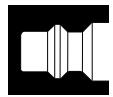

A Pneumatics



HF Series Pneumatic Quick Couplers connect with Industrial Interchange nipples, the standard male tip of the pneumatic industry. Couplers have brass construction, a corrosion resistant valve, stainless steel locking balls and a stainless valve spring.

Features:

- Integral sleeve guard protects against accidental disconnection
- Push-to-connect operation
- Slim profile
- Optional heavy duty version in solid steel

Applications include:

- Air compressors
- Pneumatic tools
- Drop-down air lines

Performance

HF Series (1/8" & 1/4" sizes)

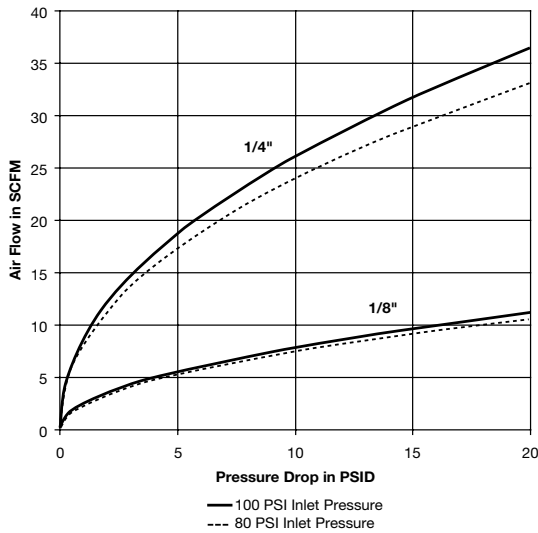

HF Series (3/8" & 1/2" sizes)

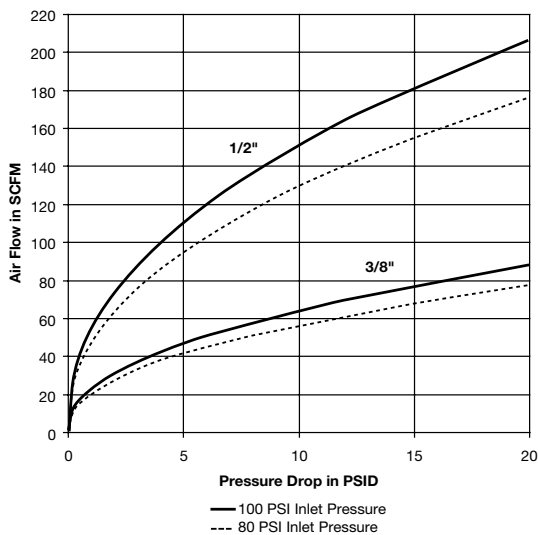

HF Series Specifications

Body Size	1/8	1/4	3/8	1/2
Rated Pressure (psi)	250	300	300	300
Temperature Range (std seals)	-40° to +250° F			
Locking Device	5 balls	4 balls	6 balls	8 balls
Vacuum Data (in. Hg.)				
Disconnected (coupler only)	Not Recommended			
Connected	—	27.4		

How To Order

HF - 251 - 4 FP - * - S

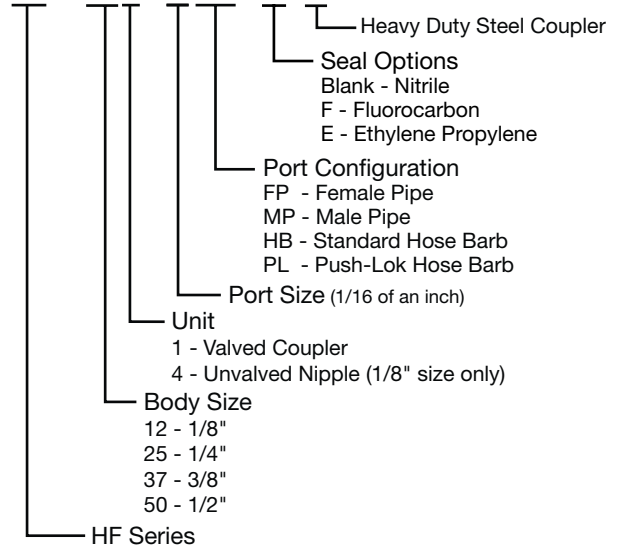



1/8" Body Size Couplers - Female Pipe Thread



Body Size	Part No. Brass	Thread Size	Length	Largest Diameter	Wrench Flats	Weight (lbs.)
1/8	HF-121-2FP	1/8-27 NPTF	1.42	0.63	0.55	0.06
1/8	HF-121-4FP	1/4-18 NPTF	1.81	0.63	0.67	0.10

1/8" Body Size Couplers - Male Pipe Thread



Body Size	Part No. Brass	Thread Size	Length	Largest Diameter	Wrench Flats	Weight (lbs.)
1/8	HF-121-2MP	1/8-27 NPTF	1.50	0.63	0.55	0.06
1/8	HF-121-4MP	1/4-18 NPTF	1.61	0.63	0.55	0.07

1/8" Body Size Nipples - Female Pipe Thread



Body Size	Part No. Brass	Thread Size	Length	Largest Diameter	Wrench Flats	Weight (lbs.)
1/8	HF-124-2FP	1/8-27 NPTF	1.08	0.58	0.50	0.03
1/8	HF-124-4FP	1/4-18 NPTF	1.34	0.78	0.67	0.07

1/8" Body Size Nipples - Male Pipe Thread



Body Size	Part No. Brass	Thread Size	Length	Largest Diameter	Wrench Flats	Weight (lbs.)
1/8	HF-124-2MP	1/8-27 NPTF	1.06	0.51	0.44	0.03
1/8	HF-124-4MP	1/4-18 NPTF	1.25	0.63	0.56	0.05

Optional Seal Materials:
(add code to part number)

Code	Description	Part Number Example
suffix W	Ethylene Propylene seal material (-65° to + 400° F) (Couplers)	HF-371-4FPW
suffix Y	Fluorocarbon seal material (-30° to + 400° F) (Couplers)	HF-371-4FPY

Contact QCD for availability and additional options.
To select proper seal materials, see Fluid Compatibility Chart or contact QCD.



1/4, 3/8, 1/2" Body Size Couplers - Female Pipe Thread



Body Size	Part No. Brass	Thread Size	Length	Largest Diameter	Wrench Flats	Weight (lbs.)
1/4	HF-251-4FP	1/4-18 NPSF	2.19	0.99	0.81	0.26
1/4	HF-251-6FP	3/8-18 NPSF	2.34	0.99	0.81	0.27
3/8	HF-371-4FP	1/4-18 NPSF	2.33	1.07	0.94	0.33
3/8	HF-371-6FP	3/8-18 NPSF	2.33	1.07	0.94	0.31
3/8	HF-371-8FP	1/2-14 NPTF	2.49	1.07	1.00	0.35
1/2	HF-501-8FP	1/2-14 NPTF	3.35	1.19	1.06	0.60

1/4, 3/8, 1/2" Body Size Couplers - Male Pipe Thread



Body Size	Part No. Brass	Thread Size	Length	Largest Diameter	Wrench Flats	Weight (lbs.)
1/4	HF-251-4MP	1/4-18 NPTF	2.34	0.99	0.81	0.25
1/4	HF-251-6MP	3/8-18 NPTF	2.37	0.99	0.81	0.26
3/8	HF-371-4MP	1/4-18 NPTF	2.49	1.07	0.94	0.32
3/8	HF-371-6MP	3/8-18 NPTF	2.52	1.07	0.94	0.3
3/8	HF-371-8MP	1/2-14 NPTF	2.68	1.07	0.94	0.33
1/2	HF-501-8MP	1/2-14 NPTF	3.48	1.19	1.06	0.57

1/4, 3/8" Body Size Couplers - Standard Hose Barb



Body Size	Part No. Brass	Hose I.D.	Length	Largest Diameter	Wrench Flats	Weight (lbs.)
1/4	HF-251-4HB	1/4	2.81	0.99	0.81	0.26
1/4	HF-251-6HB	3/8	2.81	0.99	0.81	0.27
3/8	HF-371-6HB	3/8	3.02	1.07	0.94	0.31
3/8	HF-371-8HB	1/2	3.02	1.07	0.94	0.34

1/4, 3/8" Body Size Couplers - Push-Lok Hose Barb*



Body Size	Part No. Brass	Hose I.D.	Length	Largest Diameter	Wrench Flats	Weight (lbs.)
1/4	HF-251-4PL	1/4	2.64	0.99	0.81	0.26
1/4	HF-251-6PL	3/8	2.78	0.99	0.81	0.27
3/8	HF-371-6PL	3/8	3.02	1.07	0.94	0.33
3/8	HF-371-8PL	1/2	3.07	1.07	0.94	0.31

* Push-Lok hose barbs are designed for use with Parker Push-Lok hose and do not require clamps.



Heavy Duty Couplers - Female Pipe Thread



Body Size	Part No. Steel	Thread Size	Length	Largest Diameter	Wrench Flats	Weight (lbs.)
1/4	HF-251-4FP-S	1/4-18 NPSF	2.19	0.99	0.81	0.26
1/4	HF-251-6FP-S	3/8-18 NPSF	2.34	0.99	0.81	0.27
3/8	HF-371-4FP-S	1/4-18 NPSF	2.33	1.07	0.94	0.33
3/8	HF-371-6FP-S	3/8-18 NPSF	2.33	1.07	0.94	0.31
3/8	HF-371-8FP-S	1/2-14 NPTF	2.49	1.07	1.00	0.35

Heavy Duty Couplers - Male Pipe Thread



Body Size	Part No. Steel	Thread Size	Length	Largest Diameter	Wrench Flats	Weight (lbs.)
1/4	HF-251-4MP-S	1/4-18 NPTF	2.34	0.99	0.81	0.25
1/4	HF-251-6MP-S	3/8-18 NPTF	2.37	0.99	0.81	0.26
3/8	HF-371-4MP-S	1/4-18 NPTF	2.49	1.07	0.94	0.32
3/8	HF-371-6MP-S	3/8-18 NPTF	2.52	1.07	0.94	0.30
3/8	HF-371-8MP-S	1/2-14 NPTF	2.68	1.07	0.94	0.33

Heavy Duty Couplers - Standard Hose Barb



Body Size	Part No. Steel	Hose I.D.	Length	Largest Diameter	Wrench Flats	Weight (lbs.)
1/4	HF-251-4HB-S	1/4	2.81	0.99	0.81	0.26
1/4	HF-251-6HB-S	3/8	2.81	0.99	0.81	0.27
3/8	HF-371-6HB-S	3/8	3.02	1.07	0.94	0.31
3/8	HF-371-8HB-S	1/2	3.02	1.07	0.94	0.34

Heavy Duty Couplers - Push-Lok Hose Barb*



Body Size	Part No. Steel	Hose I.D.	Length	Largest Diameter	Wrench Flats	Weight (lbs.)
1/4	HF-251-4PL-S	1/4	2.64	0.99	0.81	0.26
1/4	HF-251-6PL-S	3/8	2.78	0.99	0.81	0.27
3/8	HF-371-6PL-S	3/8	3.02	1.07	0.94	0.33
3/8	HF-371-8PL-S	1/2	3.07	1.07	0.94	0.31

* Push-Lok hose barbs are designed for use with Parker Push-Lok hose and do not require clamps.

Pneumatic Quick Couplings

General Purpose

10 Series Couplers

Tru-Flate Design

Manual sleeve, single shut off



A Pneumatics



Parker's 10 Series Pneumatic Couplers are the original Tru-Flate design. 1/4" body size has a brass body, while standard 3/8" and 1/2" body sizes have all steel construction. Sleeve options include Sleeve-Lok and Grip-Ring sleeve .

Features:

- Integral sleeve guard resists accidental disconnection
- Tubular valve delivers high air flow with minimal pressure drop
- 3/8" and 1/2" size options include brass body with steel sleeve
- Brass body option with stainless steel springs and locking balls is available for added corrosion resistance
- Standard seal is Nitrile

Applications include:

- Air compressors
- Pneumatic tools
- Water
- Grease
- Paint

Performance 10 Series (1/4", 3/8", 1/2" sizes)

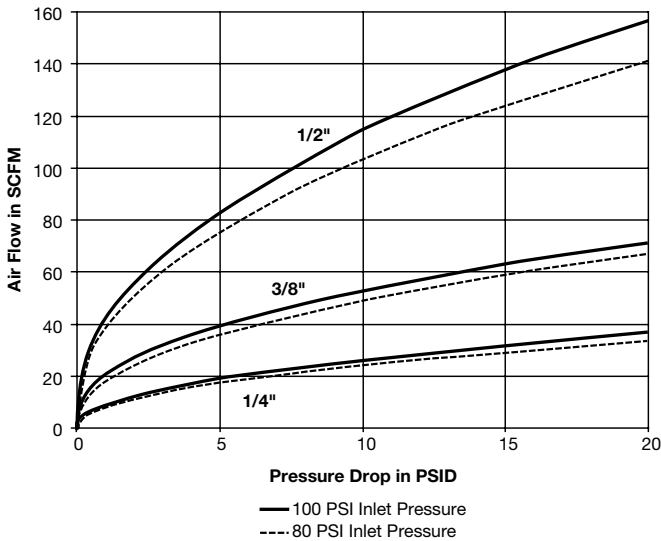

Optional Materials and Features:

(add code to part number)

Code	Description	Part Number Example
prefix B	Brass body (Couplers - 3/8" & 1/2" sizes only)	B14F
suffix N	Stainless steel springs, locking balls & brass valves (Couplers)	B15N
suffix -SL	Sleeve-Lok (Couplers)	15-SL
suffix R	Grip Ring sleeve (Couplers)	15R
suffix W	Ethylene Propylene seal material (-65° to + 400° F) (Couplers)	B15W
suffix Y	Fluorocarbon seal material (-30° to + 400° F) (Couplers)	B15Y

Contact QCD for availability and additional options.

To select proper seal materials, see Fluid Compatibility Chart or contact QCD.

10 Series Specifications			
Body Size	1/4	3/8	1/2
Rated Pressure (psi)	300		
Temperature Range (std seals)	-40° to +250° F		
Locking Device	4 balls	8 balls	8 balls
Vacuum Data (in. Hg.)	—		
Disconnected (coupler only)	Not Recommended		
Connected	27.4		

Repair Kits		
Body Size	Seal Material	Part No.
1/4	Nitrile	21K
1/4	Ethylene Propylene	21KW
1/4	Fluorocarbon	21KY
3/8	Nitrile	14K
3/8	Ethylene Propylene	14KW
3/8	Fluorocarbon	14KY
1/2	Nitrile	16K
1/2	Ethylene Propylene	16KW
1/2	Fluorocarbon	16KY





Nipples- Female Pipe Thread



Body Size	Part No. Brass	Part No. Steel	Thread Size	Length	Exposed Length**	Largest Diameter	Wrench Flats	Weight (lbs)
1/4	-	1C	1/8-27 NPTF	1.28	0.55	0.58	0.50	0.05
1/4	B3C	3C	1/4-18 NPTF	1.47	0.74	0.72	0.62	0.05
1/4	-	3C-E	3/8-18 NPTF	1.50	0.77	0.94	0.81	0.07
3/8	-	1E	1/4-18 NPTF	1.60	0.67	0.72	0.62	0.07
3/8	-	3E	3/8-18 NPTF	1.68	0.77	0.94	0.81	0.10
1/2	-	1F	3/8-18 NPTF	2.05	0.83	0.94	0.81	0.13
1/2	-	3F	1/2-14 NPTF	2.27	1.05	1.16	1.00	0.18
1/2	-	H3F-G	3/4-14 NPTF	2.38	1.13	1.44	1.25	0.26

Nipples- Male Pipe Thread



Body Size	Part No. Brass	Part No. Steel	Part No. Stainless	Thread Size	Length	Exposed Length**	Largest Diameter	Wrench Flats	Weight (lbs)
1/4	-	0C		1/8-27 NPTF	1.47	0.74	0.58	0.50	0.04
1/4	B2C	2C	S2C	1/4-18 NPTF	1.62	0.89	0.65	0.56	0.06
1/4	-	2C-E	-	3/8-18 NPTF	1.72	0.99	0.80	0.69	0.05
3/8	-	0E	-	1/4-18 NPTF	1.88	0.95	0.72	0.62	0.08
3/8	-	2E	-	3/8-18 NPTF	1.90	0.98	0.80	0.69	0.09
1/2	-	0F	-	3/8-18 NPTF	2.33	1.12	0.79	0.69	0.13
1/2	-	2F	-	1/2-14 NPTF	2.48	1.27	1.01	0.88	0.17
1/2	-	H2F-G	-	3/4-14 NPTF	2.53	1.29	1.30	1.13	0.24

Nipples- Standard Hose Barb



Body Size	Part No. Steel	Hose I.D.	Length	Exposed Length**	Largest Diameter	Weight (lbs)
1/4	8C	1/4	1.63	.090	0.45	0.04
1/4	9C	3/8	2.00	1.27	0.55	0.05
3/8	5E	3/8	1.81	0.98	0.59	0.07
1/2	H4F	3/8	2.36	1.29	0.66	0.08
1/2	5F	1/2	2.36	1.60	0.66	0.11
1/2	H5F-G	3/4	2.95	1.91	0.87	0.18

**This dimension represents portion of nipple that is exposed when nipple is inserted in a Parker 10 Series coupler



Nipples- Push-Lok Hose Barb*



Body Size	Part No. Steel	Hose I.D.	Length	Exposed Length**	Largest Diameter	Weight (lbs)
1/4	8CP	1/4	1.66	0.93	0.45	0.04
1/4	9CP	3/8	1.98	1.25	0.86	0.05
3/8	5EP	3/8	1.98	1.06	0.59	0.08
1/2	H4FP	3/8	2.52	1.27	0.86	0.11
1/2	H5FP	1/2	2.66	1.42	0.97	0.11

* Push-Lok hose barbs are designed for use with Parker Push-Lok hose and do not require clamps.

**This dimension represents portion of nipple that is exposed when nipple is inserted in a Parker 10 Series coupler

Couplers- Female Pipe Thread



Body Size	Part No. Brass	Part No. Steel	Thread Size	Length	Largest Diameter	Wrench Flats	Weight (lbs)
1/4	B13A	-	1/8-27 NPTF	1.83	0.90	0.75	0.19
1/4	B13	-	1/4-18 NPTF	1.83	0.90	0.75	0.19
1/4	B13E	-	3/8-18 NPTF	1.95	0.94	0.81	0.31
3/8	-	15C	1/4-18 NPTF	2.22	1.06	0.88	0.30
3/8	B15*	15	3/8-18 NPTF	2.28	1.06	0.88	0.34
3/8	-	15F	1/2-14 NPTF	2.55	1.16	1.00	0.46
1/2	-	17E	3/8-18 NPTF	2.74	1.19	1.00	0.46
1/2	B17*	17	1/2-14 NPTF	2.96	1.19	1.00	0.50
1/2	-	17G	3/4-14 NPTF	3.19	1.44	1.25	0.20

* Coupler has brass body and steel sleeve.

Couplers- Male Pipe Thread



Body Size	Part No. Brass	Part No. Steel	Thread Size	Length	Largest Diameter	Wrench Flats	Weight (lbs)
1/4	B12A	-	1/8-27 NPTF	1.89	0.90	0.75	0.17
1/4	B12	-	1/4-18 NPTF	2.05	0.90	0.75	0.18
1/4	B12E	-	3/8-18 NPTF	2.08	0.90	0.75	0.19
3/8	-	14C	1/4-18 NPTF	2.36	1.06	0.88	0.26
3/8	B14*	14	3/8-18 NPTF	2.39	1.06	0.88	0.27
3/8	-	14F	1/2-14 NPTF	2.55	1.06	0.88	0.28
1/2	-	16E	3/8-18 NPTF	2.93	1.19	1.00	0.42
1/2	B16*	16	1/2-14 NPTF	3.08	1.19	1.00	0.45
1/2	-	16G	3/4-14 NPTF	3.21	1.30	1.13	0.50

* Coupler has brass body and steel sleeve.



Couplers- Standard Hose Barb



Body Size	Part No. Brass	Part No. Steel	Hose I.D.	Length	Largest Diameter	Wrench Flats	Weight (lbs)
1/4	B10-3B	-	1/4	2.49	0.90	0.75	0.18
1/4	B10-4B	-	5/16	2.49	0.90	0.75	-
1/4	B10-5B	-	3/8	2.49	0.90	0.75	0.18
3/8	-	14-5B	3/8	2.60	1.06	0.88	0.26
3/8	-	14-6B	1/2	2.60	1.06	0.88	0.27
1/2	-	16-5B	3/8	3.14	1.19	1.00	0.41
1/2	-	16-6B	1/2	3.14	1.19	1.00	0.43
1/2	-	16-7B	3/4	3.60	1.19	1.00	0.48

Add suffix "N" to brass coupler part number for stainless steel springs and locking balls (ie B15N).
Add suffix "-SL" for Sleeve-Lok option.
Add suffix "R" for grip-ring sleeve (1/4" size only).

Couplers- Push-Lok Hose Barb*



Body Size	Part No. Brass	Part No. Steel	Hose I.D.	Length	Largest Diameter	Wrench Flats	Weight (lbs)
1/4	B10-3BP	-	1/4	2.32	0.90	0.75	0.19
1/4	B10-5BP	-	3/8	2.47	0.90	0.75	0.19
3/8	-	14-5BP	3/8	2.88	1.06	0.88	0.26
1/2	-	16-5BP	3/8	3.35	1.19	1.00	0.40
1/2	-	16-6BP	1/2	3.46	1.19	1.00	0.43

* Push-Lok hose barbs are designed for use with Parker Push-Lok hose and do not require clamps.



50 Series Pneumatic Couplers are interchangeable with ARO's 210 series. Couplers have brass bodies. Nipples are constructed of steel. Sleeve-Lok is an optional feature.

Features:

- Integral sleeve guard resists accidental disconnection
- Tubular valve delivers high air flow with minimal pressure drop
- Stainless steel springs and locking balls option is available for added corrosion resistance
- Standard seal is Nitrile

Applications include:

- Air compressors
- Pneumatic tools
- Water
- Grease
- Paint

Performance 50 Series (1/4" size)

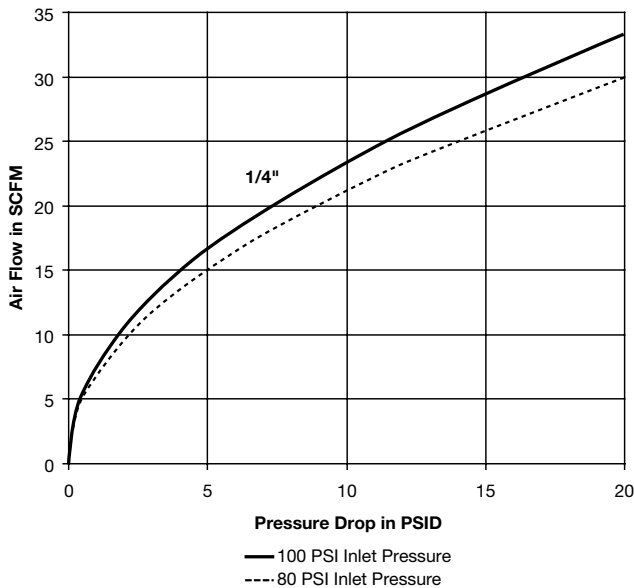

50 Series Specifications

Body Size	1/4
Rated Pressure (psi)	300
Temperature Range (std seals)	-40° to +250° F
Locking Device	4 balls
Vacuum Service	Not Recommended

Repair Kits

Body Size	Seal Material	Part No.
1/4	Nitrile	21K
1/4	Ethylene Propylene	21KW
1/4	Fluorocarbon	21KY

Optional Materials and Features:

(add code to part number)

Code	Description	Part Number Example
suffix N	Stainless steel springs, locking balls & brass valves (Couplers)	B52N
suffix -SL	Sleeve-Lok (Couplers)	B52-SL
suffix W	Ethylene Propylene seal material (-65° to + 400° F) (Couplers)	B52W
suffix Y	Fluorocarbon seal material (-30° to + 400° F) (Couplers)	B52Y

Contact QCD for availability and additional options.
To select proper seal materials, see Fluid Compatibility Chart or contact QCD.



Nipples- Female Pipe Thread



Body Size	Part No. Steel	Thread Size	Length	Largest Diameter	Exposed Length**	Wrench Flats	Weight (lbs)
1/4	A3C	1/4-18 NPTF	1.47	0.72	0.66	0.62	0.04

Nipples- Male Pipe Thread



Body Size	Part No. Steel	Thread Size	Length	Largest Diameter	Exposed Length**	Wrench Flats	Weight (lbs)
1/4	A2C	1/4-18 NPTF	1.62	0.65	0.82	0.56	0.05

Nipples- Standard Hose Barb



Body Size	Part No. Steel	Hose I.D.	Length	Largest Diameter	Exposed Length**	Wrench Flats	Weight (lbs)
1/4	A8C	1/4	1.63	.043	0.82	0.62	0.03

Nipples- Push-Lok Hose Barb*



Body Size	Part No. Steel	Hose I.D.	Length	Largest Diameter	Exposed Length**	Wrench Flats	Weight (lbs)
1/4	A8CP	1/4	1.65	.067	0.87	0.62	0.03

* Push-Lok hose barb is designed for use with Parker Push-Lok hose and do not require clamps.

**This dimension represents portion of nipple that is exposed when nipple is inserted in a Parker 50 Series coupler



Couplers- Female Pipe Thread



Body Size	Part No. Brass	Thread Size	Length	Largest Diameter	Wrench Flats	Weight (lbs)
1/4	B53	1/4-18 NPTF	1.83	0.90	0.75	0.20
1/4	B53E	3/8-18 NPTF	1.95	0.94	0.81	0.21

Couplers- Male Pipe Thread



Body Size	Part No. Brass	Thread Size	Length	Largest Diameter	Wrench Flats	Weight (lbs)
1/4	B52	1/4-18 NPTF	2.05	0.90	0.75	0.20
1/4	B52E	3/8-18 NPTF	2.08	0.90	0.75	0.21

Couplers- Push-Lok Hose Barb*



Body Size	Part No. Brass	Hose I.D.	Length	Largest Diameter	Wrench Flats	Weight (lbs)
1/4	B50-3BP	1/4	2.32	0.90	0.75	0.19
1/4	B50-5BP	3/8	2.47	0.90	0.75	0.20

* Push-Lok hose barbs are designed for use with Parker Push-Lok hose and do not require clamps.

Pneumatic Quick Couplings

General Purpose

HA Series Couplers

ARO 210 Interchange

Push-to-connect sleeve, single shut off



HA Series Pneumatic Couplers are interchangeable with ARO's 210 series and also connect with Parker's 50 Series nipples. Couplers have brass bodies and steel valves. Nipples are constructed of steel. Sleeve-Lok is an optional feature

Features

- Integral sleeve guard resists accidental disconnection
- Push-to-connect sleeve for easy one hand operation
- Tubular valve delivers high air flow with minimal pressure drop
- Standard seal is Nitrile

Applications:

- Air compressors
- Pneumatic tools
- Water
- Grease
- Paint

Performance

HA Series (1/4" size)

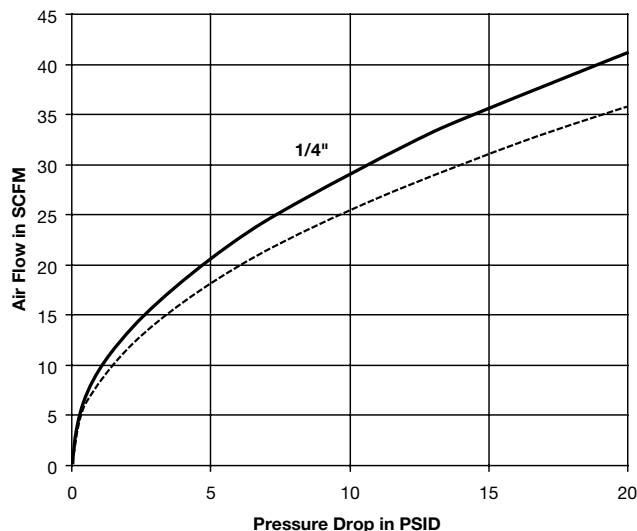

HA Series Specifications	
Body Size	1/4
Rated Pressure (psi)	300
Temperature Range (std seals)	-40° to +250° F
Locking Device	4 balls
Vacuum Service	Not Recommended

How To Order

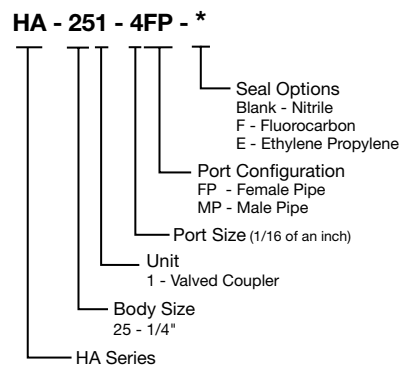

Note: See 50 Series for mating Nipples.

Repair Kits		
Body Size	Seal Material	Part No.
1/4	Nitrile	21K
1/4	Ethylene Propylene	21KW
1/4	Fluorocarbon	21KY

Optional Seal Materials:

(add code to part number)

Code	Description	Part Number Example
suffix W	Ethylene Propylene seal material (-65° to + 400° F) (Couplers)	HA-251-4FPW
suffix Y	Fluorocarbon seal material (-30° to + 400° F) (Couplers)	HA-251-4FPY

Contact QCD for availability and additional options.
To select proper seal materials, see Fluid Compatibility Chart or contact QCD.





Couplers- Female Pipe Thread



Body Size	Part No. Brass	Thread Size	Length	Largest Diameter	Wrench Flats	Weight (lbs)
1/4	HA-251-4FP	1/4-18 NPSF	2.11	1.01	081	0.26

Couplers- Male Pipe Thread



Body Size	Part No. Brass	Thread Size	Length	Largest Diameter	Wrench Flats	Weight (lbs)
1/4	HA-251-4MP	1/4-18 NPSF	2.26	1.01	0.81	0.24

Note: See 50 Series for mating Nipples.

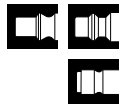

UC Series Pneumatic Quick Couplers connect with Industrial Interchange, 10 series (Tru-Flate), and 50 series (ARO 210) style nipples. While the best performance is obtained by matching like series couplers and nipples, the Universal Coupler permits multiple series nipples to mate with one coupler.

Features:

- Sleeve guard protects against accidental disconnection
- Push-to-connect operation
- Brass construction
- One coupler connects with three nipple styles

Applications include:

- Air compressors
- Pneumatic tools
- Drop-down air lines

Performance

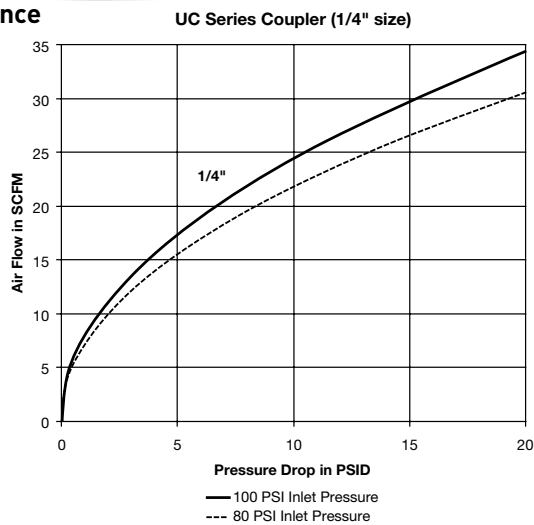

UC Series Specifications

Body Size	Rated Pressure (psi)	Temperature Range (Nitrile seals)	Locking Device	Vacuum Service
1/4	150	-40° to +250° F	4 balls	Not Recommended

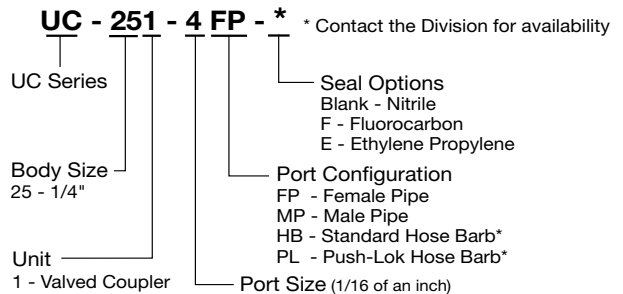

Couplers - Female Pipe Thread



Body Size	Part No. Brass	Thread Size	Length	Largest Diameter	Wrench Flats	Weight (lbs.)
1/4	UC-251-4FP	1/4-18 NPSF	2.06	0.98	0.81	0.23
1/4	UC-251-6FP	3/8-18 NPSF	2.21	0.98	0.81	0.23

Couplers - Male Pipe Thread



Body Size	Part No. Brass	Thread Size	Length	Largest Diameter	Wrench Flats	Weight (lbs.)
1/4	UC-251-4MP	1/4-18 NPTF	2.21	0.98	0.81	0.22
1/4	UC-251-6MP	3/8-18 NPTF	2.24	0.98	0.81	0.23



70 Series Pneumatic Couplers are interchangeable with Lincoln's "Long Stem" series couplings. Couplers have brass bodies and steel valves. Nipples are constructed of steel. Sleeve-Lok is an optional feature.

Features

- Integral sleeve guard resists accidental disconnection
- Tubular valve delivers high air flow with minimal pressure drop
- Standard seal is Nitrile

Applications:

- Air compressors
- Pneumatic tools
- Water
- Grease
- Paint

Performance 70 Series (1/4" size)

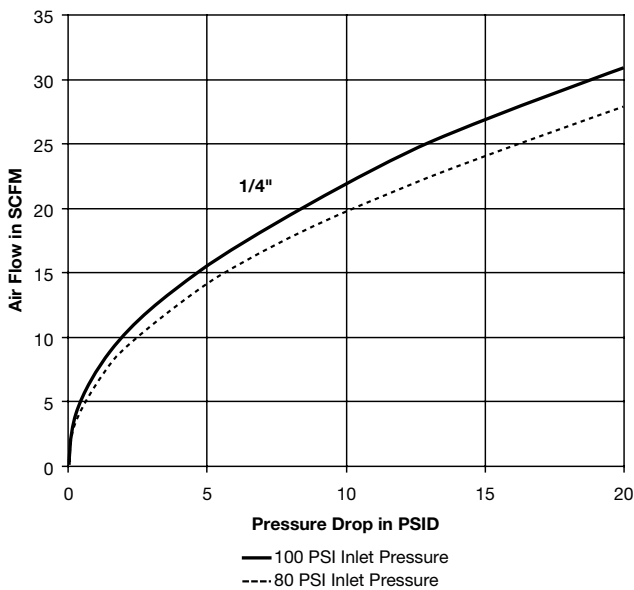

70 Series Specifications	
Body Size	1/4
Rated Pressure (psi)	300
Temperature Range (std seals)	-40° to +250° F
Locking Device	4 balls
Vacuum Service	Not Recommended

Repair Kits		
Body Size	Seal Material	Part No.
1/4	Nitrile	21K
1/4	Ethylene Propylene	21KW
1/4	Fluorocarbon	21KY

Couplers - Female Pipe Thread



Body Size	Part No. Brass	Thread Size	Length	Largest Diameter	Wrench Flats	Weight (lbs.)
1/4	B73	1/4-18 NPTF	2.40	0.90	0.75	0.25



Couplers - Male Pipe Thread



Body Size	Part No. Brass	Thread Size	Length	Largest Diameter	Wrench Flats	Weight (lbs.)
1/4	B72	1/4-18 NPTF	2.62	0.90	0.75	0.25

Nipples - Female Pipe Thread



Body Size	Part No. Steel	Thread Size	Length	Exposed Length*	Largest Diameter	Wrench Flats	Weight (lbs.)
1/4	L3C	1/4-18 NPTF	2.10	0.77	0.65	0.56	0.05

Nipples - Male Pipe Thread



Body Size	Part No. Steel	Thread Size	Length	Exposed Length*	Largest Diameter	Wrench Flats	Weight (lbs.)
1/4	L2C	1/4-18 NPTF	2.25	0.92	0.65	0.56	0.06

* This dimension represents portion of nipple that is exposed when nipple is inserted in a Parker 70 Series coupler.

Optional Materials and Features:

(add code to part number)

Code	Description	Part Number Example
suffix N	Stainless steel springs, locking balls & brass valves (Couplers)	B72N
suffix -SL	Sleeve-Lok (Couplers)	B72-SL
suffix W	Ethylene Propylene seal material (-65° to + 400° F) (Couplers)	B72W
suffix Y	Fluorocarbon seal material (-30° to + 400° F) (Couplers)	B72Y

Contact QCD for availability and additional options.

To select proper seal materials, see Fluid Compatibility Chart or contact QCD.



RF Series Pneumatic Couplers are designed to increase flow and reduce pressure drop through the coupling. RF nipples have up to 2-1/2 times larger flow area than standard industrial interchange nipples. The increased flow results in greater tool efficiency and decreased air costs. Couplers have brass bodies with nickel plated steel sleeves. RF nipples are steel.

Features:

- Aerodynamic valve design
- Steel nipples are case hardened
- Flow rates on 1/4" is greater than many 3/8" body size couplers
- Flow rates on 3/8" is greater than many 1/2" body size couplers
- Integral sleeve guard protects against accidental disconnection
- Functionally interchanges with a common high-flow European design. 1/4 RF interchanges with Rectus 25 and CEJN 320. 3/8" RF interchanges with Rectus 27 and CEJN 410
- Standard seal is Nitrile

Applications include:

- Air compressors
- Pneumatic tools
- Drop-down air lines

How To Order

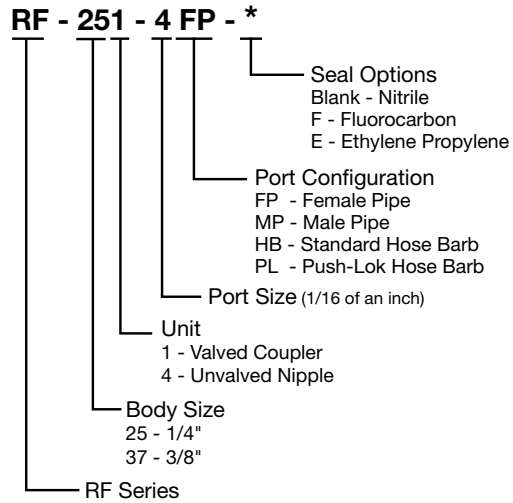

Performance RF Series (1/4" & 3/8" body size) with 1/4" & 3/8" Female NPSF

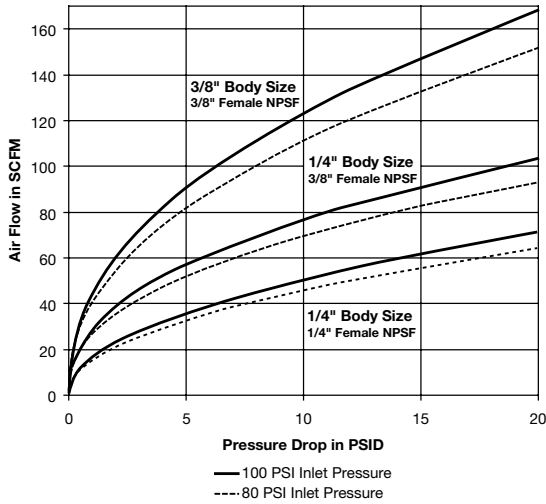

RF Series Specifications		
Body Size	1/4	3/8
Rated Pressure (psi)	300	
Temperature Range (std seals)	-40° to +250° F	
Locking Device	4 balls	8 balls
Vacuum Service	Not Recommended	

Optional Seal Materials:

(add code to part number)

Code	Description	Part Number Example
suffix W	Ethylene Propylene seal material (-65° to +400° F) [Couplers]	RF-251-4FPW
suffix Y	Fluorocarbon seal material (-30° to +400° F) [Couplers]	RF-251-4FPY

Contact QCD for availability and additional options.
To select proper seal materials, see Fluid Compatibility Chart or contact QCD.



Couplers- Female Pipe Thread



Body Size	Part No. Brass	Thread Size	Length	Largest Diameter	Wrench Flats	Weight (lbs.)
1/4	RF-251-4FP	1/4-18 NPSF	2.19	0.99	0.81	0.26
1/4	RF-251-6FP	3/8-18 NPSF	2.34	0.99	0.81	0.27
3/8	RF-371-6FP	3/8-18 NPSF	2.33	1.07	0.94	0.31
3/8	RF-371-8FP	1/2-14 NPTF	2.49	1.07	1.00	0.35

Couplers- Male Pipe Thread



Body Size	Part No. Brass	Thread Size	Length	Largest Diameter	Wrench Flats	Weight (lbs.)
1/4	RF-251-4MP	1/4-18 NPTF	2.34	0.99	0.81	0.24
1/4	RF-251-6MP	3/8-18 NPTF	2.37	0.99	0.81	0.25
1/4	RF-251-8MP	1/2-14 NPTF	2.56	0.99	0.88	0.29
3/8	RF-371-6MP	3/8-18 NPTF	2.52	1.07	0.94	0.30
3/8	RF-371-8MP	1/2-14 NPTF	2.68	1.07	0.94	0.33

Couplers- Standard Hose Barb



Body Size	Part No. Brass	Hose I.D.	Length	Largest Diameter	Wrench Flats	Weight (lbs.)
1/4	RF-251-4HB	1/4	2.81	0.99	0.81	0.26
1/4	RF-251-6HB	3/8	2.81	0.99	0.81	0.27
3/8	RF-371-6HB	3/8	3.02	1.07	0.94	0.31
3/8	RF-371-8HB	1/2	3.02	1.07	0.94	0.34

Couplers- Push-Lok Hose Barb*



Body Size	Part No. Brass	Hose I.D.	Length	Largest Diameter	Wrench Flats	Weight (lbs.)
1/4	RF-251-4PL	1/4	2.64	0.99	0.81	0.26
1/4	RF-251-6PL	3/8	2.78	0.99	0.81	0.27
1/4	RF-251-8PL	1/2	2.93	0.99	0.81	0.28
3/8	RF-371-6PL	3/8	3.02	1.07	0.94	0.33
3/8	RF-371-8PL	1/2	3.02	1.07	0.94	0.33

* Push-Lok hose barbs are designed for use with Parker Push-Lok hose and do not require clamps.



Nipples- Female Pipe Thread



Body Size	Part No. Steel	Thread Size	Length	Largest Diameter	Wrench Flats	Weight (lbs.)
1/4	RF-254-4FP	1/4-18 NPTF	1.45	0.72	0.62	0.06
1/4	RF-254-6FP	3/8-18 NPTF	1.50	0.94	0.81	0.09
3/8	RF-374-6FP	3/8-18 NPTF	1.53	0.94	0.81	0.10
3/8	RF-374-8FP	1/2-14 NPTF	1.62	1.16	1.00	0.13

Nipples- Male Pipe Thread



Body Size	Part No. Steel	Thread Size	Length	Largest Diameter	Wrench Flats	Weight (lbs.)
1/4	RF-254-4MP	1/4-18 NPTF	1.60	0.65	0.56	0.05
1/4	RF-254-6MP	3/8-18 NPTF	1.67	0.75	0.69	0.08
1/4	RF-374-6MP	3/8-18 NPTF	1.70	0.75	0.69	0.09
3/8	RF-374-8MP	1/2-14 NPTF	1.85	1.01	0.88	0.15

Nipples- Standard Hose Barb



Body Size	Part No. Steel	Hose I.D.	Length	Largest Diameter	Weight (lbs.)
1/4	RF-254-4HB	1/4	1.66	0.50	0.04
1/4	RF-254-6HB	3/8	1.66	0.50	0.05
3/8	RF-374-6HB	3/8	1.63	0.59	0.07
3/8	RF-374-8HB	1/2	1.87	0.68	0.08

Nipples- Push-Lok Hose Barb*



Body Size	Part No. Steel	Hose I.D.	Length	Largest Diameter	Weight (lbs.)
1/4	RF-254-4PL	1/4	1.69	0.50	0.04
1/4	RF-254-6PL	3/8	1.83	0.50	0.05
3/8	RF-374-6PL	3/8	1.80	0.59	0.07
3/8	RF-374-8PL	1/2	2.09	0.897	0.09

* Push-Lok hose barbs are designed for use with Parker Push-Lok hose and do not require clamps.

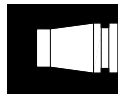

TL Series Pneumatic Couplers are interchangeable with Schraders Twist-Lock style couplings. Couplers have brass bodies and steel sleeves. Nipples are constructed of steel.

Features:

- Designed to resist accidental disconnection
- Push-to-connect, twist sleeve 1/8 turn to disconnect
- Tubular valve delivers high air flow with minimal pressure drop
- Standard seal is Nitrile

Applications include:

- Air compressors
- Pneumatic tools
- Water
- Grease
- Paint

Performance

Twist-Lock Series (1/4" size)

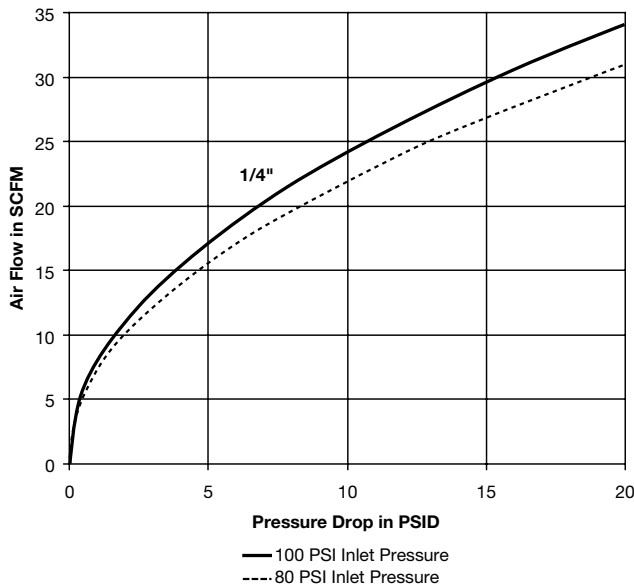

TL Series Specifications

Body Size	1/4	1/2
Rated Pressure (psi)	300	
Temperature Range (std seals)	-40° to +250° F	
Locking Device	CAM	
Vacuum Service	Not recommended	

How To Order

TL - 25 1 - 4 FP

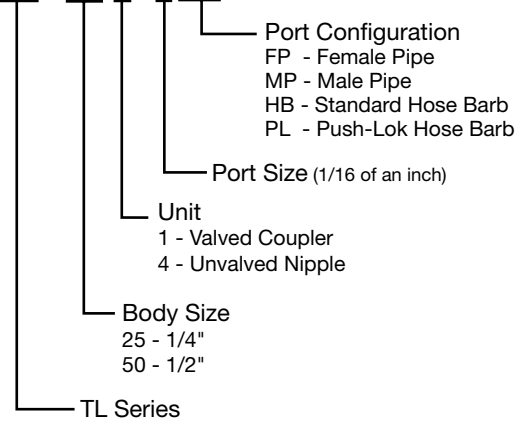

Repair Kits

Body Size	Seal Material	Part No.
1/4	Nitrile	21K
1/4	Ethylene Propylene	21KW
1/4	Fluorocarbon	21KY
1/2	Nitrile	16K
1/2	Ethylene Propylene	16KW
1/2	Fluorocarbon	16KY



Couplers- Female Thread



Body Size	Part No.	Thread Size	Length	Largest Diameter	Wrench Flats	Weight (lbs)
1/4	TL-251-4FP	1/4-18 NPTF	2.01	1.12	0.75	0.21
1/2	TL-501-6FP	3/8-18 NPTF	2.55	1.50	1.13	0.44
1/2	TL-501-8FP	1/2-14 NPTF	2.78	1.50	1.13	0.44
1/2	TL-501-12FP	3/4-14 NPTF	2.91	1.50	1.13	0.44

Couplers- Male Thread



Body Size	Part No.	Thread Size	Length	Largest Diameter	Wrench Flats	Weight (lbs)
1/4	TL-251-4MP	1/4-18 NPTF	2.23	1.12	0.75	0.21
1/4	TL-251-6MP	3/8-18 NPTF	2.26	1.12	0.75	0.22
1/2	TL-501-6MP	3/8-18 NPTF	2.71	1.50	1.13	0.39
1/2	TL-501-8MP	1/2-14 NPTF	2.88	1.50	1.13	0.40

Optional Seal Materials:
(add code to part number)

Code	Description	Part Number Example
suffix W	Ethylene Propylene seal material (-65° to + 400° F) (Couplers)	TL-251-4FPW
suffix Y	Fluorocarbon seal material (-30° to + 400° F) (Couplers)	TL-251-4FPY

Contact QCD for availability and additional options.
To select proper seal materials, see Fluid Compatibility Chart or contact QCD.

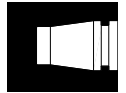

Nipples- Female Thread



Body Size	Part No.	Thread Size	Length	Largest Diameter	Wrench Flats	Weight (lbs)
1/4	TL-254-2FP	1/8-27 NPTF	1.50	0.58	0.50	0.04
1/4	TL-254-4FP	1/4-18 NPTF	1.60	0.72	0.63	0.06
1/2	TL-504-4FP	1/4-18 NPTF	1.90	0.80	0.69	0.12
1/2	TL-504-6FP	3/8-18 NPTF	1.75	0.94	0.81	0.13

Nipples- Male Thread



Body Size	Part No.	Thread Size	Length	Largest Diameter	Wrench Flats	Weight (lbs)
1/4	TL-254-2MP	1/8-27 NPTF	1.68	0.58	0.50	0.05
1/4	TL-254-4MP	1/4-18 NPTF	1.72	0.65	0.56	0.06
1/2	TL-504-4MP	1/4-18 NPTF	1.90	0.80	0.69	0.12
1/2	TL-504-6MP	3/8-18 NPTF	1.90	0.80	0.69	0.12
1/2	TL-504-8MP	1/2-14 NPTF	2.06	1.01	0.88	0.16
1/2	TL-504-12MP	3/4-14 NPTF	2.12	1.22	1.06	0.22

Nipples- Standard Hose Barb



Body Size	Part No.	Hose I.D.	Length	Largest Diameter	Weight (lbs)
1/4	TL-254-4HB	1/4	1.83	0.50	0.03
1/4	TL-254-6HB	3/8	1.83	0.50	0.04
1/2	TL-504-4HB	1/4	2.06	0.67	0.07
1/2	TL-504-6HB	3/8	2.06	0.67	0.08
1/2	TL-504-8HB	1/2	2.06	0.67	0.10

Pneumatic Quick Couplings

General Purpose

IH Series

Snap-tite Design

Manual Sleeve, Single Shut-off



A Pneumatics



IH couplers are steel with a cylindrical valve designed specifically for pneumatic use. When paired with an unvalved/plain H Series nipple, it functions as a durable single shut-off connection. Standard seal is nitrile.

Features:

- Sizes 1/4" - 3/4"
- Steel body material
- Standard seal material is nitrile with other options available
- Optional sleeve lock helps to prevent accidental disconnection
- Manually operated sleeve provides secure connection
- Coupler has 360° cylindrical valve contact

Applications include:

- Industrial air lines
- Pneumatic tools

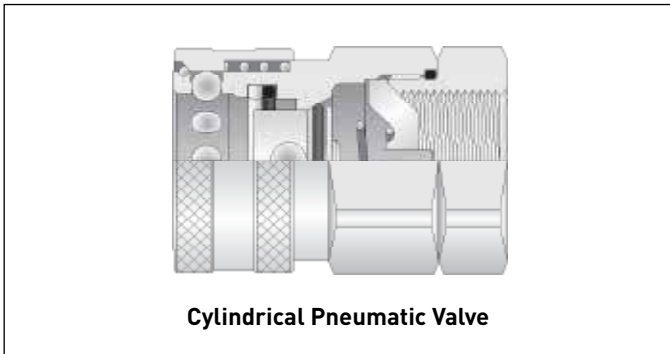

IH Series Working Pressures (psi)				
Valved on coupler and unvalved nipple (Single Shut-off)				
Body Size	1/4	3/8	1/2	3/4
Steel	6500	4500	4000	3500

NOTE: Pressure ratings were established under static pressure conditions. Therefore, pressure ratings for any given flow, pressure surge and/or vibration may vary from these ratings. Burst pressures listed were taken at the point at which failure rendered the quick disconnect inoperative. (Proof pressure equals 1-1/2 times the working pressure; burst pressure equals 2 times working pressure.)

Performance

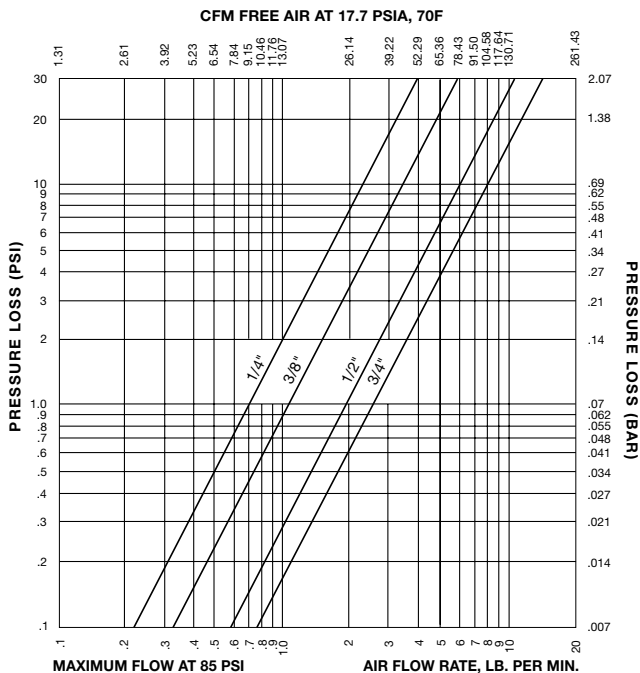



IH Series Couplers



Body Size	Part No. Steel	Thread Size	Length	Largest Diameter	Wrench Flats	Sleeve Lock
1/4	VIHC4-4F	1/4 -18 NPTF (female)	1.65	1.19	1.00	
1/4	VIHC4-4FSL	1/4 -18 NPTF (female)	1.65	1.19	1.00	Y
1/4	VIHC4-4M	1/4 -18 NPT (male)	2.09	1.02	0.88	
1/4	VIHC4-4MSL	1/4 -18 NPT (male)	2.09	1.02	0.88	Y
3/8	VIHC6-6F	3/8 -18 NPTF (female)	1.90	1.19	1.00	
3/8	VIHC6-6FSL	3/8 -18 NPTF (female)	1.90	1.19	1.00	Y
3/8	VIHC6-6M	3/8 -18 NPT (male)	2.19	1.19	1.00	
3/8	VIHC6-6MSL	3/8 -18 NPT (male)	2.19	1.19	1.00	Y
1/2	VIHC8-8F	1/2 -14 NPTF (female)	2.09	1.39	1.19	
3/4	VIHC12-12F	3/4 -14 NPTF (female)	2.42	1.73	1.50	

H Series Nipples - Unvalved / Plain



Body Size	Part No. Steel	Thread Size	Length	Largest Diameter	Wrench Flats
1/4	HN4-4F	1/4 -18 NPTF (female)	1.32	0.73	0.88
1/4	HN4-4M	1/4 -18 NPT (male)	0.78	0.65	0.56
3/8	HN6-6F	3/8 -18 NPTF (female)	1.52	0.94	0.81
3/8	HN6-6M	3/8 -18 NPT (male)	0.98	0.80	0.69
1/2	HN8-8F	1/2 -14 NPTF (female)	1.72	1.15	1.00
1/2	HN8-8M	1/2 -14 NPTF (male)	1.01	1.02	0.88
3/4	HN12-12F	3/4 -14 NPT (female)	1.92	1.37	1.19
3/4	HN12-12M	3/4 -14 NPT (male)	1.14	1.22	1.06

Pneumatic Quick Couplings Special Purpose

Tool-Mate Series Couplers (Standard) RF and Industrial Interchange Styles

Non-marring, push-to-connect sleeve



A Pneumatics



Tool-Mate Series are light weight and easy to operate with a non-marring body. Couplers are constructed of Polyamide material with galvanized steel port ends. Springs, balls and pins are stainless steel and locking fingers are polyacetate. Grey body color designates standard, non-venting style coupler.

Features:

- Push-to-connect operation, pull sleeve in the direction of the arrow to release the nipple
- PBH part number (yellow ring) couplers connect with Industrial Interchange nipples
- PER part number (green ring) couplers connect with RF series nipples
- Standard seal is Nitrile

Applications include:

- Pneumatic tools
- Drop-down air lines

Performance

Tool-Mate Series Standard (1/4" & 3/8" sizes)

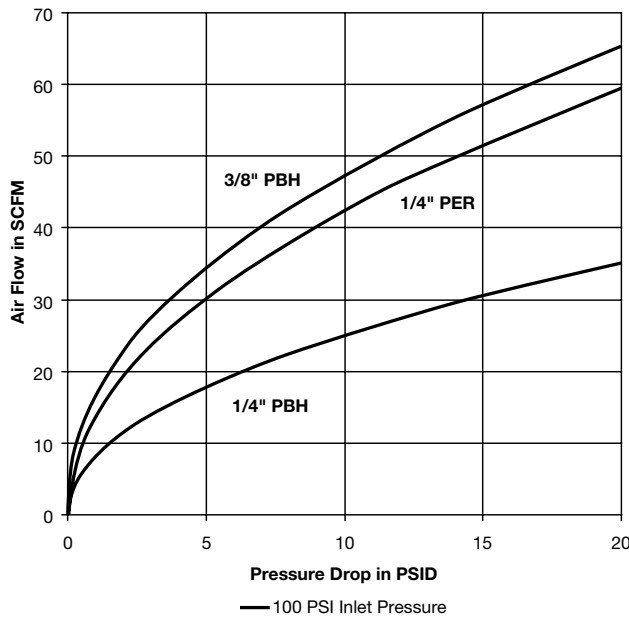

Tool Mate Standard Series Specifications		
Body Size	1/4	3/8
Rated Pressure (psi)	300	
Temperature Range	0 to 160° F	
Vacuum Service	Not recommended	

How To Order

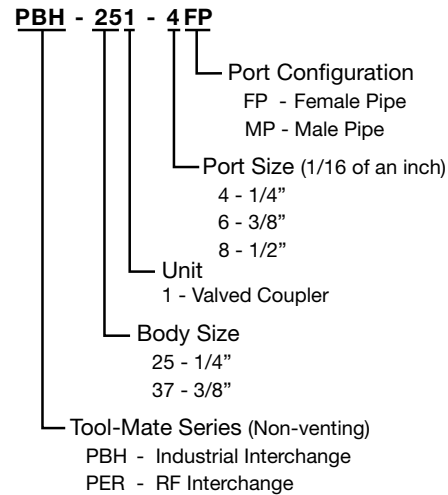



Industrial Interchange-Female Pipe Thread



Body Size	Part No.	Thread Size	Length	Largest Diameter	Wrench Flats	Weight (lbs)
1/4	PBH-251-4FP	1/4-18 NPTF	2.60	1.19	0.67	0.13
1/4	PBH-251-6FP	3/8-18 NPTF	2.67	1.19	0.91	0.15
3/8	PBH-371-4FP	1/4-18 NPTF	2.95	1.38	0.67	0.21
3/8	PBH-371-6FP	3/8-18 NPTF	2.95	1.38	0.83	0.20
3/8	PBH-371-8FP	1/2-14 NPTF	3.17	1.38	0.99	0.22

Industrial Interchange-Male Pipe Thread



Body Size	Part No.	Thread Size	Length	Largest Diameter	Wrench Flats	Weight (lbs)
1/4	PBH-251-4MP	1/4-18 NPTF	2.97	1.19	0.67	0.14
1/4	PBH-251-6MP	3/8-18 NPTF	2.99	1.19	0.91	0.19
3/8	PBH-371-4MP	1/4-18 NPTF	3.39	1.38	0.83	0.23
3/8	PBH-371-6MP	3/8-18 NPTF	3.39	1.38	0.83	0.23

RF Interchange-Female Pipe Thread



Body Size	Part No.	Thread Size	Length	Largest Diameter	Wrench Flats	Weight (lbs)
1/4	PER-251-4FP	1/4-18 NPTF	2.83	1.25	0.83	0.17
1/4	PER-251-6FP	3/8-18 NPTF	2.83	1.25	0.83	0.15

RF Interchange-Male Pipe Thread



Body Size	Part No.	Thread Size	Length	Largest Diameter	Wrench Flats	Weight (lbs)
1/4	PER-251-4MP	1/4-18 NPTF	2.36	1.25	0.83	0.19
1/4	PER-251-6MP	3/8-18 NPTF	2.40	1.25	0.83	0.18

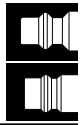

Tool-Mate Series are light weight and easy to operate with a non-marring body. Exhaust style couplers allow disconnection at zero pressure to avoid dangerous hose whip. Couplers are constructed of Polyamide material with galvanized steel port ends. Springs, balls and pins are stainless steel and locking fingers are polyacetate. Black body color designates venting, exhaust style coupler.

Features:

- Meets ISO 4414 requirements for a controlled pressure release system
- Push-to-connect operation, two step disconnection as indicated by the arrows, provides safe venting of downstream pressure
- PBS part number (yellow ring) couplers connect with Industrial Interchange nipples
- PES part number (green ring) couplers connect with RF series nipples
- Standard seal is Nitrile

Applications include:

- Pneumatic tools
- Drop-down air lines

Performance

Tool-Mate Series Exhaust (1/4", 3/8" & 1/2" sizes)

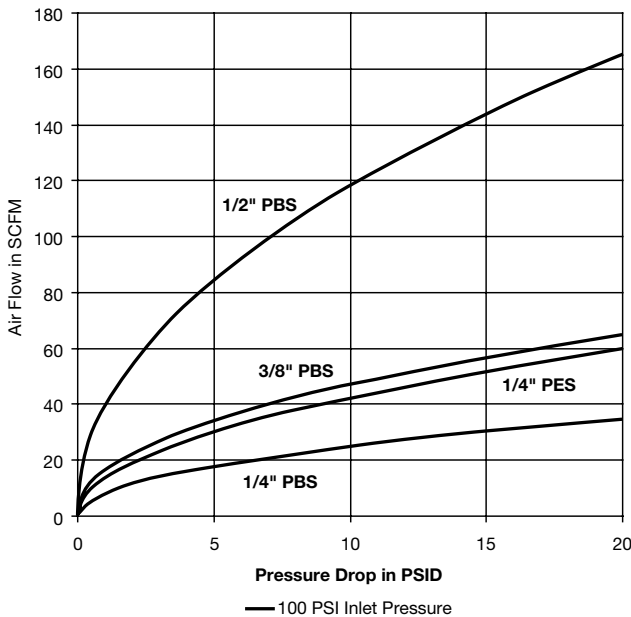

Tool Mate Exhaust Series Specifications

Body Size	1/4	3/8	1/2
Rated Pressure (psi)	300		
Temperature Range	0 to 160° F		
Vacuum Service	Not recommended		

How To Order

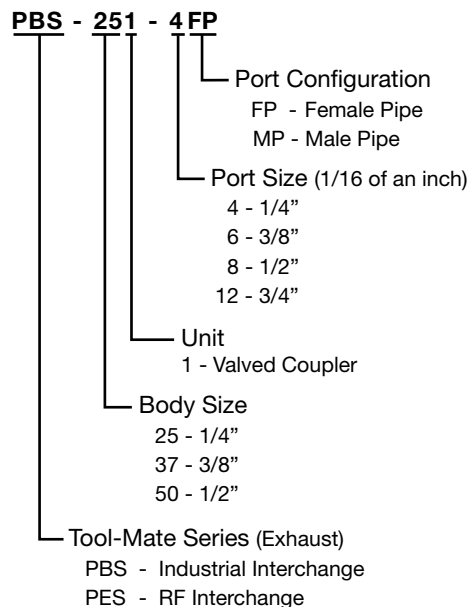



Exhaust Industrial Interchange- Female Pipe Thread



Body Size	Part No.	Thread Size	Length	Largest Diameter	Wrench Flats	Weight (lbs)
1/4	PBS-251-4FP	1/4-18 NPTF	2.60	1.19	0.67	0.13
1/4	PBS-251-6FP	3/8-18 NPTF	2.67	1.19	0.91	0.15
3/8	PBS-371-6FP	3/8-18 NPTF	2.95	1.38	0.82	0.20
3/8	PBS-371-8FP	1/2-14 NPTF	3.17	1.38	0.99	0.22
1/2	PBS-501-6FP	3/8-18 NPTF	3.25	1.62	1.18	0.50
1/2	PBS-501-8FP	1/2-14 NPTF	3.36	1.62	1.18	0.50
1/2	PBS-501-12FP	3/4-14 NPTF	3.66	1.62	1.18	0.50

Exhaust Industrial Interchange-Male Pipe Thread



Body Size	Part No.	Thread Size	Length	Largest Diameter	Wrench Flats	Weight (lbs)
1/4	PBS-251-4MP	1/4-18 NPTF	2.97	1.19	0.67	0.14
1/4	PBS-251-6MP	3/8-18 NPTF	2.99	1.19	0.91	0.19
3/8	PBS-371-6MP	3/8-18 NPTF	3.39	1.38	0.82	0.23
3/8	PBS-371-8MP	1/2-14 NPTF	3.39	1.38	0.91	0.28
1/2	PBS-501-8MP	1/2-14 NPTF	3.70	1.62	1.18	0.50

Exhaust RF Interchange-Female Pipe Thread



Body Size	Part No.	Thread Size	Length	Largest Diameter	Wrench Flats	Weight (lbs)
1/4	PES-251-6FP	3/8-18 NPTF	2.83	0.83	0.83	0.15

Exhaust RF Interchange-Male Pipe Thread



Body Size	Part No.	Thread Size	Length	Largest Diameter	Wrench Flats	Weight (lbs)
1/4	PES-251-4MP	1/4-18 NPTF	2.36	1.25	0.83	0.19

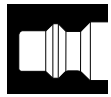

E-z-mate Series are exhaust type quick couplers that are designed to safely relieve air pressure prior to disconnection. When the valve sleeve is twisted to shut off air flow, it automatically vents downstream allowing for disconnection at zero pressure and eliminating the risk of "hose whip".

Features:

- Self-locking valve sleeve protects against accidental disconnection
- Push-to-connect operation
- Meets ISO 4414 requirements for a controlled pressure release system
- Connection and disconnection at zero pressure
- Brass material option - contact QCD for availability

Applications include:

- Pneumatic tools
- Drop-down air lines

Operation

Parker E-z-mate couplings combine push-to-connect, exhaust-style action with a self-locking valve sleeve to guard against accidental disconnection. Simply follow the direction of the On-Off arrow stamped on the valve sleeve. It's that easy.

To connect, push the nipple into the coupler. The black locking sleeve automatically slides forward securely locking the nipple in place. No air is allowed to flow through the coupling at this point. The valve sleeve is then rotated clockwise (when viewed from the coupler port end) to open flow and automatically engage the sleeve-lock mechanism.

To disconnect, rotate the valve sleeve counter clockwise (when viewed from the coupler end). The flow of air through the coupling will be shut off and all downstream air is vented to the atmosphere. The locking sleeve may now be retracted and the nipple removed. Lubricate sleeve as part of periodic maintenance to coupler.

Performance

E-z-mate Series (1/4" & 3/8" sizes)

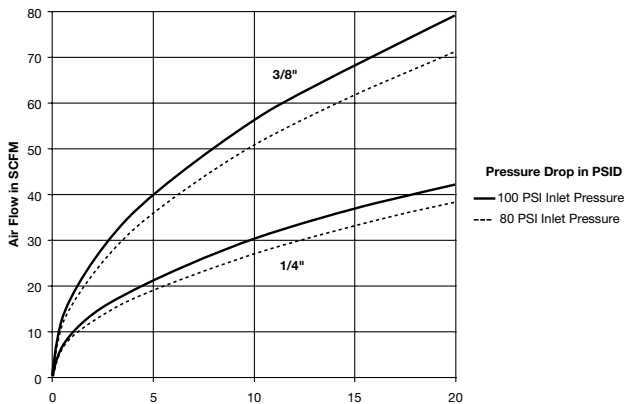

E-z-mate Series (1/2" & 3/4" sizes)

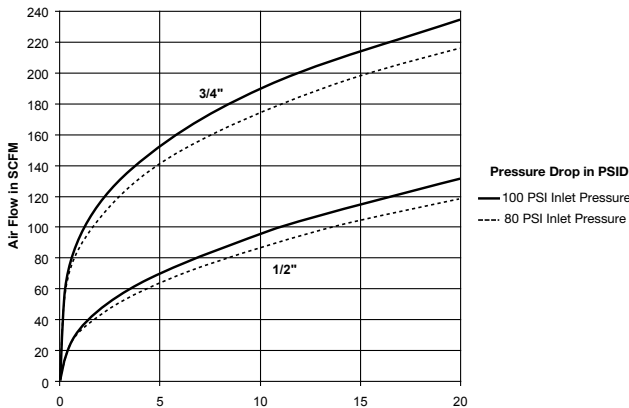

E-z-mate Series Specifications

Body Size	1/4	3/8	1/2	3/4
Rated Pressure (psi)	300			
Temperature Range (std seals)	-40° to +250° F			
Locking Device	4 balls	4 balls	6 balls	8 balls
Force required to connect (lbs.)	Less than 10			
Vacuum Service	Not Recommended			

EZ - 251 - 4 FP

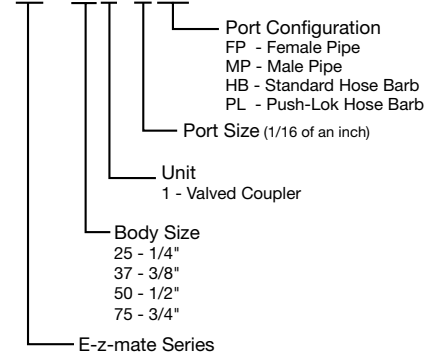



Couplers-Female Pipe Thread



Body Size	Part No.	Thread Size	Length	Largest Diameter	Wrench Flats	Weight (lbs)
1/4	EZ-251-4FP	1/4-18 NPTF	2.25	1.00	0.75	0.25
1/4	EZ-251-6FP	3/8-18 NPTF	2.68	1.01	0.88	0.29
3/8	EZ-371-6FP	3/8-18 NPTF	2.53	1.18	0.88	0.38
3/8	EZ-371-8FP	1/2-14 NPTF	3.00	1.30	1.12	0.50
1/2	EZ-501-8FP	1/2-14 NPTF	3.01	1.38	1.12	0.65
1/2	EZ-501-12FP	3/4-14 NPTF	3.44	1.59	1.38	0.70
3/4	EZ-751-12FP	3/4-14 NPTF	3.01	1.57	1.38	0.76
3/4	EZ-751-16FP	1-11 1/2 NPTF	3.52	1.80	1.56	0.92

Couplers-Male Pipe Thread



Body Size	Part No.	Thread Size	Length	Largest Diameter	Wrench Flats	Weight (lbs)
1/4	EZ-251-4MP	1/4-18 NPTF	2.85	1.00	0.75	0.30
1/4	EZ-251-6MP	3/8-18 NPTF	2.87	1.00	0.75	0.31
3/8	EZ-371-6MP	3/8-18 NPTF	3.10	1.18	0.88	0.44
1/2	EZ-501-8MP	1/2-14 NPTF	3.62	1.38	1.12	0.73
3/4	EZ-751-12MP	3/4-14 NPTF	4.04	1.57	1.38	0.90

Couplers-Standard Hose Barb



Body Size	Part No.	Hose I.D.	Length	Largest Diameter	Wrench Flats	Weight (lbs)
1/4	EZ-251-4HB	1/4	3.20	1.00	0.75	0.28
1/4	EZ-251-6HB	3/8	3.20	1.00	0.75	0.29
3/8	EZ-371-6HB	3/8	3.43	1.18	0.88	0.42
1/2	EZ-501-8HB	1/2	4.06	1.40	1.12	0.70

Couplers-Push-Lok Hose Barb*



Body Size	Part No.	Hose I.D.	Length	Largest Diameter	Wrench Flats	Weight (lbs)
1/4	EZ-251-4PL	1/4	3.03	1.00	0.75	0.28
1/4	EZ-251-6PL	3/8	3.18	1.00	0.75	0.29
3/8	EZ-371-6PL	3/8	3.38	1.18	0.88	0.42
1/2	EZ-501-8PL	1/2	3.91	1.38	1.12	0.70

* Push-Lok hose barbs are designed for use with Parker Push-Lok hose and do not require clamps.



GF/GF-1 Series couplings are valved on the coupler half and will automatically shut off gas flow when coupling is disconnected and automatically open on connection. They also incorporate a safety fuse in the nipple that will shut off the gas supply to your application in the event temperatures exceed 350°F.

Features:

- Superior flow capacity
- 1/2 psi max pressure rating
- 1/4" - 1-1/4" size range
- Certified to ANSI Z21-41-2011, CSA 6.9-2011 for use with natural, manufactured and mixed gases, liquefied petroleum gases and LP gas-air mixtures
- Fusible link internal to the nipple protects against gas-fed fires

Applications include:

- Small Gas Appliances



GF Specifications

Body Size	1/4	3/8	1/2	3/4	1	1-1/4
Flow Capacity*	24,300 Btu/hr	50,000 Btu/hr	99,600 Btu/hr	212,000 Btu/hr	378,000 Btu/hr	475,000 Btu/hr
Temperature Range: Standard GF/GF-1 (indoor use) temperature range: 32°F to 200°F. Contact QCD for low temperature version (outdoor use) temperature range: -40°F to 200°F						

*Based on a 1000 Btu per cubic foot gas with a specific gravity of 0.64 at a pressure drop of 0.3 in. w.c.

Couplers



Body Size	Part Number Brass	Port End	Length	Connected Length	Largest Diameter	Wrench Flats	Weight (lbs)
1/4	BVGFC4-4F	1/4-18 NPTF	1.64	2.41	0.96	0.88	0.194
3/8	BVGFC6-6F	3/8-18 NPTF	1.90	2.69	1.22	1.00	0.284
1/2	BVGF-1C8-8F	1/2-14 NPTF	2.47	3.39	1.42	1.00	0.326
3/4	BVGF-1C12-12F	3/4-14 NPTF	2.51	3.48	1.66	1.31	0.534
1	BVGFC16-16F	1-11-1/2 NPTF	2.69	3.91	2.03	1.88	1.150
1-1/4	BVGFC20-20F	1-1/4-11-1/2 NPTF	3.54	4.88	2.25	2.00	1.568

Nipples



Body Size	Part Number Brass	Port End	Length	Connected Length	Largest Diameter	Wrench Flats	Weight (lbs)
1/4	BPGFN4-4F	1/4-18 NPTF	1.32	2.41	0.69	0.62	0.052
3/8	BPGFN6-6F	3/8-18 NPTF	1.52	2.69	0.91	0.81	0.105
1/2	BPGF-1N8-8F	1/2-14 NPTF	1.55	3.39	1.13	1.00	0.154
3/4	BPGF-1N12-12F	3/4-14 NPTF	1.79	3.48	1.34	1.19	0.212
1	BPGFN16-16F	1-11-1/2 NPTF	2.10	3.91	1.65	1.50	0.380
1-1/4	BPGFN20-20F	1-1/4-11-1/2 NPTF	2.22	4.88	2.06	1.88	0.576



aerospace
 climate control
 electromechanical
 filtration
 fluid & gas handling
 hydraulics
 pneumatics
 process control
 sealing & shielding



Quick Coupling Products

Quick Couplings, Swivels, Valves,
 Diagnostic Equipment
 Catalog 3800 USA | February 2014



ENGINEERING YOUR SUCCESS.

Quick Coupling Division Locations



Minneapolis, MN



Grantsburg, WI



Chetek, WI



Union City, PA

WARNING

FAILURE OR IMPROPER SELECTION OR IMPROPER USE OF THE PRODUCTS DESCRIBED HEREIN OR RELATED ITEMS CAN CAUSE DEATH, PERSONAL INJURY AND PROPERTY DAMAGE.

- This document and other information from Parker-Hannifin Corporation, its subsidiaries and authorized distributors provide product or system options for further investigation by users having technical expertise.
- The user, through its own analysis and testing, is solely responsible for making the final selection of the system and components and assuring that all performance, endurance, maintenance, safety and warning requirements of the application are met. The user must analyze all aspects of the application, follow applicable industry standards, and follow the information concerning the product in the current product catalog and in any other materials provided from Parker or its subsidiaries or authorized distributors.
- To the extent that Parker or its subsidiaries or authorized distributors provide component or system options based upon data or specifications provided by the user, the user is responsible for determining that such data and specifications are suitable and sufficient for all applications and reasonably foreseeable uses of the components or systems.

Offer of Sale

The items described in this document are hereby offered for sale by Parker Hannifin Corporation, its subsidiaries or its authorized distributors. This offer and its acceptance are governed by the provisions stated in the "Offer of Sale."

Table of Contents

Pneumatic Quick Couplings.....Section A

Hydraulic Quick Couplings.....Section B

Thermoplastic Couplings.....Section C

Swivels.....Section D

Valves.....Section E

Diagnostic Products.....Section F

Appendices:

Fluid Compatibility Chart.....I

Safety Guide.....VI

Offer of Sale.....IX

Glossary of Terms.....X



Hydraulic Quick Couplings

Double Shut-Off and Straight-Thru Couplings

Parker hydraulic couplings have a wide variety of designs, each tailored to a particular application or use. This catalog is arranged according to those categories. In each section the construction of a specific design will be detailed. However, based on the valving of the coupling, hydraulic couplings generally fall into one of two groups, either Double Shut-Off or Straight-Thru.

Double Shut-Off couplings are used extensively when it is important to minimize fluid loss upon disconnection. Both halves of the coupler, the body and the nipple, contain shut-off valves. These valves open automatically when the body and nipple are connected, and close automatically when the two halves are disconnected—keeping fluid loss to a minimum.

Parker Straight-Thru couplings have no valves in either half and are ideal for maximum flow application. Their smooth, open bore offers the lowest pressure drop of any quick disconnect coupling, and allows them to be thoroughly cleaned. Since there are no valves in either half, fluid flow should be shut off before the coupling is disconnected.

Rated Pressure

Rated pressure for the Parker hydraulic couplings range from 30 to 15,000 psi, depending on the coupling series, size and materials. Rated pressures as shown in this catalog are defined by ISO 5598, as “the qualified operating pressures which are recommended for a component or a system by the manufacturer.” Parker “Rated Pressures” have been established on the basis of laboratory tests which include, but are not limited to, static burst tests and multiple cycle impulse tests. System characteristics such as high cycling rates and high amplitude shocks either hydraulic or mechanical, can reduce the functioning life of a coupling, even if the system’s nominal pressure falls within the rated pressure range of the coupling.

For assistance in analyzing your application, contact your nearest Parker sales office or the Quick Coupling Division in Minneapolis.

Refer to the Safety Guide at the end of this catalog for considerations when selecting a Quick Coupling.

Refer to the Fluid Compatibility Chart (note Table of Contents) for seal selection assistance for both Double Shut-Off and Straight-Thru couplings.

Checklist for Selecting Quick Couplings

- What are the functional requirements of the coupling?
- What is the maximum working pressure of the application?
- Which seals and body material are compatible with the system’s fluid?
- Is the application static or dynamic?
- What size coupler is required?
- What is the maximum pressure drop suitable for the application?
- Does the application require the ability to connect and disconnect under pressure?
- What is the media temperature and ambient temperature?
- What end configurations are required?
- Is an industry interchange coupler required?
- Is air inclusion and fluid loss a concern in the application?

Table of Contents

Introduction	B-1
Coupling Selection & Ordering Guide	B-3, 4
General Purpose Couplings	
60 Series.....	B-5
Couplers.....	B-7, 8
Nipples.....	B-7, 8
60 Series Steam	B-10
Couplers.....	B-10
Nipples.....	B-10
6600 Series.....	B-11
Couplers.....	B-12
Nipples.....	B-12
H Series	B-14
H Couplers	B-17, 18, 19
H Nipples	B-20, 21, 22
PH Couplers.....	B-19
PH Nipples	B-23
EA Series	B-24
Couplers.....	B-26
Nipples.....	B-27
SM Series.....	B-28
Couplers.....	B-29
Nipples.....	B-29
HP Series.....	B-31
Couplers.....	B-32
Nipples.....	B-32
4000 Series.....	B-33
Couplers.....	B-34
Nipples.....	B-34
4200 Series.....	B-36
Couplers.....	B-37
Nipples.....	B-37
Non-Spill Couplings	
NS Series.....	B-38
Couplers.....	B-39
Nipples.....	B-39
EAS/SAE Adapters.....	B-40
FF/FC Series.....	B-41
Couplers.....	B-42
Nipples.....	B-42
FC Nipples.....	B-44
FEM/FEC Series.....	B-45
Couplers	B-46
Nipples.....	B-47
FEC Nipples	B-48
FH Series.....	B-49
Couplers	B-50
Nipples.....	B-50
FS Series	B-51
Couplers	B-52
Nipples.....	B-52
Repair Kits	B-53

Connect Under Pressure Couplings	
FET Series.....	B-54
Couplers.....	B-55
Nipples.....	B-56
6100 Series.....	B-58
Couplers	B-59, 60
Nipples.....	B-60
8200 Series.....	B-61
Couplers	B-62
Nipples.....	B-62
9200 Series.....	B-63
Couplers	B-64
Nipples.....	B-64
5000 Series.....	B-65
Couplers	B-66
Nipples.....	B-66
75 Series	B-67
Couplers.....	B-69
Nipples.....	B-69
High Pressure Couplings	
71 Series	B-70
Couplers.....	B-72
Nipples.....	B-73
3000 Series.....	B-74
Couplers	B-75
Nipples.....	B-75
TC Series	B-76
Couplers	B-76
Nipples.....	B-76
1141 Series.....	B-77
Couplers	B-77
Nipples.....	B-77
High Flow Couplings	
ST Series	B-78
Couplers	B-79
Nipples.....	B-80
1163 Series.....	B-81
Couplers	B-81
Nipples.....	B-81
HO Series	B-82
Couplers	B-82
Nipples.....	B-82
Mold Coolant Line Couplings	
Moldmate Series.....	B-83
Couplers	B-84, 85
Sub Assemblies & Replacement Parts.....	B-85
Nipples.....	B-87, 88
Special Purpose - Miniature	
DM Series.....	B-89
Couplers	B-90
Nipples.....	B-90
Ordering Information and Options	B-91
Promotional Products-Keychains	B-92



Hydraulic Coupling Selection Guide

Body Sizes (in.)	Valving Style	Material						Locking Mechanism	Std Seal Material*	Std Seal Temp Range	Rated Pressure	Coupling Series
		A	B	S	S3	S6	HP					
General Purpose												
1/8 to 2-1/2	Poppet		■	■	■	■		Ball	Nitrile	-40° to +250° F	800-5000 psi	60 Series
1/4 to 1	Poppet		■					Ball	Ethylene Propylene	-65° to +400° F		60 Series (steam)
1/4 to 1	Poppet		■	■				Ball	Nitrile	-40° to +250° F	4000-5000 psi	6600 Series
1/4 to 4	Poppet/Unvalved	■	■	■		■		Ball	Nitrile	-40° to +250° F	150 - 11000 psi	H Series
1/4 to 3/4	Valved/Unvalved		■	■		■		Ball	Nitrile	-40° to +250° F	vacuum - 3000 psi	EA Series
1/4 to 3/4	Poppet		■	■				Ball	Nitrile	-40° to +250° F	4500-6000 psi	SM Series
1 to 1-1/2	Poppet		■	■				Ball	Nitrile	-40° to +250° F	5000 psi	HP Series
1/4 to 1	Poppet/Ball		■	■				Ball	Nitrile	-40° to +250° F	3000 psi	4000 Series
3/8 to 1/2	Poppet/Ball		■	■				Ball	Nitrile	-40° to +250° F	3000 psi	4200 Series
Non-Spill												
3/8 to 1	Flush Face		■	■				Ball	Nitrile	-40° to +250° F	2500 psi	NS Series
1/2	Flush Face/Poppet		■	■				Ball	Nitrile/Polyurethane	-40° to +250° F	3000-3625 psi	EAS/SAE Adapters
1/4 to 1	Flush Face		■	■				Ball	Nitrile/Polyurethane	-40° to +250° F	3000-5000 psi	FF Series
1/4 to 1	Flush Face		■	■				Ball	Nitrile/Polyurethane	-40° to +250° F	3000-5000 psi	FEM Series
1/4 to 1	Flush Face		■			■		Ball	Fluorocarbon	-15° to +400° F	2000 psi	FS Series
Non-Spill Connect Under Pressure												
3/8 to 1-1/2	Flush Face		■	■				Threads	Nitrile/Polyurethane	-40° to +250° F	6000 psi	FET Series
3/8 to 3/4	Flush Face		■	■				Ball	Nitrile/Polyurethane	-40° to +250° F	3000 psi	FC Series
1/2 to 3/4	Flush Face		■	■				Ball	Nitrile/Polyurethane	-40° to +250° F	3000 psi	FEC Series
3/4 to 1-1/2	Flush Face		■	■				Threads	Nitrile	-40° to +250° F	2000-3000 psi	6100 Series
Connect Under Pressure												
1/2	Poppet		■	■				Ball	Nitrile	-40° to +250° F	3000 psi	8200 Series
1/2	Poppet		■	■				Ball	Nitrile	-40° to +250° F	3000 psi	9200 Series
1/2	Ball		■	■				Threads	Nitrile	-40° to +250° F	2500 psi	5000 Series
3/4 to 4	Poppet		■	■		■		Threads	Nitrile	-40° to +250° F	5000 psi	75 Series
High Pressure												
1/4 to 2	Flush Face		■	■		■	■	Ball	Nitrile	-40° to +250° F	10,000 ps	71 Series
3/8	Flush Face		■	■				Ball	Nitrile	-40° to +250° F	10,000 psi	FH Series
1/4 to 3/8	Ball		■	■				Threads	Polyurethane	-22° to +230° F	10,000 psi	3000 Series
3/8	Poppet		■	■				Ball	Fluorocarbon	-15° to +400° F	10,000 psi	TC Series
1/4	Poppet		■	■				Threads	Polyurethane	-22° to +230° F	10,000 psi	1141 Series
High Flow												
1/8 to 1-1/2	Unvalved		■	■	■			Ball	Nitrile	-40° to +250° F	2500-6700 psi	ST Series
1/4 to 1/2	Unvalved		■	■				Ball	Nitrile	-40° to +250° F	10,000-15,000 psi	H0 Series
3/4	Unvalved		■	■				Ball	Nitrile	-40° to +250° F	200 psi	1163 Series
Mold Coolant												
1/4 to 1/2	Valved/Unvalved		■	■				Ball	Silicone	-20° to +400° F	200 psi	Moldmate
Miniature												
1/8	Poppet		■	■				Ball	Fluorocarbon	-15° to +400° F	250 psi	DM Series

Materials:

A - Aluminum

B - Brass

S - Steel

S3 - 303 Stainless

S6 - 316 Stainless

HP - High Pressure Stainless Steel



*Seal Material Options

Seal Code	Seal Material	Optional for the Following Series
W	Ethylene Propylene	60, 6600, 4000, 4200, 6100, 5000, 8200, 9200, ST
Y	Fluorocarbon	60, 6600, 4000, 4200, 6100, 5000, 8200, 9200, ST, Moldmate
Z	Neoprene	60, 6600, 4000, 4200, 6100, 5000, 8200, 9200, ST
E5	Ethylene Propylene	SM, HP, NS, FF, FEM, FH, FS, HO
E4	Fluorocarbon	SM, HP, NS, FF, FEM, FH, HO
E12	Neoprene	SM, HP, NS, FF, FEM, FH, FS, HO
E35	Perfluoroelastomer	SM, HP, NS, FF, FEM, FH, FS (Contact QCD)
E	Ethylene Propylene	H, EA, 71, 75
V	Fluorocarbon	H, EA, 71, 75

To select proper seal materials, see Fluid Compatibility Chart or contact QCD.
Contact QCD for additional seal material options.



B Hydraulics



60 Series double shut-off couplings are versatile for use across a spectrum of hydraulic applications where fluid lines require connection and disconnection. Couplers and nipples are available in a wide range of sizes and materials.

Features:

- Accepts ISO 7241-1, Series B compliant nipples
- Poppet valves along with a metal to metal valve stop maintains valve alignment and prevents flow checking
- Steel, brass, and stainless steel material options
- Brass couplers have double O-rings and stainless steel locking balls
- Steel coupler sleeve and steel nipple body are hardened to be wear resistant
- Standard end configurations include female pipe and straight thread ORB
- Optional Sleeve-Lok and alternative seal materials available

Applications include:

- Industrial hydraulic lines
- Food and chemical processing
- Water and coolant lines
- Mobile equipment
- May be used with some gases

General Purpose Specifications																	
Industry Standard: Parker 60 Series couplings comply with ISO 7241 Series B Standard.																	
ANSI/ISO Pressure Rating: Dynamic applications with normal to moderate hydraulic shocks such as general industrial equipment, hydraulic presses, agricultural equipment, etc. Impulse tested at a multiple (125% to 133%) of rated pressure.									Low Cycle, Non-pulsating Pressure Rating: Applications with lower cycle life and no severe cyclic pressure fluctuations, essentially steady pressure during an operating cycle. Typical applications include hydraulic jacks, mine roof support systems, and high pressure fluid transfer (pumping water or slurry in oil wells). Minor pump ripple is considered non-pulsating. Impulse tested at rated pressure.								
Body Size	1/8	1/4	3/8	1/2	3/4	1	1 1/2	2 1/2	1/8	1/4	3/8	1/2	3/4	1	1 1/2	2 1/2	
	Rated Pressure (psi)								Rated Pressure (psi)								
Brass	1000	1000	1000	1000	1000	1000	800	800	3000	3700	2700	3500	2200	1500	1500	1200	
Stainless steel	2000	2000	1500	1500	1500	1000	1000	1000	5000	5000	5000	5000	3000	3000	1500	1500	
Steel	5000	5000	4000	4000	2500	2000	1000	1000	5000	5000	4000	4000	2500	2000	1500	1500	
Steel w/ HD nipple	N/A	5000	4000	4000	3000	3000	N/A	N/A	5000	5000	4000	4000	3000	3000	N/A	N/A	
Seal Temperature Range: Nitrile: -40°F to +250°F (Standard seal for Brass, Steel, & 303 Stainless Steel couplings). Fluorocarbon: -15°F to +400°F (Standard seal for 316 Stainless Steel couplings). Other Seal materials: Contact the Division for availability.																	
Vacuum Data: 27.4 inches Hg (-0.9 Bar) both connected and disconnected. (1-1/2" and 2-1/2" body size 60 Series couplings are not recommended for service in disconnected mode)																	

Body Size	1/8	1/4	3/8	1/2	3/4	1	1 1/2	2 1/2
Rated Flow (gpm)	.8	3	6	12	28	50	100	200



Performance

B Hydraulics

60 Series (1/8" & 1/4")
Test Fluid: Oil - 150 SUS

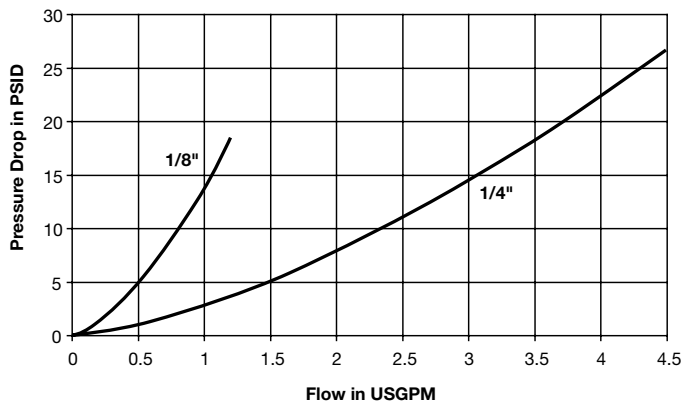

60 Series (3/8" & 1/2")
Test Fluid: Oil - 150 SUS

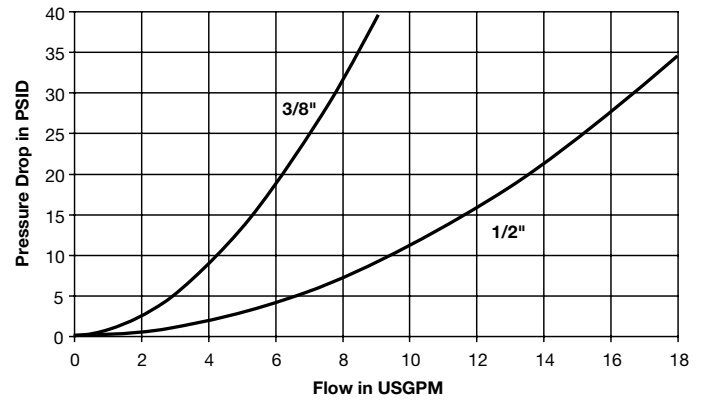

60 Series (3/4" & 1")
Test Fluid: Oil - 150 SUS

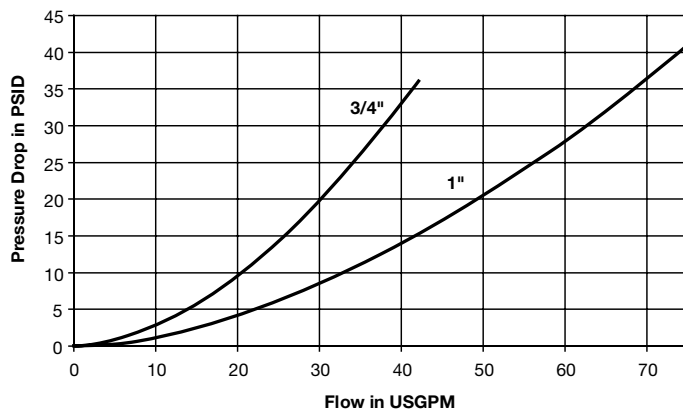

60 Series (1-1/2" & 2-1/2")
Test Fluid: Oil - 200 SUS

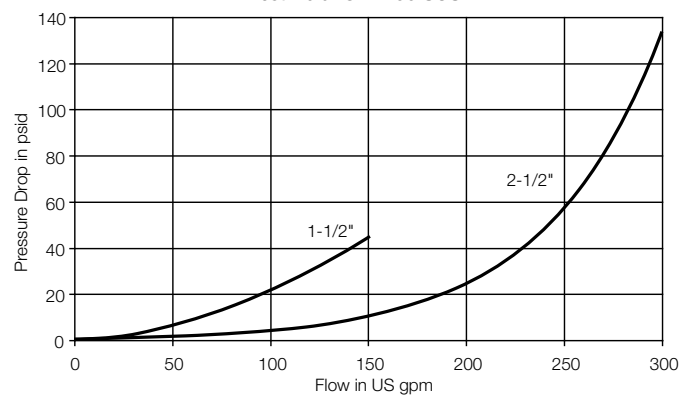



Couplers - Female Thread



Body Size	Part No. Brass	Weight (lbs.)	Part No. Steel	Weight (lbs.)	Part No. Type 303 Stainless	Weight (lbs.)	Part No. Type 316 Stainless	Weight (lbs.)	Thread Size	Overall Length	Wrench Flats	Largest Diameter
1/8	BH1-60	0.16	H1-62	0.16	SH1-62	0.16	SSH1-62Y	0.15	1/8-27 NPTF	1.90	0.68	0.96
1/8	-	-	H1-62-T4	0.18	SH1-62-T4	0.10	SSH1-62Y-T4	0.17	7/16-20 ORB	2.06	0.68	0.96
1/4	BH2-60	0.32	H2-62	0.30	SH2-62	0.30	SSH2-62Y	0.30	1/4-18 NPTF	2.26	0.81	1.14
1/4	-	-	H2-62-T6	0.31	SH2-62-T6	0.31	SSH2-62Y-T6	0.31	9/16-18 ORB	2.41	0.81	1.14
3/8	BH3-60	0.43	H3-62	0.40	SH3-62	0.40	SSH3-62Y	0.40	3/8-18 NPTF	2.49	0.88	1.40
3/8	-	-	H3-62-T8	0.51	SH3-62-T8	0.51	SSH3-62Y-T8	0.51	3/4-16 ORB	2.75	1.00	1.40
1/2	BH4-60	0.80	H4-62	0.73	SH4-62	0.75	SSH4-62Y	0.76	1/2-14 NPTF	2.87	1.12	1.77
1/2	-	-	H4-62-T10	0.78	SH4-62-T10	0.75	SSH4-62Y-T10	0.78	7/8-14 ORB	3.05	1.12	1.77
3/4	BH6-60	1.31	H6-62	1.30	SH6-62	1.31	SSH6-62Y	1.33	3/4-14 NPTF	3.56	1.31	2.14
3/4	-	-	H6-62-T12	1.39	SH6-62-T12	1.34	SSH6-62Y-T12	1.40	1-1/16 - 12 ORB	3.56	1.31	2.14
1	BH8-60	1.95	H8-62	1.95	SH8-62	1.95	SSH8-62Y	1.95	1 - 11 1/2 NPTF	4.18	1.62	2.52
1	-	-	H8-62-T16	1.95	SH8-62-T16	1.95	SSH8-62Y-T16	1.95	1-5/16 - 12 ORB	4.18	1.62	2.52

Nipples - Female Thread



Body Size	Part No. Brass	Weight (lbs.)	Part No. Steel	Weight (lbs.)	Part No. Type 303 Stainless	Weight (lbs.)	Part No. Type 316 Stainless	Weight (lbs.)	Thread Size	Overall Length	Exposed Length*	Wrench Flats	Largest Diameter
1/8	BH1-61	0.04	H1-63	0.03	SH1-63	0.03	SSH1-63Y	0.04	1/8-27 NPTF	1.26	0.44	0.56	0.65
1/8	-	0.06	H1-63-T4	0.05	SH1-63-T4	-	SSH1-63Y-T4	0.06	7/16-20 ORB	1.41	0.59	0.69	0.78
1/4	BH2-61	0.09	H2-63	0.08	SH2-63	0.08	SSH2-63Y	0.08	1/4-18 NPTF	1.54	0.55	0.75	0.87
1/4	-	0.11	H2-63-T6	0.10	SH2-63-T6	0.10	SSH2-63Y-T6	0.10	9/16-18 ORB	1.69	0.70	0.88	1.01
3/8	BH3-61	0.10	H3-63	0.12	SH3-63	0.12	SSH3-63Y	0.12	3/8-18 NPTF	1.68	0.54	0.88	1.01
3/8	-	0.12	H3-63-T8	0.16	SH3-63-T8	0.16	SSH3-63Y-T8	0.14	3/4-16 ORB	1.94	0.80	1.00	1.15
1/2	BH4-61	0.25	H4-63	0.24	SH4-63	0.24	SSH4-63Y	0.24	1/2-14 NPTF	1.94	0.69	1.12	1.30
1/2	-	0.28	H4-63-T10	0.27	SH4-63-T10	0.27	SSH4-63Y-T10	0.27	7/8-14 ORB	2.12	0.87	1.19	1.37
3/4	BH6-61	0.50	H6-63	0.46	SH6-63	0.45	SSH6-63Y	0.46	3/4-14 NPTF	2.43	0.79	1.38	1.59
3/4	-	0.55	H6-63-T12	0.46	SH6-63-T12	0.50	SSH6-63Y-T12	0.50	1-1/16 - 12 ORB	2.54	0.90	1.34	1.59
1	BH8-61	0.76	H8-63	0.76	SH8-63	0.76	SSH8-63Y	0.76	1 - 11 1/2 NPTF	2.91	0.99	1.62	1.88
1	-	0.80	H8-63-T16	0.80	SH8-63-T16	0.80	SSH8-63Y-T16	0.80	1-5/16 - 12 ORB	2.91	0.99	1.62	1.88

* This dimension represents the portion that is exposed when the nipple is inserted into the mating Parker Coupler.



Couplers - Female Thread



Body Size	Part No. Brass	Weight (lbs.)	Part No. Steel	Weight (lbs.)	Part No. Type 303 Stainless	Weight (lbs.)	Part Number Type 316 Stainless	Weight (lbs.)	Thread Size	Overall Length	Wrench Flats	Largest Diameter
1-1/2	BH12-60L	4.58	H12-62L	4.70	SH12-62L	4.68	SSH12-62LY	4.68	1-1/4 - 11 1/2 NPTF	4.86	2.38*	3.00
1-1/2	BH12-60N	4.58	H12-62N	4.70	SH12-62N	4.68	SSH12-62NY	4.68	1-1/2 - 11 1/2 NPTF	4.86	2.38*	3.00
1-1/2	-	4.61	H12-62-T20	4.72	SH12-62-T20	4.71	SSH12-62Y-T20	4.71	1-5/8 - 12 ORB	4.86	2.38*	3.00
1-1/2	-	4.61	H12-62-T24	4.72	SH12-62-T24	4.71	SSH12-62Y-T24	4.71	1-7/8 - 12 ORB	4.86	2.38*	3.00
2-1/2	BH2016-60	11.06	H2016-62	10.58	SH2016-62	-	SSH2016-62Y	-	2 - 11 1/2 NPTF	5.57	3.75	4.10
2-1/2	BH2020-60	11.42	H2020-62	10.91	SH2020-62	-	SSH2020-62Y	-	2 1/2 - 8 NPTF	6.04	3.75	4.10
2-1/2	BH2024-60	-	H2024-62	-	SH2024-62	-	SSH2024-62Y	-	3 - 8 NPTF	6.69	4.00	4.35

*Wrench Flat on 303 Stainless is 2.50 in.

Nipples - Female Thread



Body Size	Part No. Brass	Weight (lbs.)	Part No. Steel	Weight (lbs.)	Part No. Type 303 Stainless	Weight (lbs.)	Part No. Type 316 Stainless	Weight (lbs.)	Thread Size	Overall Length	Exposed Length*	Wrench Flats	Largest Diameter
1-1/2	BH12-61L	2.96	H12-63L	3.10	SH12-63L	3.06	SSH12-63LY	-	1-1/4 - 11 1/2 NPTF	4.76	2.69	2.38‡	2.75†
1-1/2	BH12-61N	2.96	H12-63N	3.10	SH12-63N	3.06	SSH12-63NY	-	1-1/2 - 11 1/2 NPTF	4.76	2.69	2.38‡	2.75†
1-1/2	-	-	H12-63-T20	3.15	SH12-63-T20	3.14	SSH12-63Y-T20	-	1-5/8 - 12 ORB	4.76	2.69	2.38‡	2.75†
1-1/2	-	-	H12-63-T24	3.15	SH12-63-T24	3.14	SSH12-63Y-T24	-	1-7/8 - 12 ORB	4.76	2.69	2.38‡	2.75†
2-1/2	BH2016-61	7.78	H2016-63	7.90	SH2016-63	7.92	SSH2016-63Y	-	2 - 11 1/2 NPTF	5.48	2.90	3.75	4.10
2-1/2	BH2020-61	8.12	H2020-63	8.16	SH2020-63	8.16	SSH2020-63Y	-	2-1/2 - 8 NPTF	5.95	3.37	3.75	4.10
2-1/2	BH2024-61	-	H2024-63	-	SH2024-63	-	SSH2024-63Y	-	3 - 8 NPTF	6.87	4.29	4.00	4.35

* This dimension represents the portion that is exposed when the nipple is inserted into the mating Parker Coupler.

† Largest diameter on Brass is 2.96" across Hex Corners

‡ Hex on 303 Stainless is 2.50 in.

Optional Materials and Features:

(add code to part number)

Code	Description	Part Number Example
suffix -VA	Valve actuator (Nipples)	H3-63-VA
suffix -SL	Sleeve-Lok (Couplers)	H3-62-SL
prefix HD	Heavy duty (Steel Nipples)	HDH3-63
suffix W	Ethylene Propylene seal material (EPR)	H3-63W
suffix Y	Fluorocarbon seal material	H3-62Y
suffix Z	Neoprene seal material	H3-63Z

Contact QCD for availability and additional options.

To select proper seal materials, see Fluid Compatibility Chart or contact QCD.



Replacement Parts		
60 Series Couplers		
Body Size	O-Rings - Nitrile	Back-Up Rings
1/8	50001-013-0010	H67A-28
1/4	50001-015-0010	H67C-28
3/8	50001-116-0010	4118007
1/2	50001-213-0010	4128002
3/4	50001-218-0010	4148001
1	50001-222-0010	4158001
1-1/2	50001-124-0010 (Valve)	
1-1/2	50001-138-0260 (Fitting)	
1-1/2	50001-224-0010 (Body 2 req.)	
2-1/2	50001-133-0010 (Valve)	
2-1/2	50001-234-0260 (Fitting)	
2-1/2	50001-333-0010 (Body)	

Repair Kits				
Couplers			Nipples	
Body Size	Repair Kit Part No.	Used for Part No.	Repair Kit Part No.	Used for Part No.
3/8	H67E-62K	H3-62	H67E-63K	H3-63
3/8	BH67E-60K	BH3-60	BH67E-61K	BH3-61
3/8	SH67E-62K	SH3-62	SH67E-63K	SH3-63
3/8	SSH67-62KY	SSH3-62Y	SSH67E-63KY	SSH3-63Y
1/2	H67F-62K	H4-62	H67F-63K	H4-63
1/2	BH67F-60K	BH4-60	BH67F-61K	BH4-61
1/2	SH67F-62K	SH4-62	SH67F-63K	SH4-63
1/2	SSH67F-62KY	SSH4-62Y	SSH67F-63KY	SSH4-63Y
3/4	H67G-62K	H6-62	H67G-63K	H6-63
3/4	BH67G-60K	BH6-60	BH67G-61K	BH6-61
3/4	SH67G-62K	SH6-62	SH67G-63K	SH6-63
3/4	SSH67G-62KY	SSH6-62Y	SSH67G-63KY	SSH6-63Y
1	H67J-62K	H8-62	H67J-63K	H8-63
1	BH67J-60K	BH8-60	BH67J-61K	BH8-61
1	SH67J-62K	SH8-62	SH67J-63K	SH8-63
1	SSH67J-62KY	SSH8-62Y	SSH67J-63KY	SSH8-63Y

60 Series Dust Plugs and Caps				
Body Size	Coupler Dust Plug Aluminum	Coupler Dust Plug Rubber	Nipple Dust Cap Aluminum	Nipple Dust Cap Rubber
1/8	H1-65	H1-65M	H1-66	H1-66M
1/4	H2-65	H2-65M	H2-66	H2-66M
3/8	H3-65	H3-65M	H3-66	H3-66M
1/2	H4-65	H4-65M	H4-66	H4-66M
3/4	H6-65	H6-65M	H6-66	H6-66M
1	H8-65	H8-65M	H8-66	H8-66M
1-1/2	H12-65	-	H12-66	-
2-1/2	H20P-65	-	H20P-66	-



Hydraulic Quick Couplings

General Purpose

60 Series (Steam)

ISO 7241, Series B

Manual sleeve, EP seal



60 Series Steam couplings are brass with stainless steel locking balls and ethylene propylene seals to withstand temperatures up to 400 F. 1/4 to 1 inch body sizes. 3/8 inch size couplers have a grip-ring sleeve.

Features:

- Accepts ISO 7241-1, Series B compliant nipples
- Poppet valves along with a metal to metal valve stop maintains valve alignment and prevents flow checking
- Brass couplers have double O-rings and stainless steel locking balls
- Standard end configuration is female pipe thread

Applications:

- Steam systems
- Cleaning equipment

Specifications

Body Size	1/4 to 1
Standard Seal Material	Ethylene Propylene
Temperature Range	up to +400°

Repair Kits - Steam Coupling

Body Size	Repair Kit Part No.	Used for Part No.
3/8	H68E-67K	H3-68
3/8	H69E-67K	H3-69

Couplers - Female Pipe Thread



H3-68 has grip-ring sleeve

Body Size	Part No. Brass	Thread Size	Length	Largest Diameter	Wrench Flats	Weight (lbs.)
1/4	BH2-60-STM	1/4-18 NPTF	2.26	1.14	0.81	0.30
3/8*	H3-68	3/8-18 NPTF	2.50	1.77	0.88	0.50
1/2	BH4-60-STM	1/2-14 NPTF	2.87	1.77	1.12	0.75
3/4	BH6-60-STM	3/4-14 NPTF	3.56	2.14	1.31	1.31
1	BH8-60-STM	1-11 1/2 NPTF	4.18	2.52	1.62	1.95

* See Photo for 3/8 inch size coupler configuration.

Nipple - Female Pipe Thread



Body Size	Part No. Brass	Thread Size	Overall Length	Exposed* Length	Largest Diameter	Wrench Flats	Weight (lbs.)
1/4	BH2-61-STM	1/4 - 18 NPTF	1.54	0.65	0.87	0.75	0.08
3/8	H3-69	3/8 - 18 NPTF	1.68	0.52	1.01	0.88	0.13
1/2	BH4-61-STM	1/2 - 14 NPTF	1.94	0.69	1.30	1.12	0.24
3/4	BH6-61-STM	3/4 - 14 NPTF	2.43	0.79	1.59	1.38	0.46
1	BH8-61-STM	1 - 11 1/2 NPTF	2.91	0.99	1.88	1.62	0.76

* This dimension represents the portion that is exposed when the nipple is inserted into the mating Parker Coupler.

Hydraulic Quick Couplings General Purpose

6600 Series ISO 7241 Series A Manual sleeve, poppet valve



The 6600 Series are versatile for use in a wide range of hydraulic applications where fluid lines require connection and disconnection for equipment operation or maintenance

Features:

- Accepts ISO 7241-1, Series A compliant nipples
- Poppet valves and a metal perch to maintain valve alignment and prevent flow checking
- Coupler sleeve and nipple body are hardened to be damage resistant
- Standard end configurations include female pipe and straight thread ORB
- Protective zinc plating with clear trivalent chromate finish

Applications include:

- Snow plows
- Truck trailer connections
- Mobile applications
- Attachments

6600 Series Specifications:

Body Size	Rated Flow (gpm)	Rated Pressure (psi)	Temperature	Body Material	Sleeve Type	Seal Material
1/4	3	5000	-40° F to +250° F	Steel	Manual Connect	Nitrile
3/8	6	4000				
1/2	12	4000				
3/4	28	4000				
1	50	4000				

Performance:

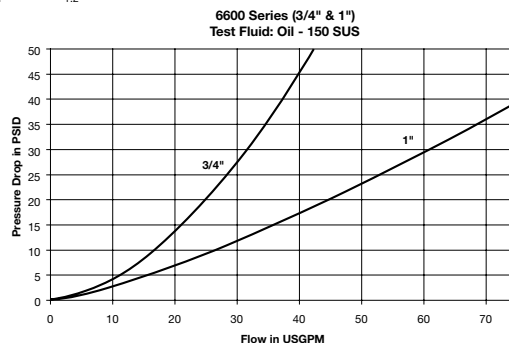
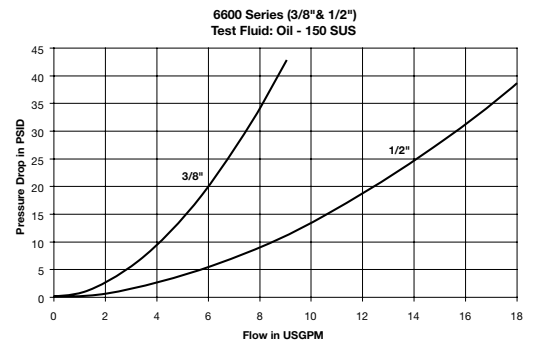
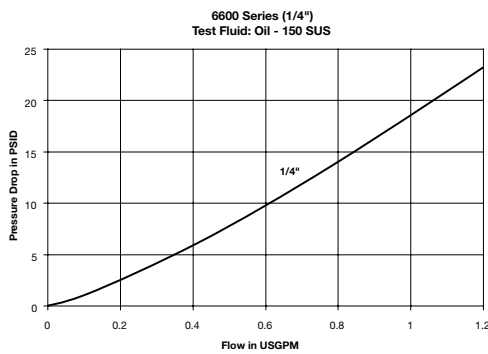



6600 Series Couplers



Body Size	Coupler Part Number	Port End	Valve Type	Length	Largest Diameter	Wrench Flats	Weight (lbs.)
1/4	6601-2-4	1/8-27 NPTF	Poppet	1.85	1.08	0.88	0.27
1/4	6601-4-4	1/4-18 NPTF	Poppet	1.85	1.08	0.88	0.26
3/8	6601-6-6	3/8-18 NPTF	Poppet	2.18	1.27	1.06	0.39
3/8	6608-6-6	9/16-18 ORB	Poppet	2.18	1.27	1.06	0.38
1/2	6601-8-10	1/2-14 NPTF	Poppet	2.75	1.52	1.25	0.67
1/2	6601-12-10	3/4-14 NPTF	Poppet	2.88	1.52	1.38	0.71
1/2	6608-8-10	3/4-16 ORB	Poppet	2.74	1.52	1.25	0.67
1/2	6608-10-10	7/8-14 ORB	Poppet	2.79	1.52	1.25	0.64
1/2	6608-12-10	1 1/16-12 ORB	Poppet	3.01	1.52	1.38	0.77
3/4	6601-12-12	3/4-14 NPTF	Poppet	3.36	1.90	1.62	1.31
3/4	6608-12-12	1 1/16-12 ORB	Poppet	3.35	1.90	1.62	1.31
1	6601-16-16	1-11 1/2 NPTF	Poppet	4.11	2.14	1.88	1.93
1	6608-16-16	1 5/16-12 ORB	Poppet	4.11	2.14	1.88	1.75

6600 Series Nipples



Body Size	Nipple Part Number	Port End	Valve Type	Length	Exposed Length*	Largest Diameter	Wrench Flats	Weight (lbs.)
1/4	6602-2-4	1/8-27 NPTF	Poppet	1.41	0.50	0.65	0.56	0.05
1/4	6602-4-4	1/4-18 NPTF	Poppet	1.41	0.58	0.87	0.75	0.07
3/8	6602-6-6	3/8-18 NPTF	Poppet	1.63	0.72	1.01	0.88	0.11
3/8	6610-6-6	9/16-18 ORB	Poppet	1.63	0.72	1.01	0.88	0.13
1/2	6602-8-10	1/2-14 NPTF	Poppet	2.08	0.78	1.23	1.06	0.21
1/2	6602-12-10	3/4-14 NPTF	Poppet	2.30	0.78	1.59	1.38	0.33
1/2	6610-8-10	3/4-16 ORB	Poppet	2.08	0.76	1.23	1.06	0.22
1/2	6610-10-10	7/8-14 ORB	Poppet	2.08	0.82	1.30	1.12	0.21
1/2	6610-12-10	1 1/16-12 ORB	Poppet	2.30	1.04	1.59	1.38	0.33
3/4	6602-12-12	3/4-14 NPTF	Poppet	2.55	1.18	1.59	1.38	0.49
3/4	6610-12-12	1 1/16-12 ORB	Poppet	2.55	1.18	1.59	1.38	0.47
1	6602-16-16	1-11 1/2 NPTF	Poppet	3.10	1.34	1.88	1.62	0.75
1	6610-16-16	1-5/16-12 ORB	Poppet	3.10	1.34	2.17	1.62	0.72

* This dimension represents the portion of the nipple that is exposed when the nipple and coupler are connected.

6600 Series Replacement Parts	1/4	3/8	1/2	3/4	1
O-Rings - Nitrile	50001-112-0010	50001-115-0010	50001-211-0010	50001-123-0010	50001-126-0010
Back-up Rings	4118006	4118005	50-140-4	4138001	4148002



6600 Series Dust Caps and Plugs



Body Size	Dust Plug (Coupler)	Color/Material	Dust Cap (Nipple)	Weight (lbs.)
1/4	H1-65M	Black Rubber	H1-66M	.02
3/8	TR-37	Black Rubber	TR-37	.04
1/2	5205-4M	Black Rubber	5209-4M	.04
3/4	6659-12M	Black Rubber	6657-12M	.06
1	6659-16M	Black Rubber	6657-16M	.08

Optional Materials and Features:

(add code to part number)

Code	Description	Part Number Example
suffix -SL	Sleeve-Lok (Couplers)	6601-6-6-SL
suffix W	Ethylene Propylene seal material (EPR)	6601-6-6W
suffix Y	Fluorocarbon seal material	6601-6-6Y
suffix Z	Neoprene seal material	6601-6-6Z

Contact QCD for availability and additional options.
To select proper seal materials, see Fluid Compatibility Chart or contact QCD.



Snap-tite H Series couplings have been proven by years of use on hydraulic applications.

H Series is best suited for general purpose fluid applications where either single or double shut-off valving is desired. A wide range of sizes, materials and end configurations are available.

PH version couplers and nipples are valved with a connect-under-pressure feature. These steel couplers and nipples allow connection with H Series valved couplers and nipples when there is a residual pressure on the PH coupler/nipple side. It is recommended that only one half of the connection (coupler or nipple) be PH version, not both.

Features:

- Sizes 1/4" - 4"
- Available in steel, brass, aluminum and 316 stainless steel
- Standard seal material is nitrile with other options available
- Optional sleeve lock helps to prevent accidental disconnection
- Double-shut-off version has low pressure drop
- Manually operated sleeve provides secure connection

Applications include:

- Industrial hydraulic lines
- Water and coolant lines
- Mobile equipment

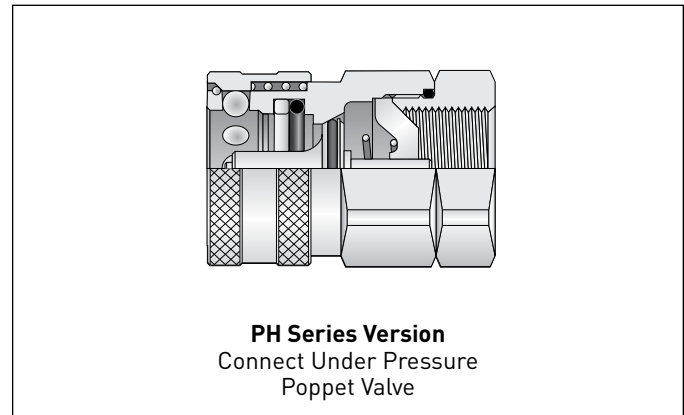
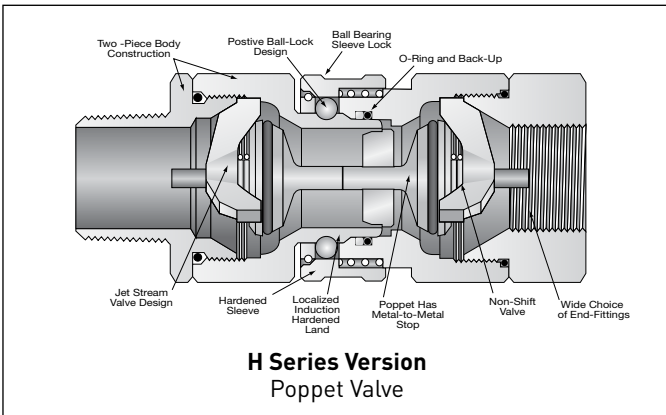

H & PH Series Working Pressures (psi)

Valved on both coupler and nipple (Double Shut-off)
Valved on one half and Unvalved/Plain on other half (Single Shut-off)

Body Size	1/4	3/8	1/2	3/4	1	1-1/4	1-1/2	2	2-1/2	3	4
Steel	6500	4500	4000	3500	2000	1750	1500	1500	1000	750	500
Aluminum	2250	2250	1750	1750	1500	375	375	300	300	200	150
Brass	2250	2250	2000	2000	1750	350	350	400	400	200	150
Stainless Steel	5000	4000	3750	2000	2000	1500	1500	500	400	400	300
Unvalved/Plain on both coupler and nipple (Straight Through)											
Steel	11000	11000	11000	9000	6000	5000	5000	4000	1000	750	500
Aluminum	4000	4000	4000	3500	3000	1000	1000	750	300	200	150
Brass	4000	4000	4000	3500	3000	1000	1000	750	300	200	150
Stainless Steel	10000	8000	8000	7000	4000	3000	3000	1000	400	400	300

NOTE: Pressure ratings were established under static pressure conditions. Therefore, pressure ratings for any given flow, pressure surge and/or vibration may vary from these ratings. Burst pressures listed were taken at the point at which failure rendered the quick disconnect inoperative. (Proof pressure equals 1-1/2 times the working pressure; burst pressure equals 2 times working pressure.)



Performance

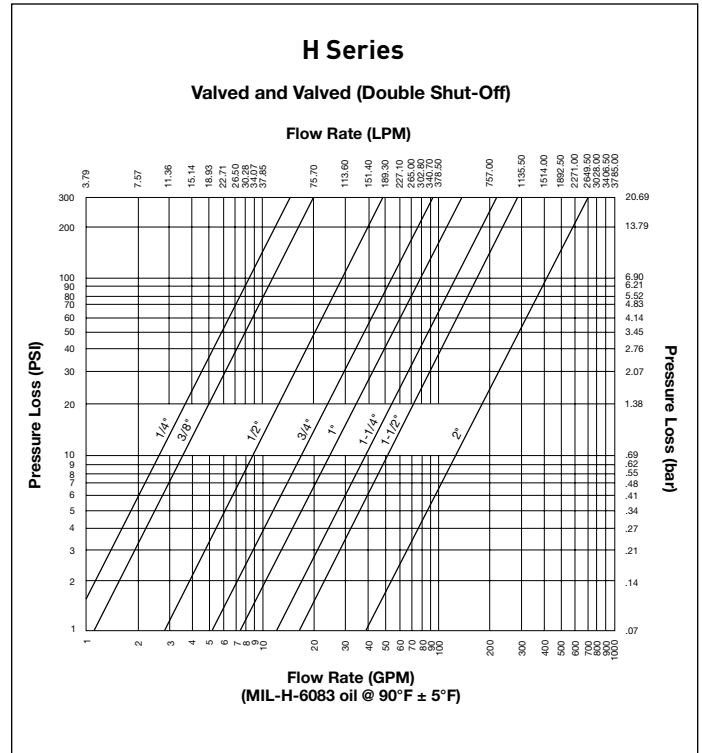
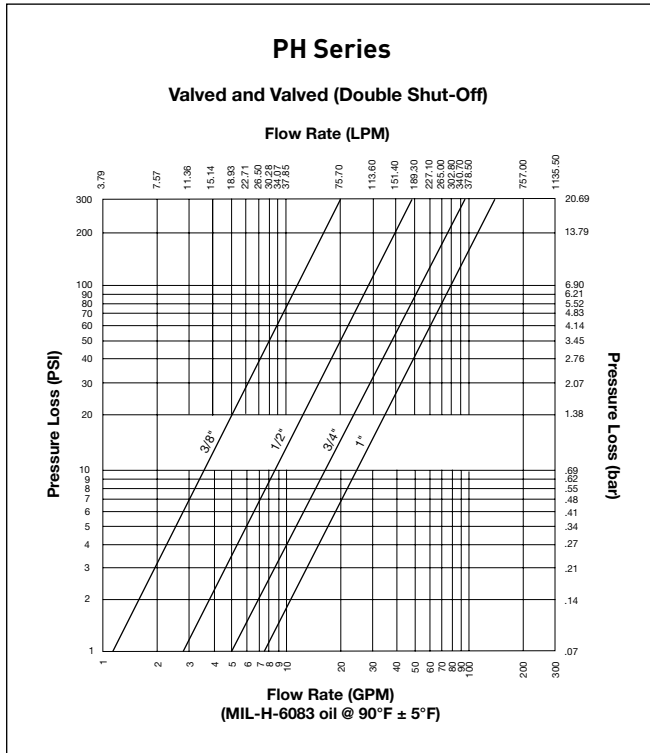

Repair Kits

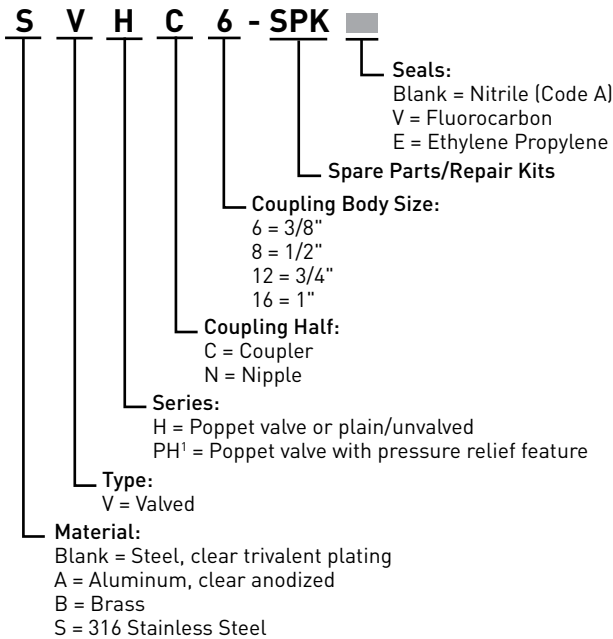

Repair kits include valve spring, valve stop and valve. O-ring installed on 3/8" to 1". 1/4" unit is non-field repairable.

Note: Not all configurations are standard product offering. Contact QCD for price and delivery.

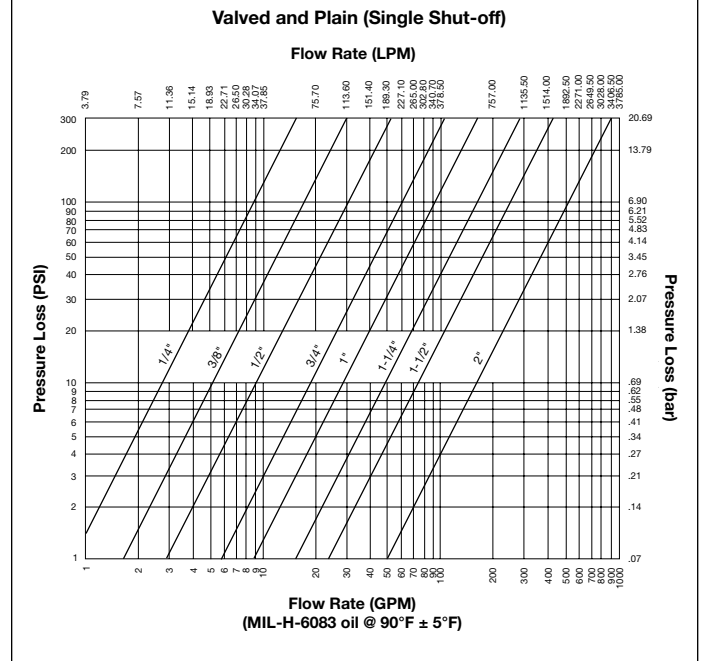

Hydraulic Quick Couplings

General Purpose

Snap-tite H & PH Series

Snap-tite Design

Manual Sleeve, Valved or Unvalved



B Hydraulics

Valve Options		
	H Series Hydraulic Coupler/Nipple	PH Series Hydraulic Coupler/Nipple
Valve Styles:	<ul style="list-style-type: none"> • Poppet Valve • Unvalved/Plain 	<ul style="list-style-type: none"> • Connect-Under-Pressure Poppet Valve
Connection Types:	<ul style="list-style-type: none"> • Double Shut-off • Single Shut-off • Straight Through/Unvalved 	<ul style="list-style-type: none"> • Double Shut-off (connects with valved H Series Coupler or Nipple)
Body Sizes:	1/8" - 4"	3/8" - 1"
Materials:	<ul style="list-style-type: none"> • Steel • 316 Stainless Steel • Aluminum • Brass 	<ul style="list-style-type: none"> • Steel

Replacement Coupler Interface Seals		
Body Size	Nitrile	Fluorocarbon
1/4	H4-56-9	H4-56-9V
3/8	H6-56-9	H6-56-9V
1/2	H8-56-9	H8-56-9V
3/4	H12-56-9	H12-56-9V
1	H16-56-9	H16-56-9V
1-1/4	H20-56-9	H20-56-9V

Replacement Valve Seals			
Body Size	Nitrile	Fluorocarbon	Ethylene Propylene
1-1/4	H20-55A	H20-55V	H20-55E
1-1/2	H24-55A	H24-55V	H24-55E
2	H32-55A	H32-55V	H32-55E

Ordering Guide

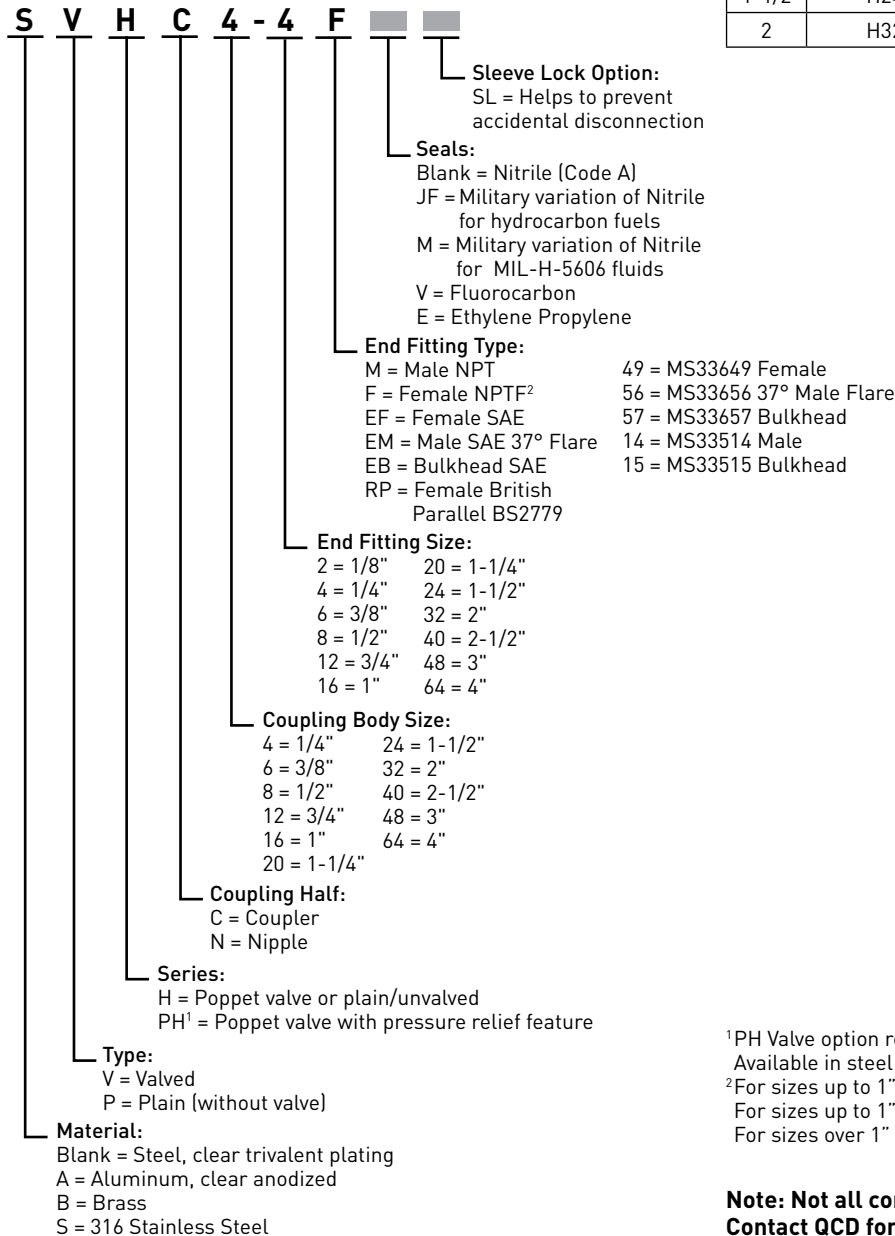

¹PH Valve option recommended on one side, not both. Available in steel only.
²For sizes up to 1" NPTF threads in steel. For sizes up to 1" NPSF threads in stainless steel. For sizes over 1" NPT threads.

Note: Not all configurations are standard product offering. Contact QCD for price and delivery.





H Series Couplers (Aluminum, Brass, Steel) - Female Thread



Body Size	Part Number Aluminum	Part Number Brass	Part Number Steel	Valved or Non-Valved (Plain)	Port End	Length (in)	Largest Diameter	Wrench Flats
1/4	-	-	VHC4-2F	Valved	1/8-27 NPTF	1.65	1.00	0.88
1/4	APHC4-4F	BPHC4-4F	PHC4-4F	Non-Valved	1/4-18 NPTF	1.34	1.02	0.88
1/4	AVHC4-4F	BVHC4-4F	VHC4-4F	Valved	1/4-18 NPTF	1.65	1.19	1.00
1/4	-	-	VHC4-4EF	Valved	7/16-20 UNF	1.80	1.02	0.88
3/8	APHC6-6F	BPHC6-6F	PHC6-6F	Non-Valved	3/8-18 NPTF	1.50	1.19	1.00
3/8	AVHC6-6F	BVHC6-6F	VHC6-6F	Valved	3/8-18 NPTF	1.90	1.19	1.00
3/8	-	-	VHC6-6EF	Valved	9/16-18 UNF	2.20	1.19	1.00
1/2	-	BPHC8-8F	PHC8-8F	Non-Valved	1/2-18 NPTF	1.62	1.39	1.19
1/2	AVHC8-8F	BVHC8-8F	VHC8-8F	Valved	1/2-18 NPTF	2.09	1.39	1.19
1/2	-	-	VHC8-8EF	Valved	3/4-16 UNF	2.19	1.39	1.19
3/4	-	BPHC12-12F	PHC12-12F	Non-Valved	3/4-18 NPTF	1.91	1.73	1.50
3/4	-	BVHC12-12F	VHC12-12F	Valved	3/4-18 NPTF	2.42	1.73	1.50
3/4	-	-	VHC12-12EFV	Valved	1-1/16 - 12 UNF	2.92	1.73	1.50
1	-	BPHC16-16F	PHC16-16F	Non-Valved	1 - 11-1/2 NPTF	2.07	2.17	1.88
1	-	BVHC16-16F	VHC16-16F	Valved	1 - 11-1/2 NPTF	2.67	2.17	1.88
1	-	-	VHC16-16EF	Valved	1-5/16 - 12 UNF	2.94	2.17	1.88
1-1/4	-	BPHC20-20F	PHC20-20F	Non-Valved	1-1/4 - 11-1/2 NPT	2.28	2.31	2.00
1-1/4	-	BVHC20-20F	VHC20-20F	Valved	1-1/4 - 11-1/2 NPT	3.54	2.31	2.00
1-1/2	-	BPHC24-24F	PHC24-24F	Non-Valved	1-1/2 - 11-1/2 NPT	2.57	2.89	2.50
1-1/2	-	BVHC24-24F	VHC24-24F	Valved	1-1/2 - 11-1/2 NPT	3.27	3.18	2.75
2	-	BPHC32-32F	PHC32-32F	Non-Valved	2 - 11-1/2 NPT	2.48	3.75	3.25
2	-	BVHC32-32F	VHC32-32F	Valved	2 - 11-1/2 NPT	3.92	4.33	3.75



H Series Couplers (316 Stainless Steel) - Female Thread



Body Size	Part Number Stainless Steel	Valved or Non-Valved (Plain)	Port End	Length (in)	Largest Diameter	Wrench Flats
1/4	SVHC4-2F	Valved	1/8-27 NPSF*	1.65	1.00	0.88
1/4	SPHC4-4F	Non-Valved	1/4-18 NPSF*	1.34	1.02	0.88
1/4	SVHC4-4F	Valved	1/4-18 NPSF*	1.65	1.19	1.00
3/8	SPHC6-6F	Non-Valved	3/8-18 NPSF*	1.50	1.19	1.00
3/8	SVHC6-6F	Valved	3/8-18 NPSF*	1.90	1.19	1.00
1/2	SPHC8-8F	Non-Valved	1/2-18 NPSF*	1.62	1.39	1.19
1/2	SVHC8-8F	Valved	1/2-18 NPSF*	2.09	1.39	2.09
3/4	SPHC12-12F	Non-Valved	3/4-18 NPSF*	1.91	1.73	1.50
3/4	SVHC12-12F	Valved	3/4-18 NPSF*	2.42	1.73	1.50
1	SPHC16-16F	Non-Valved	1 - 11-1/2 NPSF*	2.07	2.17	1.88
1	SVHC16-16F	Valved	1 - 11-1/2 NPSF*	2.67	2.17	1.88
1-1/4	SPHC20-20F	Non-Valved	1-1/4 - 11-1/2 NPT	2.28	2.31	2.00
1-1/4	SVHC20-20F	Valved	1-1/4 - 11-1/2 NPT	3.54	2.31	2.00
1-1/2	SPHC24-24F	Non-Valved	1-1/4 - 11-1/2 NPT	2.57	2.89	2.50
1-1/2	SVHC24-24F	Valved	1-1/2 - 11-1/2 NPT	3.27	3.18	2.75
2	SPHC32-32F	Non-Valved	2 - 11-1/2 NPT	2.48	3.75	3.25
2	SVHC32-32F	Valved	2 - 11-1/2 NPT	3.92	4.33	3.75

*NPSF thread may be substituted with equivalent NPT thread

H Series Couplers (Aluminum, Brass, Steel) - Male Thread



Body Size	Part Number Aluminum	Part Number Brass	Part Number Steel	Valved or Non-Valved (Plain)	Port End	Length (in)	Largest Diameter	Wrench Flats
1/4	-	-	VHC4-2M	Valved	1/8-27 NPT	1.90	1.00	0.88
1/4	AVHC4-4M	BVHC4-4M	VHC4-4M	Valved	1/4-18 NPT	2.09	1.02	0.88
3/8	AVHC6-6M	-	VHC6-6M	Valved	3/8-18 NPT	2.19	1.19	1.00
3/8	-	BVHC6-6M	-	Valved	3/8-18 NPT	1.90	1.19	1.00
1/2	-	BVHC8-8M	-	Valved	1/2-18 NPT	2.57	1.39	1.19
1/2	-	-	VHC8-8M	Valved	1/2-18 NPT	2.46	1.39	1.19
3/4	-	BVHC12-12M	VHC12-12M	Valved	3/4-18 NPT	2.88	1.73	1.50
1	-	BVHC16-16M	VHC16-16M	Valved	1-11-1/2 NPT	3.21	2.17	1.88
2	-	-	VHC32-32M	Valved	2-11-1/2 NPT	4.54	4.33	3.75



H Series Couplers (316 Stainless Steel) - Male Thread



Body Size	Part Number	Valved or Non-Valved (Plain)	Port End	Length (in)	Largest Diameter	Wrench Flats
1/4	SVHC4-4M	Valved	1/4-18 NPT	2.09	1.02	0.88
3/8	SVHC6-6M	Valved	3/8-18 NPT	2.19	1.19	1.00
1/2	SVHC8-8M	Valved	1/2-18 NPT	2.57	1.39	1.19
3/4	SVHC12-12M	Valved	3/4-18 NPT	2.88	1.73	1.50
1	SVHC16-16M	Valved	1 - 11-1/2 NPT	3.21	2.17	1.88

H Series Couplers (Steel) - Male SAE 37 Degree Flare



Body Size	Part Number	Valved or Non-Valved (Plain)	Port End	Length (in)	Largest Diameter	Wrench Flats
1/4	VHC4-4EM	Valved	7/16-20 UNF	2.80	1.02	0.88
3/8	VHC6-6EM	Valved	9/16-18 UNF	2.24	1.19	1.00
1/2	VHC8-8EM	Valved	3/4-16 UNF	2.46	1.39	1.19
3/4	VHC12-12EM	Valved	1-1/6 - 12 UNF	3.05	1.73	1.50

PH Series Connect-Under-Pressure Couplers (Steel) - Female Thread



Body Size	Part Number	Valved or Non-Valved (Plain)	Port End	Length (in)	Largest Diameter	Wrench Flats
3/8	VPHC6-6F	Valved	3/8-18 NPTF	1.90	1.19	1.00
1/2	VPHC8-8F	Valved	1/2-14 NPTF	2.09	1.39	1.19
3/4	VPHC12-12EF	Valved	1-1/16 - 12 UNF	2.92	1.73	1.50
3/4	VPHC12-12F	Valved	3/4-14 NPTF	2.42	1.73	1.50



H Series Nipples (Aluminum, Brass, Steel) - Female Thread



Body Size	Part Number Aluminum	Part Number Brass	Part Number Steel	Valved or Non-Valved (Plain)	Port End	Length (in)	Largest Diameter	Wrench Flats
1/4	-	BPHN4-2F	PHN4-2F	Non-Valved	1/8-27 NPTF	1.11	0.62	0.56
1/4	-	-	VHN4-2F	Valved	1/8-27 NPTF	1.59	1.00	0.88
1/4	APHN4-4F	BPHN4-4F	-	Non-Valved	1/4-18 NPTF	1.32	0.73	0.88
1/4	AVHN4-4F	BVHN4-4F	-	Valved	1/4-18 NPTF	1.59	1.02	0.88
1/4	-	-	PHN4-4F	Valved	1/4-18 NPTF	1.32	0.73	0.63
1/4	-	-	VHN4-4F	Valved	1/4-18 NPTF	1.65	1.19	1.00
3/8	APHN6-6F	BPHN6-6	-	Non-Valved	3/8-18 NPTF	1.52	0.94	1.00
3/8	-	-	PHN6-6F	Non-Valved	3/8-18 NPTF	1.52	0.94	0.81
3/8	AVHN6-6F	BVHN6-6F	VHN6-6F	Valved	3/8-18 NPTF	1.84	1.19	1.00
1/2	AVHN8-8F	-	-	Valved	1/2-18 NPTF	1.98	1.19	1.00
1/2	-	BPHN8-8F	PHN8-8F	Non-Valved	1/2-18 NPTF	1.72	1.15	1.00
1/2	-	BVHN8-8F	VHN8-8F	Valved	1/2-18 NPTF	1.98	1.39	1.19
1/2	-	-	VHN8-8EF	Valved	3/4-16 UNF	2.08	1.39	1.19
3/4	-	BPHN12-12F	PHN12-12F	Non-Valved	3/4-18 NPTF	1.92	1.37	1.19
3/4	-	BVHN12-12F	VHN12-12F	Valved	3/4-18 NPTF	2.29	1.73	1.50
3/4	-	-	VHN12-12EF	Valved	1-1/16 - 12 UNF	2.79	1.73	1.50
1	-	BPHN16-16F	PHN16-16F	Non-Valved	1 - 11-1/2 NPTF	2.10	1.73	1.50
1	-	BVHN16-16F	VHN16-16F	Valved	1 - 11-1/2 NPTF	2.55	2.17	1.88
1	-	-	VHN16-16EF	Valved	1-5/16 - 12 UNF	2.82	2.17	1.88
1-1/4	-	BPHN20-20F	PHN20-20F	Non-Valved	1-1/4 - 11-1/2 NPTF	2.22	2.17	1.88
1-1/4	-	BVHN20-20F	VHN20-20F	Valved	1-1/4 - 11-1/2 NPTF	3.41	2.31	2.00
1-1/2	-	BPHN24-24F	PHN24-24F	Non-Valved	1-1/2 - 11-1/2 NPTF	2.44	2.46	2.13
1-1/2	-	BVHN24-24F	VHN24-24F	Valved	1-1/2 - 11-1/2 NPTF	3.11	3.18	2.75
2	-	BPHN32-32F	PHN32-32F	Non-Valved	2 - 11-1/2 NPTF	2.60	3.18	2.75
2	-	BVHN32-32F	VHN32-32F	Valved	2 - 11-1/2 NPTF	3.72	4.33	3.75



H Series Nipples (316 Stainless Steel) - Female Thread



Body Size	Part Number	Valved or Non-Valved (Plain)	Port End	Length (in)	Largest Diameter	Wrench Flats
1/4	SPHN4-2F	Non-Valved	1/8-27 NPSF*	1.11	0.62	0.56
1/4	SVHN4-2F	Valved	1/8-27 NPSF*	1.59	1.00	0.56
1/4	SPHN4-4F	Non-Valved	1/4-18 NPSF*	1.32	0.73	0.63
1/4	SVHN4-4F	Valved	1/4-18 NPSF*	1.59	1.02	0.88
3/8	SPHN6-6F	Non-Valved	3/8-18 NPSF*	1.52	0.94	0.81
3/8	SVHN6-6F	Valved	3/8-18 NPSF*	1.84	1.19	1.00
1/2	SPHN8-8F	Non-Valved	1/2-18 NPSF*	1.72	1.15	2.00
1/2	SVHN8-8F	Valved	1/2-18 NPSF*	1.98	1.39	1.19
3/4	SPHN12-12F	Non-Valved	3/4-18 NPSF*	1.92	1.37	1.19
3/4	SVHN12-12F	Valved	3/4-18 NPSF*	2.29	1.73	1.50
1	SPHN16-16F	Non-Valved	1 - 11-1/2 NPSF*	2.10	1.73	1.50
1	SVHN16-16F	Valved	1 - 11-1/2 NPSF*	2.55	2.17	1.88
1-1/4	SPHN20-20F	Non-Valved	1-1/4 - 11-1/2 NPTF	2.22	2.17	1.88
1-1/4	SVHN20-20F	Valved	1-1/4 - 11-1/2 NPTF	3.41	2.31	1.88
1-1/2	SPHN24-24F	Non-Valved	1-1/2 - 11-1/2 NPTF	2.44	2.46	2.13
1-1/2	SVHN24-24F	Valved	1-1/2 - 11-1/2 NPTF	3.11	3.18	3.75
2	SPHN32-32F	Non-Valved	2 - 11-1/2 NPTF	2.60	3.18	2.75
2	SVHN32-32F	Valved	2 - 11-1/2 NPTF	3.72	4.33	3.75

*NPSF thread may be substituted with equivalent NPT thread



H Series Nipples (Aluminum, Brass, Steel) - Male Thread



Body Size	Part Number Aluminum	Part Number Brass	Part Number Steel	Valved or Non-Valved (Plain)	Port End	Length (in)	Largest Diameter	Wrench Flats
1/4	-	BPHN4-2M	-	Non-Valved	1/8-27 NPT	1.22	0.64	0.56
1/4	-	-	PHN4-2M	Non-Valved	1/8-27 NPT	1.11	0.62	0.56
1/4	-	-	VHN4-2M	Valved	1/8-27 NPT	1.85	1.00	0.88
1/4	APHN4-4M	BPHN4-4M	PHN4-4M	Non-Valved	1/4-18 NPT	0.78	0.65	0.56
1/4	AVHN4-4M	BVHN4-4M	VHN4-4M	Valved	1/4-18 NPT	2.03	1.02	0.88
3/8	-	BPHN6-6M	PHN6-6M	Non-Valved	3/8-18 NPT	0.98	0.80	0.69
3/8	AVHN6-6M	BVHN6-6M	VHN6-6M	Valved	3/8-18 NPT	2.13	1.19	1.00
1/2	-	BPHN8-8M	PHN8-8M	Non-Valved	1/2-18 NPT	1.01	1.02	0.88
1/2	-	BVHN8-8M	VHN8-8M	Valved	1/2-18 NPT	2.46	1.39	1.19
3/4	-	BPHN12-12M	PHN12-12M	Non-Valved	3/4-18 NPT	1.14	1.22	1.06
3/4	-	BVHN12-12M	VHN12-12M	Valved	3/4-18 NPT	2.75	1.73	1.50
1	-	BPHN16-16M	-	Non-Valved	1 - 11-1/2 NPT	1.16	1.59	1.38
1	-	-	PHN16-16M	Non-Valved	1-11-1/2 NPT	1.16	1.73	1.88
1	-	BVHN16-16M	VHN16-16M	Valved	1 - 11-1/2 NPT	3.09	2.17	1.88
1-1/4	-	-	VHN20-20M	Valved	1-1/4 - 11-1/2 NPT	3.46	2.31	2.00
2	-	-	PHN32-32M	Non-Valved	2 - 11-1/2 NPT	2.03	2.89	2.50

H Series Nipples (316 Stainless Steel) - Male Thread



Body Size	Part Number	Valved or Non-Valved (Plain)	Port End	Length (in)	Largest Diameter	Wrench Flats
1/4	SPHN4-2M	Non-Valved	1/8-27 NPT	1.22	0.64	0.56
1/4	SPHN4-4M	Non-Valved	1/4-18 NPT	0.78	0.65	0.56
1/4	SVHN4-4M	Valved	1/4-18 NPT	2.03	1.02	0.88
3/8	SPHN6-6M	Non-Valved	3/8-18 NPT	0.98	0.80	0.69
3/8	SVHN6-6M	Valved	3/8-18 NPT	2.13	1.19	1.00
1/2	SPHN8-8M	Non-Valved	1/2-18 NPT	1.01	1.02	0.88
1/2	SVHN8-8M	Valved	1/2-18 NPT	2.46	1.39	1.19
3/4	SVHN12-12M	Valved	3/4-18 NPT	2.75	1.73	1.50
1	SVHN16-16M	Valved	1 - 11-1/2 NPT	3.09	2.17	1.80
1-1/4	SVHN20-20M	Valved	1-1/4 - 11-1/2 NPT	3.46	2.31	2.00



H Series Nipples (Steel) - Male SAE 37 Degree Flare



Body Size	Part Number	Valved or Non-Valved (Plain)	Port End	Length (in)	Largest Diameter	Wrench Flats
1/4	VHN4-4EM	Valved	7/16-20 UNF	2.02	1.02	0.88
3/8	VHN6-6EM	Valved	9/16-18 UNF	2.24	1.19	1.00
1/2	VHN8-8EM	Valved	3/4-16 UNF	2.35	1.39	1.19
3/4	VHN12-12EM	Valved	1-1/6 - 12 UNF	2.92	1.73	1.50

PH Series Connect-Under-Pressure Nipples (Steel)



Body Size	Part Number	Valved or Non-Valved (Plain)	Port End	Length (in)	Largest Diameter	Wrench Flats
1/2	VPHN8-8F	Valved	1/2-14 NPTF (Female)	1.98	1.39	1.19
1/2	VPHN8-8EM	Valved	3/4-16 UNF (Male)	2.35	1.39	1.19

H Series Dust Plugs and Caps



Body Size	Coupler Dust Plug Plastic	Coupler Dust Plug Aluminum	Nipple Dust Cap Plastic	Nipple Dust Cap Aluminum	Nipple Pressure Cap
1/4	PDP-4	AMPH-4	PDC-4	ADCH-4	MCH-4
3/8	PDP-6	AMPH-6	PDC-6	ADCH-6	MCH-6
1/2	PDP-8	AMPH-8	PDC-8	ADCH-8	MCH-8
3/4	PDP-12	AMPH-12	PDC-12	ADCH-12	MCH-12
1	PDP-16	AMPH-16	PDC-16	ADCH-16	MCH-16
1-1/4	-	AMPH-20	-	ADCH-20	MCH-20
1-1/2	-	AMPH-24	-	ADCH-24	MCH-24
2	-	AMPH-32	-	ADCH-32	MCH-32
2-1/2	-	AMPH-40	-	ADCH-40	MCH-40
3	-	AMPH-48	-	ADCH-48	MCH-48



EA Series couplings are designed specifically for vacuum and medium pressure service, providing a dependable means for speeding fluid line changeover in autoclave applications.

Features:

- Vacuum capability
- Available in a variety of materials
- Wide range of sizes
- Nitrile is standard seal material, other options available

Applications include:

- Aircraft fabrication
- Plastic molding
- Horizontal boring and dewatering



B Hydraulics

EA Series Specifications				
Body Size	Force to Connect (Valved and Valved)		Spillage on Disconnect (Valved and Valved)	
	Internal Pressure (psi)	Force to Connect (lbs)	With 10 psi Internal Pressure (cc or ml)	With 50 psi Pressure (cc or ml)
1/4	200	50	1.2	1.5
3/8	200	60	1.4	2.5
1/2	200	95	4.2	4.6
3/4	100	95	10.5	11.6

EA Series Pressure Ratings						
Body Size	Steel		316 Stainless Steel		Brass	
	Maximum Working (psi)	Minimum Burst (psi)	Maximum Working (psi)	Minimum Burst (psi)	Maximum Working (psi)	Minimum Burst (psi)
1/4	3000	6000	3000	6000	1500	3000
3/8	3000	6000	3000	6000	1500	3000
1/2	3000	6000	3000	6000	1500	3000
3/4	2000	4000	2000	4000	1500	3000

Pressure ratings were established under static pressure conditions. Therefore, pressure ratings for any given flow, pressure surge and/or vibration may vary from those ratings.

Vacuum Capability at Standard Barometric Conditions								
	1/4		3/8		1/2		3/4	
	in.hg	atm	in.hg	atm	in.hg	atm	in.hg	atm
Connected	29.7	.99	29.7	.99	29.7	.99	29.7	.99
Coupler or Nipple Alone (disconnected)	29.7	.99	29.7	.99	29.7	.99	29.7	.99



Performance

EA Series Valved & Valved (Double Shut-off)

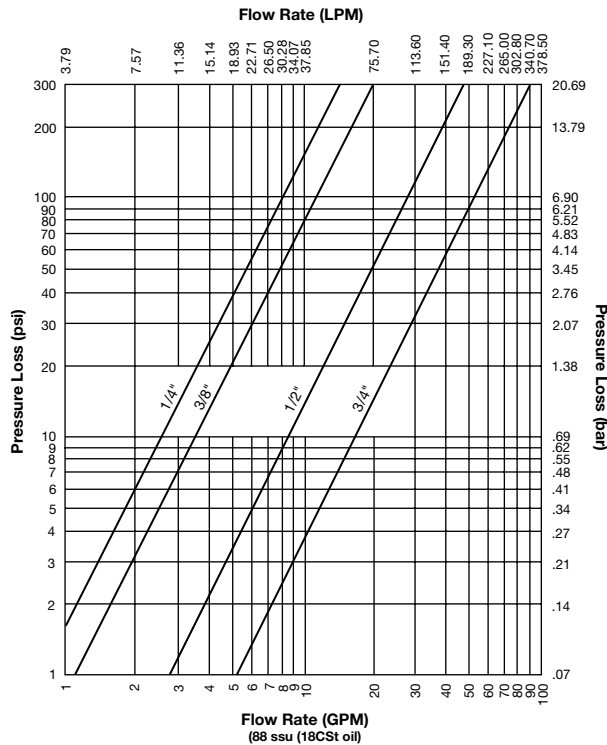

EA Series Valved & Plain (Single Shut-off)

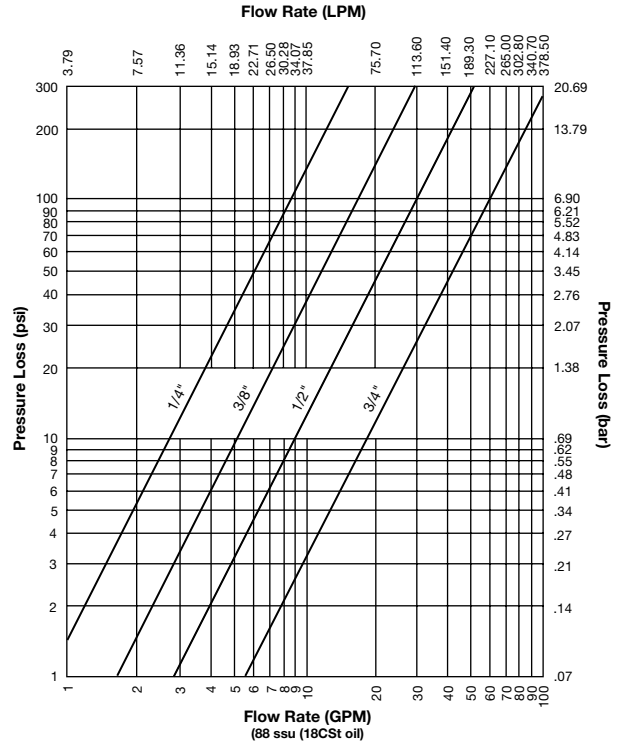

EA Series Repair Kits and Replacement Parts			
Body Size	Part Number	Description	Seal Material
1/2	VEAC8-SPK	Coupler Valve Repair Kit	Nitrile
1/2	VEAN8-SPK	Nipple Valve Repair Kit	Nitrile
1/4	EA4-58AS	Coupler Interface Seal	Aflas
1/2	EA8-58V	Coupler Interface Seal	Fluorocarbon
3/4	EA12-55A	Valve Seal	Nitrile
3/4	EA12-58A	Coupler Interface Seal	Nitrile

Repair Kits

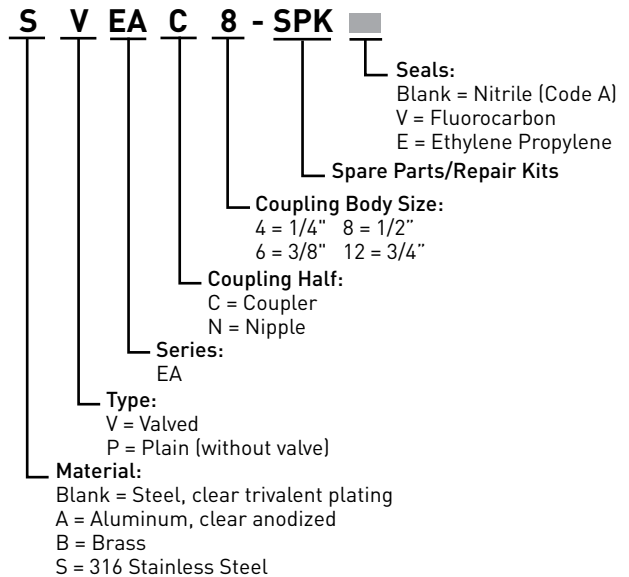

Optional Seal Materials for Couplers and Valved Nipples

(add code to part number)

Code	Description	Part Number Example
suffix V	Fluorocarbon seal material	VEAN4-4FV
suffix E	Ethylene Propylene seal material (EPR)	VEAC6-6ME
suffix AS	Aflas seal material	VEAC6-6FAS

Contact QCD for availability and additional options.
To select proper seal materials, see Fluid Compatibility Chart or contact QCD.



EA Series Couplers (Brass, Steel, 316 Stainless Steel) - Female Thread



Body Size	Part Number Brass	Part Number Steel	Port End	Part Number 316 Stainless Steel	Port End*	Valved or Non-Valved (Plain)	Length (in)	Largest Diameter	Wrench Flats
1/4	BPEAC4-4F	PEAC4-4F	1/4-18 NPTF	SPEAC4-4F	1/4-18 NPSF	Non-Valved	1.33	1.13	0.88
1/4	BVEAC4-4F	VEAC4-4F	1/4-18 NPTF	SVEAC4-4F	1/4-18 NPSF	Valved	1.61	1.13	0.88
3/8	BPEAC6-6F	PEAC6-6F	3/8-18 NPTF	-	-	Non-Valved	1.58	1.31	1.00
3/8	BVEAC6-6F	VEAC6-6F	3/8-18 NPTF	-	-	Valved	1.86	1.31	1.00
1/2	BPEAC8-8F	PEAC8-8F	1/2-14 NPTF	-	-	Non-Valved	1.70	1.44	1.19
1/2	BVEAC8-8F	VEAC8-8F	1/2-14 NPTF	SVEAN8-8F	1/2-14NPSF	Valved	2.09	1.44	1.19
3/4	BPEAC12-12F	-	3/4-14 NPTF	SPEAN12-12F	3/4-14 NPSF	Non-Valved	2.41	1.88	1.50
3/4	BVEAC12-12F	VEAC12-12F	3/4-14 NPTF	SVEAN12-12F	3/4-14 NPSF	Valved	1.91	1.88	1.50

EA Series Couplers (Brass, Steel, 316 Stainless Steel) - Male Thread



Body Size	Part Number Brass	Part Number Steel	Port End	Part Number 316 Stainless Steel	Port End*	Valved or Non-Valved (Plain)	Length (in)	Largest Diameter	Wrench Flats
1/4	-	PEAC4-4M	1/4-18 NPTF	SPEAC4-4M	1/4-18 NPSF	Non-Valved	1.48	1.13	0.88
1/4	-	VEAC4-4M	1/4-18 NPTF	SVEAC4-2M	1/4-18 NPSF	Valved	2.05	1.13	0.88
3/8	BVEAC6-6M	VEAC6-6M	3/8-18 NPTF	-	-	Valved	2.15	1.31	1.00
1/2	BVEAC8-8M	VEAC8-8M	1/2-14 NPTF	SVEAC8-8M	1/2-14 NPSF	Valved	2.46	1.44	1.19
3/4	BVEAC12-12M	VEAC12-12M	3/4-14 NPTF	-	-	Valved	2.87	1.88	1.50

*May be substituted with NPT threads

Contact QCD for additional sizes, materials and end configurations.



EA Series Nipples (Brass, Steel, 316 Stainless Steel) - Female Thread



Body Size	Part Number Brass	Part Number Steel	Port End	Part Number 316 Stainless Steel	Port End*	Valved or Non-Valved (Plain)	Length (in)	Largest Diameter	Wrench Flats
1/4	-	-	-	SVEAN4-2F	1/8-27 NPSF	Valved	1.61	1.00	0.88
1/4	BPEAN4-4F	PEAN4-4F	1/4-18 NPTF	SPEAN4-4F	1/4-18 NPSF	Non-Valved	1.33	0.73	0.62
1/4	-	VEAN4-4F	1/4-18 NPTF	SVEAN4-4F	1/4-18 NPSF	Valved	1.61	1.00	0.88
3/8	BPEAN6-6F	PEAN6-6F	3/8-18 NPTF	-	-	Non-Valved	1.58	0.94	0.81
3/8	BVEAN6-6F	VEAN6-6F	3/8-18 NPTF	-	-	Valved	1.86	1.15	1.00
1/2	BPEAN8-8F	PEAN8-8F	1/2-14 NPTF	-	-	Non-Valved	1.70	1.15	1.00
1/2	BVEAN8-8F	VEAN8-8F	1/2-14 NPTF	SVEAN8-8F	1/2-14 NPSF	Valved	2.09	1.31	1.19
3/4	BPEAN12-12F	-	3/4-14 NPTF	SPEAN12-12F	3/4-14 NPSF	Non-Valved	2.05	1.37	1.19
3/4	BVEAN12-12F	VEAN12-12F	3/4-14 NPTF	SVEAN12-12F	3/4-14 NPSF	Valved	2.29	1.73	1.50

EA Series Nipples (Brass, Steel, 316 Stainless Steel) - Male Thread



Body Size	Part Number Brass	Part Number Steel	Port End	Part Number 316 Stainless Steel	Port End*	Valved or Non-Valved (Plain)	Length (in)	Largest Diameter	Wrench Flats
1/4	-	PEAN4-4M	1/4-18 NPTF	SPEAN4-4M	1/4-18 NPSF	Non-Valved	1.43	0.65	0.56
1/4	-	VEAN4-4M	1/4-18 NPTF	SVEAN4-4M	1/4-18 NPSF	Valved	2.21	1.02	0.88
3/8	BVEAN6-6M	VEAN6-6M	3/8-18 NPTF	-	-	Valved	2.15	1.15	1.00
1/2	BVEAN8-8M	VEAN8-8M	1/2-14 NPTF	SVEAN8-8M	1/2-14 NPSF	Valved	2.46	1.31	1.19
3/4	BVEAN12-12M	VEAN12-12M	3/4-14 NPTF	-	-	Valved	2.75	1.65	1.50

*May be substituted with NPT threads
Contact QCD for additional sizes, materials and end configurations.

EA Series Dust Plugs and Caps



Body Size	Coupler Dust Plug Plastic	Coupler Dust Plug Aluminum	Nipple Dust Cap Plastic	Nipple Dust Cap Aluminum	Nipple Pressure Cap
1/4	PDP-4	AMPE-4	PDC-4	ADCE-4	MCE-4
3/8	PDP-6	AMPE-6	PDC-6	ADCE-6	MCE-6
1/2	PDP-8	AMPE-8	PDC-8	ADCE-8	MCE-8
3/4	PDP-12	AMPE-12	PDC-12	ADCE-12	MCE-12

Hydraulic Quick Couplings

General Purpose

SM Series

High Pressure

Manual sleeve, poppet valve

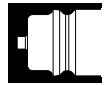

B Hydraulics



SM Series double shut-off couplings are versatile for use across a spectrum of hydraulic applications where fluid lines require connection and disconnection. Couplers and nipples are steel with nitrile seals and are available in 1/4 through 3/4 inch sizes.

Features:

- Rated pressures up to 6000 psi
- Poppet valves have captive seals to minimize seal washout
- Steel material with standard nitrile seals
- Standard end configurations include female pipe, straight thread ORB, and British pipe
- Alternative seal materials available

Applications:

- Industrial hydraulic lines
- Mobile equipment

Specifications

Body Size	1/4	1/2	3/4
Rated Pressure (PSI)	6,000	6,000	4,500
Rated Flow (GPM)	3	12	28
Temperature Range (Nitrile Seals)	-40° to +250°F		

Performance

SM Series (1/4")
Test Fluid: Oil - 200 SUS

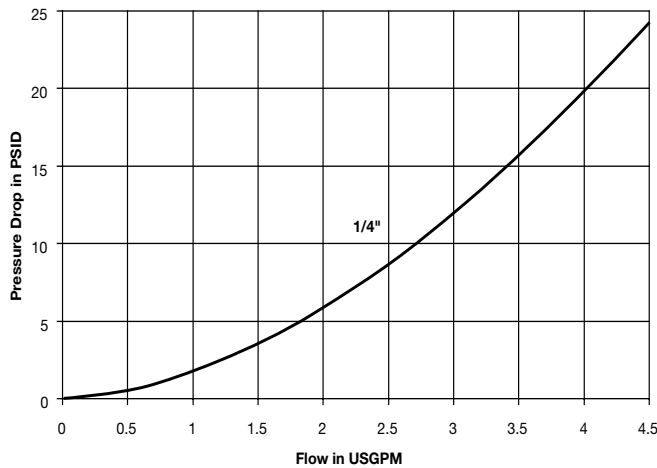

SM Series (1/2" & 3/4")
Test Fluid: Oil - 200 SUS

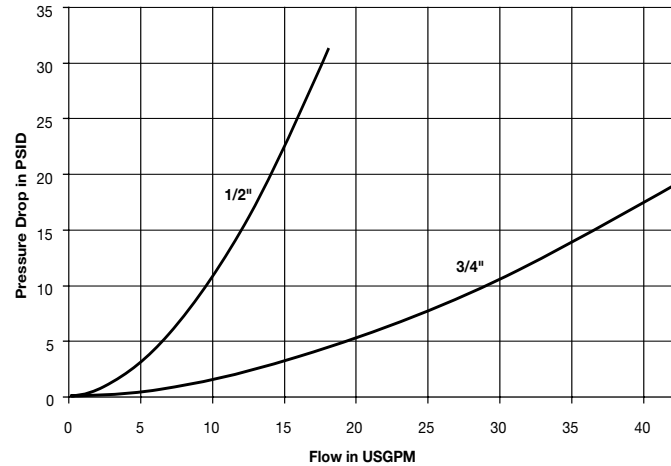

Optional Materials and Features:

(add code to part number)

Code	Description	Part Number Example
suffix -SL	Sleeve-Lok (Couplers)	SM-501-8FP-SL
suffix -E5	Ethylene Propylene seal material (EPR)	SM-501-8FP-E5
suffix -E4	Fluorocarbon seal material	SM-501-8FP-E4
suffix -E12	Neoprene seal material	SM-501-8FP-E12

Contact QCD for availability and additional options.
To select proper seal materials, see Fluid Compatibility Chart or contact QCD.





Couplers - Female Thread



Body Size	Part Number Steel	Thread Size	Length	Largest Diameter	Wrench Flats	Weight (lbs.)
1/4	SM-251-4FP	1/4-18 NPTF	2.09	1.06	0.75	0.24
1/4	SM-251-4FB	G1/4 BSPP	2.24	1.06	0.75	0.26
1/4	SM-251-6FP	3/8-18 NPTF	2.24	1.06	0.94	0.28
1/4	SM-251-6FB	G3/8 BSPP	2.24	1.06	0.94	0.26
1/4	SM-251-6FO	9/16-18 ORB	2.24	1.06	0.75	0.25
1/2	SM-501-8FP	1/2-14 NPTF	3.00	1.56	1.25	0.70
1/2	SM-501-8FB	G1/2 BSPP	3.00	1.56	1.25	0.74
1/2	SM-501-8FO	3/4-16 ORB	3.16	1.56	1.25	0.70
1/2	SM-501-12FP	3/4-14 NPTF	3.07	1.56	1.37	0.81
1/2	SM-501-12FB	G3/4 BSPP	3.16	1.56	1.37	0.85
3/4	SM-751-12FO	1 1/16-12 ORB	3.89	2.22	1.62	1.78
3/4	SM-751-12FP	3/4-14 NPTF	3.77	2.22	1.62	1.83
3/4	SM-751-12FB	G3/4 BSPP	3.89	2.22	1.62	1.88
3/4	SM-751-16FP	1-11 1/2 NPTF	3.98	2.22	1.62	1.84
3/4	SM-751-16FB	G 1 BSPP	3.98	2.22	1.62	1.89
3/4	SM-751-16FO	1-5/16 - 12 ORB	3.98	2.22	1.62	1.89

Nipple - Female Thread



Body Size	Part Number Steel	Thread Size	Length	Exposed* Length	Largest Diameter	Wrench Flats	Weight (lbs.)
1/4	SM-252-4FP	1/4-18 NPTF	1.49	0.50	0.87	0.75	0.08
1/4	SM-252-4FB	G1/4 BSPP	1.64	0.65	0.87	0.75	0.09
1/4	SM-252-6FP	3/8-18 NPTF	1.64	0.81	1.08	0.94	0.14
1/4	SM-252-6FB	G3/8 BSPP	1.64	0.81	1.08	0.94	0.14
1/4	SM-252-6FO	9/16-18 ORB	1.64	0.55	0.87	0.75	0.08
1/2	SM-502-8FO	3/4-16 ORB	2.14	0.72	1.23	1.06	0.16
1/2	SM-502-8FP	1/2-14 NPTF	2.01	0.45	1.23	1.06	0.15
1/2	SM-502-8FB	G1/2 BSPP	2.01	0.60	1.23	1.06	0.18
1/2	SM-502-12FP	3/4-14 NPTF	2.31	0.90	1.59	1.37	0.30
1/2	SM-502-12FB	G3/4 BSPP	2.63	1.07	1.59	1.37	0.34
3/4	SM-752-12FO	1 1/16-12 ORB	2.60	0.39	1.73	1.50	0.48
3/4	SM-752-12FP	3/4-14 NPTF	2.48	0.39	1.73	1.50	0.52
3/4	SM-752-12FB	G3/4 BSPP	2.60	0.53	1.73	1.50	0.56
3/4	SM-752-16FP	1-11 1/2 NPTF	2.69	0.67	1.88	1.62	0.56
3/4	SM-752-16FB	G 1 BSPP	2.69	0.67	1.88	1.62	0.68
3/4	SM-752-16FO	1-5/16 - 12 ORB	2.69	0.67	1.88	1.62	0.68

* This dimension represents the portion that is exposed when the nipple is inserted into the mating Parker Coupler.



SM Series Dust Caps and Plugs



Body Size	Nipple Dust Cap	Color/Material	Coupler Dust Plug
1/4	N/A	Plastic	PL-25
1/4	CR-25	Black Rubber	PR-25
1/4	C-25	Aluminum	P-25
1/2	DC-50	Black Rubber	DP-50
1/2	C-50	Aluminum	P-50
3/4	C-75	Aluminum	P-75



HP Series double shut-off couplings are designed for pressures up to 5000 psi. Couplers and nipples are steel with nitrile seals and are available in 1 and 1-1/2 inch sizes.

Features:

- Rated pressures up to 5000 psi
- Smooth flow path with minimal pressure drop
- Heat treated steel nipple and heavy duty sleeve withstand pressure surges
- Couplings have protective zinc with clear trivalent chromate finish
- Standard end configurations include female pipe and straight thread ORB
- Alternative seal materials available

Applications:

- Industrial hydraulic lines
- Mobile equipment

Performance

HP Series (1" & 1-1/2")
Test Fluid: Oil - 200 SUS

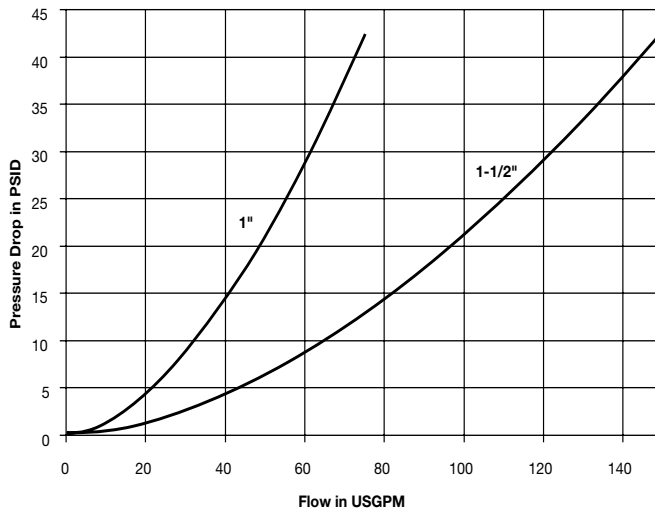

Specifications

Body Size	1	1 - 1/2
Rated Pressure (PSI)	5,000	
Rated Flow (GPM)	50	100
Temperature Range (std seals)	-40° to +250°F	

Optional Seal Materials:

(add code to part number)

Code	Description	Part Number Example
suffix -E5	Ethylene Propylene seal material (EPR)	HP-1001-16FP-E5
suffix -E4	Fluorocarbon seal material	HP-1001-16FP-E4
suffix -E12	Neoprene seal material	HP-1001-16FP-E12

Contact QCD for availability and additional options.

To select proper seal materials, see Fluid Compatibility Chart or contact QCD.



Couplers



Body Size	Part Number	Thread Size	Length	Largest Diameter	Wrench Flats	Weight (lbs.)
1	HP-1001-16FP	1 11-1/2 NPSF	3.95	2.38	1.62	2.10
1	HP-1001-16FO	1 5/16-12 ORB	4.35	2.38	1.62	2.10
1-1/2	HP-1501-24FP	1 1/2-11 1/2 NPTF	4.93	3.00	2.25	4.40
1-1/2	HP-1501-24FO	1 7/8 -12 ORB	4.93	3.00	2.25	4.40

Nipples



Body Size	Part Number	Thread Size	Overall Length	Exposed* Length	Largest Diameter	Wrench Flats	Weight (lbs.)
1	HP-1002-16FP	1 11-1/2 NPSF	3.00	1.32	1.88	1.62	0.84
1	HP-1002-16FO	1 5/16-12 ORB	3.40	1.72	1.88	1.62	0.84
1-1/2	HP-1502-24FP	1 1/2-11 1/2 NPTF	4.06	0.99	2.63	2.25	1.85
1-1/2	HP-1502-24FO	1 7/8-12 ORB	4.06	0.99	2.63	2.25	1.85

* This dimension represents the portion that is exposed when the nipple is inserted into the mating Parker Coupler.

Dust Plugs and Caps



Protective Plugs for Coupler			Protective Caps for Nipple		
P/N	Material	Fits Coupler	P/N	Material	Fits Nipple
HPP-100	Aluminum	HP-1001	HPC-100	Aluminum	HP-1002
HPP-150	Aluminum	HP-1501	HPC-150	Aluminum	HP-1502

Hydraulic Quick Couplings

General Purpose

4000 Series
Accepts ISO 5675 Nipples (1/2" size)
 Manual sleeve, poppet/ball valve



The 4000 Series brings to the industry a proven design for use on agricultural machinery and other rugged applications.

Features:

- 1/2" size accepts ISO 5675 universal tips
- Basic operation where coupler sleeve is manually retracted to allow connection with male tip
- Critical parts are hardened
- Ball and poppet valve options
- Protective zinc plating with clear trivalent chromate finish

Applications include:

- Hydraulic Loaders
- Add-on hydraulic circuits
- Hydraulic tools

B Hydraulics

4000 Series Specifications:						
Body Size	Rated Flow (gpm)	Rated Pressure (psi)	Temperature	Body Material	Sleeve Type	Seal Material
1/4	3	3000	-40° F to +250° F	Steel	Manual Connect	Nitrile
3/8	6					
1/2	12					
3/4	28					
1	50					

Performance:

4000 Series (1/4", 3/8", 1/2")
 Test Fluid: Oil - 200 SUS

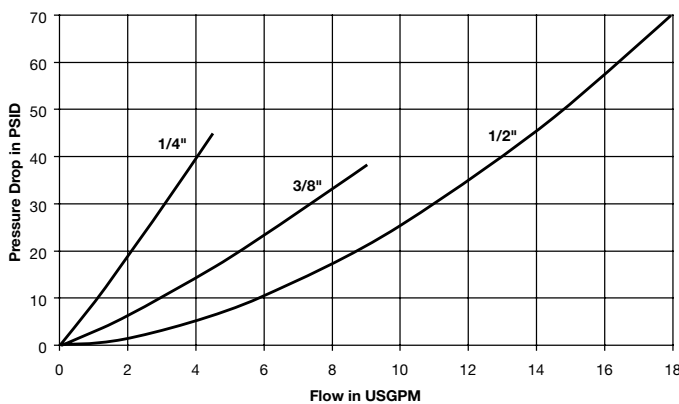

4000 Series (3/4" & 1")
 Test Fluid: Oil - 200 SUS

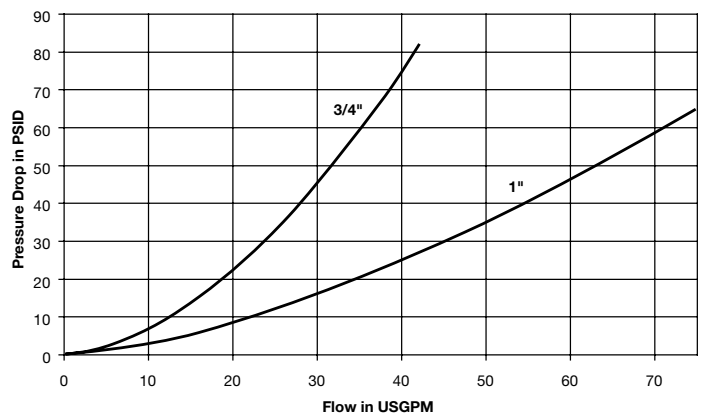

Optional Seal Materials:

(add code to part number)

Code	Description	Part Number Example
suffix W	Ethylene Propylene seal material- EPR	4050-4PW
suffix Y	Fluorocarbon seal material	4050-4PY
suffix Z	Neoprene seal material	4050-4PZ

Contact QCD for availability and additional options.
 To select proper seal materials, see Fluid Compatibility Chart or contact QCD.





4000 Series Couplers



Body Size	Coupler Part Number	Port End	Valve Type	Length	Largest Diameter	Wrench Flats	Weight (lbs.)
1/4	4050-2P	1/4-18 NPTF	Poppet	2.18	1.06	0.88	0.24
1/4	4050-2P-T8M	3/4-16 ORB (Male)	Poppet	1.80	1.06	0.88	0.21
1/4	4050-T6	9/16-18 ORB	Poppet	2.18	1.06	0.88	0.27
1/4	4050P-T6*	9/16-18 ORB	Poppet	2.43	1.33	0.88	0.33
3/8	4050-3P	3/8-18 NPTF	Poppet	2.31	1.33	0.94	0.51
1/2	4050-4	1/2-14 NPTF	Ball	2.60	1.50	1.06	0.58
1/2	4050-4P	1/2-14 NPTF	Poppet	2.60	1.50	1.06	0.58
1/2	4050-5	3/4-14 NPTF	Ball	2.69	1.50	1.13	0.71
1/2	4050-5P	3/4-14 NPTF	Poppet	2.69	1.50	1.13	0.71
1/2	4050-15	3/4-16 ORB	Ball	2.81	1.50	1.06	0.64
1/2	4050-15P	3/4-16 ORB	Poppet	2.81	1.50	1.06	0.64
1/2	4050-16	7/8-14 ORB	Ball	2.75	1.50	1.06	0.59
1/2	4050-16P	7/8-14 ORB	Poppet	2.75	1.50	1.06	0.59
1/2	4050-29BSPP	1/2-14 BSPP	Ball	2.68	1.50	1.06	0.59
3/4	4150-5	3/4-14 NPTF	Ball	3.06	1.87	1.38	1.00
1	4050-6P	1-11 1/2 NPTF	Poppet	3.84	2.08	1.63	1.89

* Special Push/Pull Sleeve

8010 Series Nipples



Body Size	Nipple Part Number	Port End	Valve Type	Length	Exposed Length*	Largest Diameter	Wrench Flats	Weight (lbs.)
1/4	4010-2P	1/4-18 NPTF	Poppet	1.48	0.71	0.87	0.75	0.08
1/4	4010-T6	9/16-18 ORB	Poppet	1.60	0.81	0.87	0.75	0.09
3/8	4010-3P	3/8-18 NPTF	Poppet	1.60	0.80	1.08	0.94	0.16
1/2	8010-4	1/2-14 NPTF	Ball	1.95	1.09	1.23	1.06	0.20
1/2	8010-4P	1/2-14 NPTF	Poppet	1.95	1.09	1.23	1.06	0.20
1/2	8010-5	3/4-14 NPTF	Ball	2.14	1.28	1.44	1.25	0.25
1/2	8010-5P	3/4-14 NPTF	Poppet	2.14	1.28	1.44	1.25	0.25
1/2	8010-15	3/4-16 ORB	Ball	1.95	1.20	1.23	1.06	0.20
1/2	8010-15P	3/4-16 ORB	Poppet	1.95	1.20	1.23	1.06	0.20
1/2	8010-16	7/8-14 ORB	Ball	1.95	1.18	1.23	1.06	0.25
1/2	8010-16P	7/8-14 ORB	Poppet	1.95	1.18	1.23	1.06	0.25
1/2	8010-29BSPP	1/2-14 BSPP	Ball	1.95	1.09	1.18	1.06	0.25
3/4	4110-5	3/4-14 NPTF	Ball	1.81	1.23	1.52	1.31	0.50
1	4010-6P	1-11 1/2 NPTF	Poppet	2.79	1.49	1.88	1.63	0.62

* This dimension represents the portion of the nipple that is exposed when the nipple and coupler are connected.

B Hydraulics



4050 Series Replacement O-Rings			
Body Size	Material	Part Number	Durometer
1/4	Nitrile	50001-113-0260	90
3/8	Nitrile	50001-116-0260	90
1/2	Nitrile	50001-211-0260	90
3/4	Nitrile	50001-215-0010	70
1	Nitrile	50001-218-0260	90

4000 Series Dust Caps and Plugs				
Body Size	Dust Plug (Coupler)	Color/Material	Dust Cap (Nipple)	Weight (lbs.)
1/4	5205-2M	Black Rubber	5209-2M	.02
3/8	5205-3M	Black Rubber	5209-3M	.03
1/2	5205-4M	Black Rubber	5209-4M	.04
1/2	5005-4	Steel w/Chain	5009-4	.21
1/2	5205-4M-BU	Blue Rubber	5209-4M-BU	.04
1/2	5205-4M-GR	Green Rubber	5209-4M-GR	.04
1/2	5205-4M-RE	Red Rubber	5209-4M-RE	.04
1/2	5205-4M-YE	Yellow Rubber	5209-4M-YE	.04
3/4	5205-5M	Black Rubber	5209-5M	.05
1	5205-6M	Black Rubber	5209-6M	.06

Hydraulic Quick Couplings

General Purpose

4200 Series
Accepts ISO 5675 Nipples (1/2" size)
 Push/pull/breakaway sleeve



The 4200 Series brings to the industry a proven design for use on agricultural machinery, construction equipment, and other rugged applications where a breakaway feature is desirable.

Features:

- 1/2" size accepts ISO 5675 universal tips
- Grooves in sleeve to accommodate retaining rings for bulkhead mounting
- One-handed push-to-connect operation when coupler is clamp mounted
- 1/2" body size couplers are compatible with 5001-4 and 5006-4 breakaway clamps
- Critical parts are hardened
- Ball and poppet valve options
- Protective zinc plating with clear trivalent chromate finish

Applications include:

- Hydraulic Loaders
- Add-on hydraulic circuits
- Implement breakaway
- Hydraulic tools

B Hydraulics



4200 Series Specifications:

Body Size	Rated Flow (gpm)	Rated Pressure (psi)	Temperature	Body Material	Sleeve Type	Seal Material
3/8	6	3000	-40° F to +250° F	Steel	Push/pull/breakaway	Nitrile
1/2	12					

Performance:

4200 Series (3/8" & 1/2")
 Test Fluid: Oil - 200 SUS

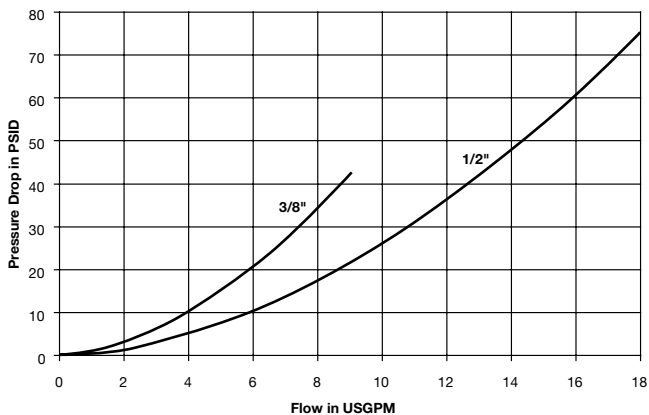

4200 Series Dust Caps and Plugs



Body Size	Dust Plug (Coupler)	Color/Material	Dust Cap (Nipple)	Weight (lbs.)
3/8	5205-3M	Black Rubber	5209-3M	.03
1/2	5205-4M	Black Rubber	5209-4M	.04
1/2	5005-4	Steel w/Chain	5009-4	.21
1/2	5205-4M-BU	Blue Rubber	5209-4M-BU	.04
1/2	5205-4M-GR	Green Rubber	5209-4M-GR	.04
1/2	5205-4M-RE	Red Rubber	5209-4M-RE	.04
1/2	5205-4M-YE	Yellow Rubber	5209-4M-YE	.04

Optional Seal Materials:

(add code to part number)

Code	Description	Part Number Example
suffix W	Ethylene Propylene seal material- EPR	4250-4PW
suffix Y	Fluorocarbon seal material	4250-4PY
suffix Z	Neoprene seal material	4250-4PZ

Contact QCD for availability and additional options.
 To select proper seal materials, see Fluid Compatibility Chart or contact QCD.





4200 Series Couplers



Body Size	Coupler Part Number	Port End	Valve Type	Length	Largest Diameter	Wrench Flats	Weight (lbs.)
3/8	4250-3P	3/8-18 NPTF	Poppet	2.31	1.31	0.81	0.39
1/2	4250-4	1/2-14 NPTF	Ball	2.68	1.50	0.94	0.55
1/2	4250-4P	1/2-14 NPTF	Poppet	2.68	1.50	0.94	0.55
1/2	4250-15	3/4-16 ORB	Ball	2.68	1.50	0.94	0.55
1/2	4250-15P	3/4-16 ORB	Poppet	2.68	1.50	0.94	0.55

8010 Series Nipples



Body Size	Nipple Part Number	Port End	Valve Type	Length	Exposed Length*	Largest Diameter	Wrench Flats	Weight (lbs.)
3/8	4010-3P	3/8-18 NPTF	Poppet	1.60	0.80	1.08	0.94	0.16
1/2	8010-4	1/2-14 NPTF	Ball	1.95	1.09	1.23	1.06	0.20
1/2	8010-4P	1/2-14 NPTF	Poppet	1.95	1.09	1.23	1.06	0.20
1/2	8010-15	3/4-16 ORB	Ball	2.06	1.20	1.23	1.06	0.20
1/2	8010-15P	3/4-16 ORB	Poppet	2.06	1.20	1.23	1.06	0.20

* This dimension represents the portion of the nipple that is exposed when the nipple and coupler are connected.

8010 Series Nipples (Connect Under Pressure)



Body Size	Nipple Part Number	Port End	Valve Type	Length	Exposed Length*	Largest Diameter	Wrench Flats	Weight (lbs.)
1/2	8010-4P-DC	1/2-14 NPTF	DC Poppet	1.81	1.09	1.06	1.16	0.20
1/2	8010-15P-DC	1/2-14 NPTF	DC Poppet	1.81	1.09	1.06	1.16	0.20

4250 Series Replacement O-Rings

Body Size	Material	Part Number	Durometer
3/8	Nitrile	50001-116-0260	90
1/2	Nitrile	50001-211-0260	90



NS Series non-spill couplings are designed to minimize spillage and air inclusion when connecting or disconnecting. Couplers and nipples are steel with nitrile seals. 1/2 inch through 1 inch sizes utilize a PTFE back-up ring as additional support to the interface seal.

Features:

- Rated pressure up to 2500 psi
- Positive valve stop prevents flow checking
- Heat treated steel nipple and heavy duty sleeve withstand pressure surges
- Standard sleeve lock guards against accidental disconnection
- Couplings have protective zinc with clear trivalent chromate finish
- Standard end configurations include female pipe, straight thread ORB, and BSPP
- Alternative seal materials available

Applications:

- Hydraulic hand tools
- Utility equipment
- Mining equipment

Performance

NS Series (3/8" & 1/2")
Test Fluid: Oil - 200 SUS

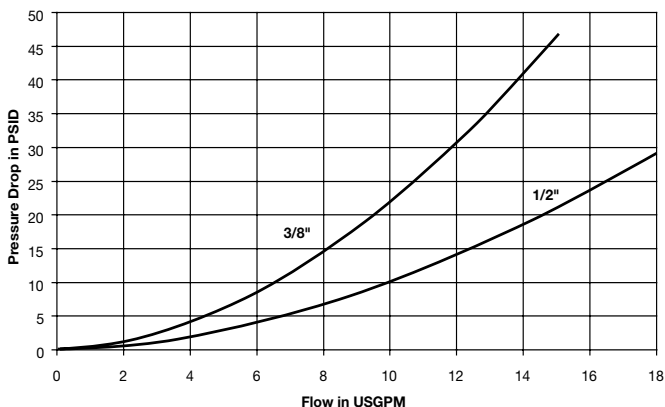

NS Series (3/4" & 1")
Test Fluid: Oil - 200 SUS

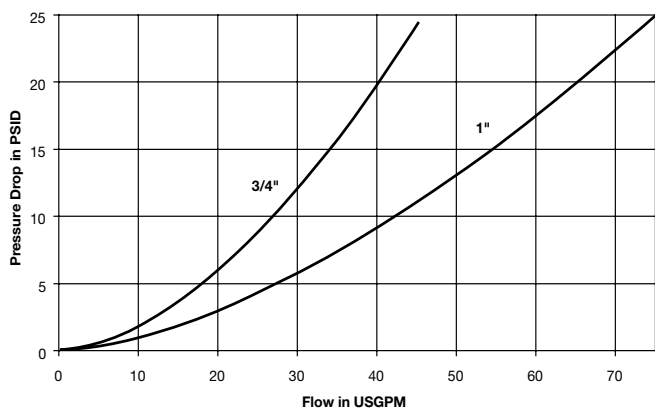

Specifications

Body Size	3/8	1/2	3/4	1
Rated Pressure (psi)	2,500			
Rated Flow (gpm)	10	12	30	50
Temperature Range (std seals)	-40° to +250°F			
Spillage (ml) (max. per disconnect)	0.020	0.070	0.150	0.220
Air Inclusion (ml) (max. per disconnect)	0.010	0.020	0.050	0.070

NS Series Dust Plug/Caps



Body Size	Dust Plug/Cap Rubber
3/8	NR-37
1/2	NR-50
3/4	NR-75
1	NR-100



Couplers



Body Size	Part Number Steel	Thread Size	Length	Largest Diameter	Wrench Flats	Weight (lbs.)
3/8	NS-371-6FP	3/8-18 NPSF	2.10	1.13	1.06	0.36
3/8	NS-371-6FB	G3/8 BSPP	2.10	1.13	1.06	0.38
3/8	NS-371-8FO	3/4-16UNF	2.20	1.13	1.06	0.40
1/2	NS-501-8FP	1/2-14 NPSF	2.88	1.56	1.25	0.84
1/2	NS-501-8FB	G1/2 BSPP	2.95	1.56	1.25	0.74
1/2	NS-501-10FO	7/8-14UNF	2.97	1.56	1.25	0.80
3/4	NS-751-12FP	3/4-14 NPSF	3.19	1.96	1.56	1.48
3/4	NS-751-12FB	G3/4 BSPP	3.38	1.96	1.56	1.54
3/4	NS-751-12FO	1 1/16-12UN	3.51	1.96	1.56	1.58
1	NS-1001-16FP	1-11 1/2 NPSF	3.70	2.25	1.75	2.35
1	NS-1001-16FB	G 1 BSPP	3.81	2.25	1.75	2.36
1	NS-1001-16FO	1 5/16-12UN	3.81	2.25	1.75	2.36

Nipples



Body Size	Part Number Steel	Thread Size	Overall Length	Exposed* Length	Largest Diameter	Wrench Flats	Weight (lbs.)
3/8	NS-372-6FP	3/8-18 NPSF	1.70	1.17	1.08	0.94	0.16
3/8	NS-372-6FB	G3/8 BSPP	1.78	1.25	1.08	0.94	0.16
3/8	NS-372-8FO	3/4-16UNF	1.91	1.38	1.23	1.06	0.20
1/2	NS-502-8FP	1/2-14 NPSF	1.81	0.69	1.23	1.06	0.20
1/2	NS-502-8FB	G1/2 BSPP	1.95	0.83	1.23	1.06	0.22
1/2	NS-502-10FO	7/8-14UNF	2.14	1.02	1.23	1.06	0.23
3/4	NS-752-12FP	3/4-14 NPSF	2.25	1.12	1.59	1.37	0.48
3/4	NS-752-12FB	G3/4 BSPP	2.47	1.34	1.59	1.37	0.54
3/4	NS-752-12FO	1 1/16-12UN	2.62	1.49	1.59	1.37	0.65
1	NS-1002-16FP	1-11 1/2 NPSF	2.64	1.54	1.88	1.62	0.72
1	NS-1002-16FB	G 1 BSPP	2.78	1.68	1.88	1.62	0.74
1	NS-1002-16FO	1 5/16-12UN	2.78	1.68	1.88	1.62	0.80

* This dimension represents the portion that is exposed when the nipple is inserted into the mating Parker Coupler.

Standard Port Configurations

FP - Female Pipe Thread

FO - Female Straight Thread

FB - Female British Standard Parallel Pipe

Optional Seal Materials:

(add code to part number)

Code	Description	Part Number Example
suffix -E5	Ethylene Propylene seal material (EPR)	NS-502-8FP-E5
suffix -E4	Fluorocarbon seal material	NS-502-8FP-E4

Contact QCD for availability and additional options.

To select proper seal materials, see Fluid Compatibility Chart or contact QCD.



Parker Non-Spill Adapters were designed to accommodate the widespread use of several coupling types in mobile equipment. These adapters allow the user to adapt between poppet style, (ISO 7241-A), 6600 series couplings and non-spill type, (ISO 16028), FEM series couplings. They are useful where multiple hydraulic attachments are being utilized.

Features:

- Adapts flush, non-spill valving to / from poppet style
- Global interchangeability with other ISO 16028 and ISO 7241-A compliant couplings
- Protective zinc plating with clear trivalent chromate finish

Applications include:

- Skid loader attachments

Performance

FEM/FF to 6600 Adapter (1/2")
Test Fluid: Oil - 200 SUS

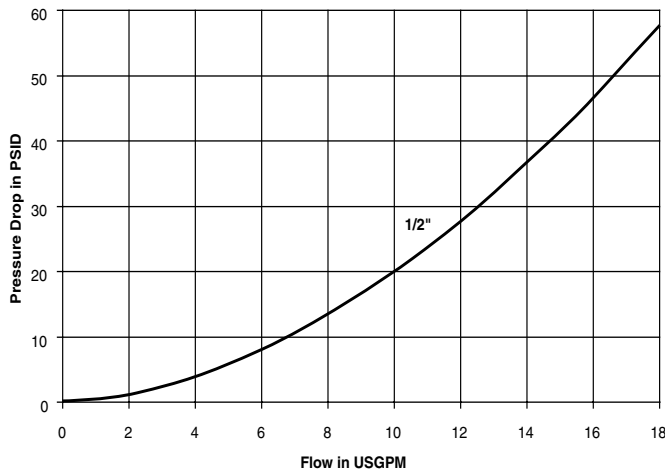

How To Order

Adapter Part Number

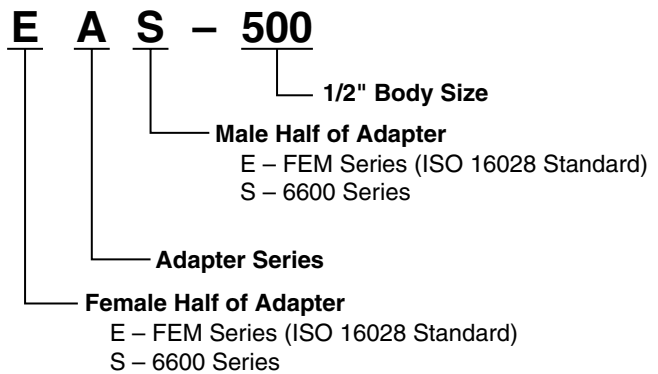

Specifications

Body Size	Rate Pressure (psi)	Rated Flow (gpm)	Temperature Range	Flush Face End Spillage (ml) max. per disconnect	Flush Face End Air Inclusion (ml) max. per connect
1/2	3625	12	-40° to +250° F	.020	.070

Adapters



Body Size	Part Number	Thread Size	Length	Wrench Flats	Largest Diameter
1/2	EAS-500	N/A	3.36	1.38	1.50
1/2	SAE-500	N/A	3.00	1.25	1.48

Hydraulic Quick Couplings Non-Spill

FF/FC Series HTMA (3/8 size) Push to connect/sleeve lock



FF Series couplings eliminate spillage and air inclusion when connecting and disconnecting. The sleeve locking mechanism prevents accidental disconnection. 3/8" body size complies with Hydraulic Tool Manufacturers Association standards. FC nipples provide a connect-under-pressure option for trapped pressures up to 3000 psi on the nipple side.

Features

- Flush, non-spill valving
- Hardened steel sleeves and nipple bodies
- Locking sleeve
- Blow-out resistant seal
- Connect-under-pressure FC nipple option
- Protective zinc plating with clear trivalent chromate finish

Applications include:

- Hydraulic tools
- Mobile equipment
- Industrial hydraulics

Performance

FF Series (1/4", 3/8", 1/2")
Test Fluid: Oil - 200 SUS

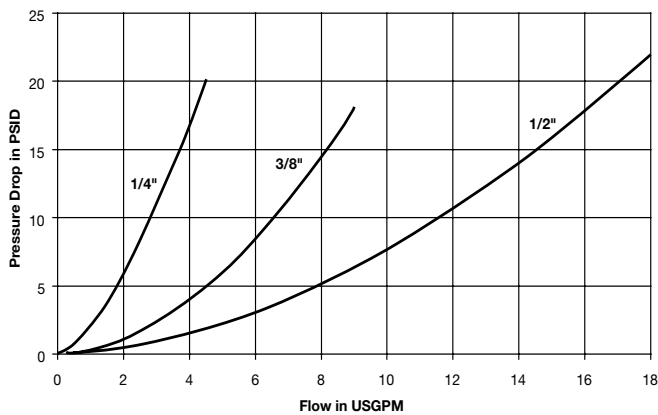

FF Series (3/4" & 1")
Test Fluid: Oil - 200 SUS

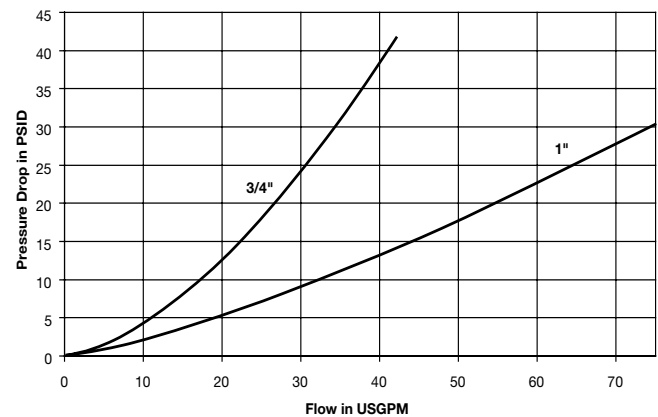

FF Series Specifications

Body Size	Rated Pressure (psi)	Rated Flow (gpm)	Temperature Range	Spillage (ml) max. per disconnect	Air Inclusion (ml) max. per connect	Body Material	Sleeve Type	Seal Material
1/4	5000	3	-40° to +250°F	.015	.020	Steel	Push to Connect	Nitrile/ Polyurethane
3/8	3000	6		.015	.020			
1/2	3000	12		.080	.070			
3/4	3000	28		.150	.100			
1	3000	50		.200	.150			



FF Series Couplers



Body Size	Coupler Part Number	Port End	Length	Largest Diameter	Wrench Flats	Weight (lbs.)
1/4	FF-251-4FP	1/4-18 NPSF	1.79	1.06	1.00	0.23
1/4	FF-251-4MP	1/4-18 NPTF	1.84	1.06	1.00	0.24
1/4	FF-251-6FO	9/16-18 UNF	1.91	1.06	1.00	0.23
3/8	FF-371-6FP	3/8-18 NPSF	2.39	1.20	1.06	0.44
3/8	FF-371-8FP	1/2-14 NPSF	2.80	1.20	1.06	0.50
3/8	FF-371-6FB	G3/8 BSPP	2.45	1.20	1.06	0.45
3/8	FF-371-8FB	G1/2 BSPP	2.80	1.20	1.06	0.48
3/8	FF-371-8FO	3/4-16 UNF	2.82	1.20	1.06	0.52
1/2	FF-501-8FP	1/2-14 NPSF	3.00	1.54	1.25	0.88
1/2	FF-501-10FO	7/8-14 UNF	3.00	1.54	1.25	1.05
3/4	FF-751-12FP	3/4-14 NPSF	3.50	1.94	1.75	1.84
3/4	FF-751-12FO	1 1/16-12 UNF	3.75	1.94	1.75	1.93
1	FF-1001-16FP	1-11 1/2 NPSF	4.14	2.25	1.87	2.64
1	FF-1001-16FO	1 5/16-12UNF	4.24	2.25	1.87	2.68

FF Series Nipples



Body Size	Nipple Part Number	Port End	Length	Exposed Length*	Largest Diameter	Wrench Flats	Weight (lbs.)
1/4	FF-252-4FP	1/4-18 NPSF	1.66	1.15	1.06	1.00	0.16
1/4	FF-252-4MP	1/4-18 NPTF	1.72	1.18	1.06	1.00	0.26
1/4	FF-252-6FO	9/16-18 UNF	1.66	1.15	1.06	1.00	0.16
3/8	FF-372-6FP	3/8-18 NPSF	2.31	1.71	1.08	0.94	0.26
3/8	FF-372-8FP	1/2-14 NPSF	2.64	2.04	1.19	1.06	0.32
3/8	FF-372-6FB	G3/8 BSPP	2.45	1.86	1.08	0.94	0.28
3/8	FF-372-8FB	G1/2 BSPP	2.70	2.16	1.19	1.06	0.32
3/8	FF-372-8FO	3/4-16 UNF	2.70	2.16	1.19	1.06	0.3
1/2	FF-502-8FP	1/2-14 NPSF	2.75	2.11	1.38	1.25	0.42
1/2	FF-502-10FO	7/8-14 UNF	2.75	2.07	1.38	1.25	0.44
3/4	FF-752-12FP	3/4-14 NPSF	3.38	2.47	1.73	1.50	1.00
3/4	FF-752-12FO	1 1/16-12 UNF	3.58	2.47	1.73	1.50	1.02
1	FF-1002-16FP	1-11 1/2 NPSF	3.85	2.60	2.17	1.87	1.60
1	FF-1002-16FO	1 5/16-12UNF	3.85	2.60	2.17	1.87	1.70

Standard Port Configurations: **FP** - Female Pipe Thread **FO** - Female Straight Thread
MP - Male Pipe Thread **FB** - Female British Standard Pipe Parallel

* This dimension represents the portion of the nipple that is exposed when the nipple and coupler are connected.



Optional Seal Materials: (add code to part number)

Code	Description	Part Number Example
suffix -E5	Ethylene Propylene seal material (EPR)	FF-501-8FP-E5
suffix -E4	Fluorocarbon seal material	FF-501-8FP-E4

Optional seals include O-ring & Back-Up Ring, not Anti-Blow Out bonded seal. Contact QCD for availability and additional options. To select proper seal materials, see Fluid Compatibility Chart or contact QCD.

FF Series Repair Kits				Spline Tool
1/4" Nipple	FF-252-KIT	FF-252-KIT-E4	FF-252-KIT-E5	-
1/4" Coupler	FF-251-KIT	FF-251-KIT-E4	FF-251-KIT-E5	FF/FS-251-TOOL
3/8" Nipple	FF-372-KIT	FF-372-KIT-E4	FF-372-KIT-E5	-
3/8" Coupler	FF-371-KIT	FF-371-KIT-E4	FF-371-KIT-E5	FF/FS-371-TOOL
3/4" Nipple	FF-752-KIT	FF-752-KIT-E4	FF-752-KIT-E5	-
3/4" Coupler	FF-751-KIT	FF-751-KIT-E4	FF-751-KIT-E5	FF/FS-751-TOOL
1" Nipple	FF-1002-KIT	FF-1002-KIT-E4	FF-1002-KIT-E5	-
1" Coupler	FF-1001-KIT	FF-1001-KIT-E4	FF-1001-KIT-E5	FF/FS-1001-TOOL

Dust Caps - FF Series			
	Body Size	Coupler Dust Cap - Rubber	Nipple Dust Cap - Rubber
	1/4	FR-25	FR-25
	3/8	NR-50	NR-37
	1/2	FR-501	FR-502
	3/4	FR-751	FR-752
	1	FR-1001	FR-1002



Connect Under Pressure Operation

FC Series products operate slightly different from traditional non-spill couplings. With no pressure in the coupler and up to 3000 PSI of trapped pressure in the nipple, begin to couple the mating halves. Delay momentarily during connection to allow trapped pressure to equalize with the mating half before completing the connection.

FC Series nipples provide a connect-under-pressure option for trapped pressures up to 3000 psi on the nipple side.

Features:

- Connect-under-pressure nipple
- Flush, non-spill valving
- Hardened locking surface
- Blow-out resistant seal
- Protective zinc plating with clear trivalent chromate finish

Applications include:

- Hydraulic tools

FC Series Specifications

Body Size	Rated Pressure (psi)	Rated Connect-Under-Pressure Capability	Rated Flow (gpm)	Spillage (ml) max. per disconnect	Air Inclusion (ml) max. per connect
3/8	3000	3000	6	.015	.020
1/2	3000	3000	12	.020	.070
3/4	3000	1500	26	.150	.100

Performance

FC Series (3/8", 1/2", 3/4")
Test Fluid: Oil - 200 SUS

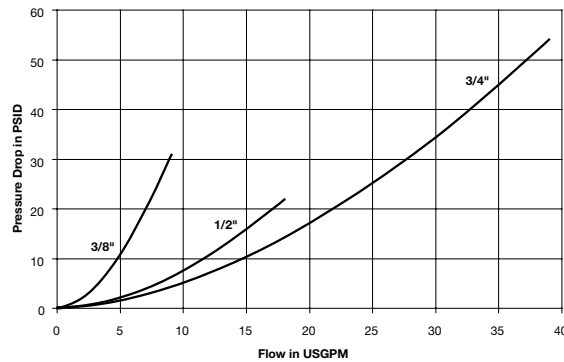

FC Series Connect Under Pressure Nipples



Body Size	Part Number	Mating Half	Port End	Length	Exposed Length*	Largest Diameter	Wrench Flats	Weight (lbs.)
3/8	FC-372-6FP	FF-371	3/8-18 NPSF	3.30	2.58	1.16	1.062	0.45
3/8	FC-372-8FO	FF-371	3/4-16 UNF	3.30	2.58	1.16	1.062	0.42
3/8	FC-372-8FP	FF-371	1/2-14 NPSF	3.30	2.58	1.16	1.062	0.42
1/2	FC-502-8FP	FF-501	1/2-14 NPSF	3.46	2.65	1.22	1.125	0.53
1/2	FC-502-10FO	FF-501	7/8-14 UNF	3.46	2.65	1.22	1.125	0.52
3/4	FC-752-12FO	FF-751	1 1/16-12 UNF	4.81	3.72	1.65	1.500	1.32
3/4	FC-752-12FP	FF-751	3/4-14 NPSF	4.81	3.72	1.65	1.500	1.34

Standard Port Configurations: FP - Female Pipe Thread FO - Female Straight Thread

* This dimension represents the portion of the nipple that is exposed when the nipple and coupler are connected.



FEM Series couplings meet or exceed ISO 16028 design and performance requirements. The flush valves eliminate spillage and air inclusion when connecting and disconnecting. Coupler and nipple bodies have a modular design with increased flexibility for end port options. FEC nipples provide a connect-under-pressure option for trapped residual pressure.

Features

- Flush, non-spill valving
- Global interchangeability with other ISO 16028 compliant couplings
- Hardened steel sleeves and nipple bodies
- Optional locking sleeve
- Connect-under-pressure FEC nipple option
- Protective zinc plating with clear trivalent chromate finish

Applications include:

- Skid loader attachments
- Hydraulic tools

Materials of Construction

Body: Steel
Finish: Zinc with clear trivalent chromate
Valve: Flush face valving
Seal: Polyurethane and Nitrile

Performance

FEM Series (1/4", 3/8" & 1/2")
Test Fluid: Oil - 150 SUS

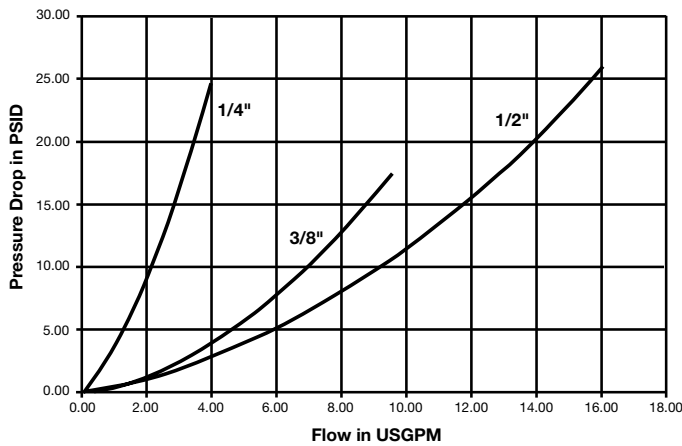

FEM Series (5/8", 3/4" & 1")
Test Fluid: Oil - 150 SUS

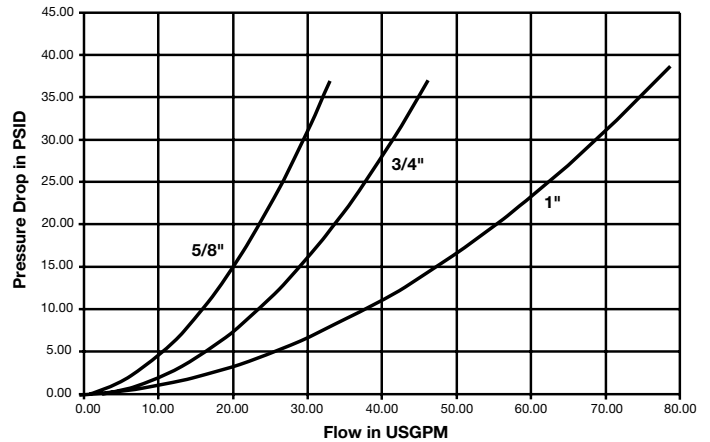

FEM Series Specifications

Body Size	Rated Pressure (psi)	Rated Flow (gpm)	Temperature Range	Spillage (ml) max. per disconnect	Air Inclusion (ml) max. per connect	Body Material	Sleeve Type	Seal Material
1/4	4568	3	-22° to +212°F	.015	.020	Steel	Push to Connect	Polyurethane and Nitrile
3/8	3625	6		.015	.020			
1/2	3625	12		.020	.070			
5/8	3625	20		.030	.070			
3/4	3625	26		.150	.100			
1	2900	50		.200	.150			



FEM Series Couplers



Body Size	Coupler Part Number	Port End	Length	Coupled Length (when connected to corresponding nipple)	Largest Diameter	Wrench Flats	Weight (lbs.)
1/4	FEM-251-4FP-NL	1/4-18 NPSF	1.96	3.98	1.16	27mm	0.52
1/4	FEM-251-6FO-NL	9/16-18 UNF	2.08	4.06	1.16	27mm	0.51
3/8	FEM-371-6FP-NL	3/8-18 NPSF	2.89	4.43	1.26	30mm	0.68
3/8	FEM-371-8FO-NL	3/4-16 UNF	2.89	4.67	1.26	30mm	0.68
1/2	FEM-501-8FP-NL	1/2-14 NPSF	2.96	5.09	1.54	1.25	0.93
1/2	FEM-501-8FO-NL	3/4-16 UNF	2.96	5.09	1.54	1.25	0.93
1/2	FEM-501-10FO-NL	7/8-14 UNF	2.96	5.09	1.54	1.25	0.93
1/2	FEM-501-12FO-NL	1 1/16-12 UNF	3.21	5.59	1.54	1.25	0.93
5/8	FEM-621-12FO-NL	1 1/16-12 UNF	3.70	5.64	1.69	40mm	1.34
3/4	FEM-751-12FP-NL	3/4-14 NPSF	3.95	6.00	1.97	46mm	1.98
3/4	FEM-751-12FO-NL	1 1/16-12 UNF	3.95	6.20	1.97	46mm	2.00
1	FEM-1001-16FP-NL	1-11 1/2-NPSF	4.21	6.79	2.36	55mm	3.08
1	FEM-1001-16FO-NL	1 5/16-12 UNF	4.21	6.79	2.36	55mm	3.03

FEM Series Couplers (Bulkhead)



Body Size	Coupler Part Number	Port End	Length	Coupled Length (when connected to corresponding nipple)	Largest Diameter	Wrench Flats	Weight (lbs.)
1/2	FEM-501-10BMF-NL	7/8-14 UNF	4.04	7.24	1.54	1.25	1.13
1/2	FEM-501-10BMS-NL	1-14 UNS	4.04	7.24	1.54	1.25	1.13

Code	Description	Part Number Example
suffix -E5	Ethylene Propylene seal material (EPR)	FEM-501-8FP-NL-E5
suffix -E4	Fluorocarbon seal material	FEM-501-8FP-NL-E4

Contact QCD for availability and additional options.
To select proper seal materials, see Fluid Compatibility Chart or contact QCD.



FEM Series Nipples



Body Size	Nipple Part Number	Port End	Length	Coupled Length (when connected to corresponding coupler)	Largest Diameter	Wrench Flats	Weight (lbs.)
1/4	FEM-252-4FP	1/4-18 NPSF	1.71	3.98	0.96	22mm	0.20
1/4	FEM-252-6FO	9/16-18 NPSF	1.95	4.06	0.96	22mm	0.19
3/8	FEM-372-6FP	3/8-18 NPSF	2.48	4.43	1.26	30mm	0.40
3/8	FEM-372-8FO	3/4-16 UNF	2.48	4.67	1.26	30mm	0.41
1/2	FEM-502-8FP	1/2-14 NPSF	2.77	5.09	1.38	1.25	0.54
1/2	FEM-502-8FO	3/4-16 UNF	2.77	5.09	1.38	1.25	0.54
1/2	FEM-502-10FO	7/8-14 UNF	2.77	5.09	1.38	1.25	0.54
1/2	FEM-502-12FO	1 1/16-12 UN	3.02	5.59	1.38	1.25	0.54
5/8	FEM-622-12FO	1 1/16-12 UN	3.09	5.64	1.57	36mm	0.72
3/4	FEM-752-12FP	3/4-14 NPSF	3.38	6.00	1.97	46mm	1.17
3/4	FEM-752-12FO	1-1/16 12 UN	3.38	6.20	1.974	46mm	1.20
1	FEM-1002-16FP	1-11 1/2 NPSF	3.85	6.79	2.36	55mm	1.94
1	FEM-1002-16FO	1-5/16 12 UN	3.85	6.79	2.36	55mm	1.90

FEM Series Nipples (Bulkhead)

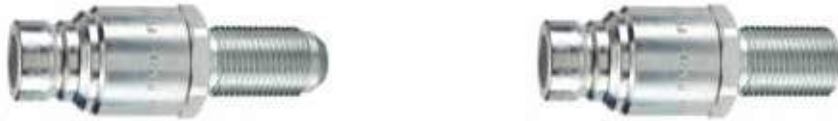

Body Size	Nipple Part Number	Port End	Length	Coupled Length (when connected to corresponding nipple)	Largest Diameter	Wrench Flats	Weight (lbs.)
1/2	FEM-502-10BMF	7/8-14 UNF	3.85	7.24	1.38	1.25	.84
1/2	FEM-502-10BMS	1-14 UNS	3.85	7.24	1.38	1.25	.84

Standard Port Configurations: **FP** - Female Pipe Thread **FO** - Female Straight Thread **BMF** - Bulkhead Flare **BMS** - Bulkhead Face Seal

Other Fitting Port Configurations available upon request.

* This dimension represents the portion of the nipple that is exposed when the nipple and coupler are connected.

Dust Caps - FEM Series

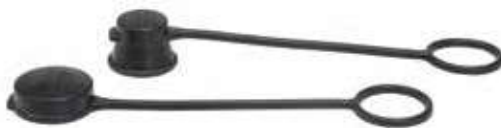

Body Size	Nipple Dust Cap	Coupler Dust Cap	Material
1/4	CFE-252-PN	PFE-251-PN	PVC
3/8	CFE-372-PN	PFE-371-PN	PVC
1/2	CFE-502-PN	PFE-501-PN	PVC
5/8	CFE-622-PN	PFE-621-PN	PVC
3/4	CFE-752-PN	PFE-751-PN	PVC
1	CFE-1002-PN	PFE-1001-PN	PVC



Applications

Parker FEC Series nipple provide connect-under-pressure capability with up to 3000 PSI of trapped pressure in the nipple and are ideal for applications where residual pressure makes reconnect difficult. Utilized primarily in the construction equipment market, FEC Series products are commonly found on hydraulic attachments used in skid steer applications. The FEC Series mates with the FEM Series interface ISO 16028 couplers.

Features:

- Connect-Under-Pressure nipple
- Hardened locking surface
- Steel construction, Chromium-6 Free plating for corrosion resistance
- Anti blowout bonded nipple seal
- Flush face valving

Connect Under Pressure Operation

FEC Series products operate slightly different from traditional non-spill couplings. With no pressure in the coupler and up to 3000 PSI of trapped pressure in the nipple, begin to couple the mating halves. Delay momentarily during connection to allow trapped pressure to equalize with the mating half before completing the connection.

Performance FEC Series (1/2", 5/8", 3/4")
Test Fluid: Oil - 200 SUS

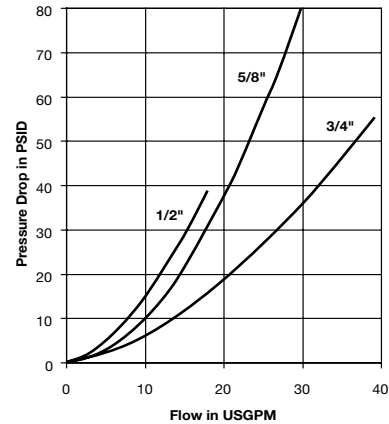

FEC Series Specifications

Body Size	Rate Pressure (psi)	Rated Connect-Under-Pressure Capability	Rated Flow (gpm)	Spillage (ml) max. per disconnect	Air Inclusion (ml) max. per connect
1/2	3625	3000	12	.020	.070
5/8	3625	1700	20	.003	.070
3/4	3625	1500	26	.150	.100

FEC Series Connect Under Pressure Nipples



Body Size	Part Number	Mating Half	Port End	Length	Coupled Length (when connected to corresponding nipple)	Largest Diameter	Wrench Flats	Weight (lbs.)
1/2	FEC-502-8FP	FEM-501	1/2-14 NPSF	3.50	5.82	1.22	1.125	-
1/2	FEC-502-10FO	FEM-501	7/8-14 UNF	3.50	5.82	1.22	1.125	-
1/2	FEC-502-12FO	FEM-501	1 1/16-12 UNF	3.79	6.36	1.65	1.500	-
5/8	FEC-622-12FO	FEM-621	1 1/16-12 UN	3.39	5.94	1.65	1.500	-
3/4	FEC-752-12FO	FEM-751	1 1/16-12 UN	3.76	6.58	1.65	1.500	-

Standard Port Configurations: FP - Female Pipe Thread FO - Female Straight Thread

* This dimension represents the portion of the nipple that is exposed when the nipple and coupler are connected.



FH Series high pressure, non-spill couplings have flush valves and are designed to minimize spillage and air inclusion when connecting or disconnecting. Couplers and nipples are steel with nitrile seals. Available in 3/8 inch size only, with red finish for easy identification. Will not connect with lower pressure flush face couplings.

Features:

- Rated pressure up to 10,000 psi
- Push to connect operation
- Red finish on nipple body and coupler sleeve
- Standard sleeve lock guards against accidental disconnection
- Not interchangeable with lower pressure flush face couplings
- Standard end configurations include female pipe, male pipe, and BSPP threads
- Alternative seal materials available

Applications:

- Hydraulic crimpers, cutters, benders, clamps, wedges
- Rescue equipment
- High pressure test equipment

Performance

FH Series (3/8")
Test Fluid: Oil - 200 SUS

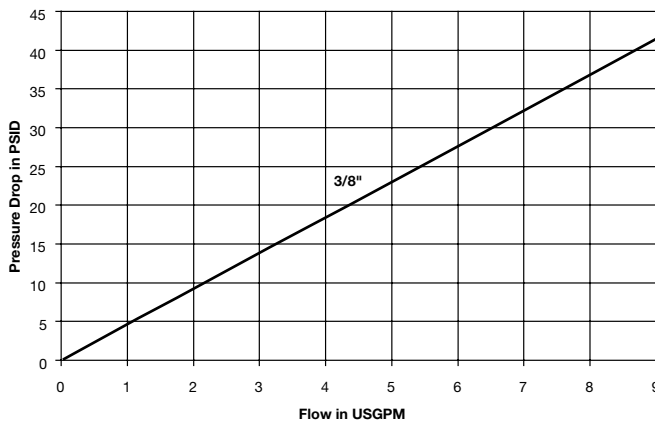

Specifications

Body Size	3/8
Rated Pressure (PSI)	10,000
Rated Flow (GPM)	6
Temperature Range	-40° to +250° F
Spillage (ML) (max. per disconnect)	.020
Air Inclusion (ML) (max. per connect)	.070

Materials of Construction

Body	Steel
Finish	Chromium-6 Free plating
Valve	Flush Face Valves
Seal	Anti blow-out Nitrile/PTFE bonded seal (nipple only)

Optional Seal Materials:

(add code to part number)

Code	Description	Part Number Example
suffix -E5	Ethylene Propylene seal material (EPR)	FH-371-6FP-E5
suffix -E4	Fluorocarbon seal material	FH-371-6FP-E4

Optional seals include O-ring & Back-Up Ring, not Anti-Blow Out bonded seal. Contact QCD for availability and additional options. To select proper seal materials, see Fluid Compatibility Chart or contact QCD.



Couplers



Body Size	Part Number Steel	Thread Size	Length	Largest Diameter	Wrench Flats	Weight (lbs.)
3/8	FH-371-6FP	3/8 -18 NPTF	2.63	1.23	1.12	0.44
3/8	FH-371-6MP	3/8 -18 NPTF	2.85	1.23	1.12	0.45
3/8	FH-371-6FB	G3/8 -BSPP	2.63	1.23	1.12	0.45

Nipples



Body Size	Part Number Steel	Thread Size	Length	Largest Diameter	Wrench Flats	Weight (lbs.)
3/8	FH-372-6FP	3/8-18 NPTF	2.12	1.23	1.00	0.26
3/8	FH-372-6FB	G3/8 -BSPP	2.12	1.23	1.00	0.28

Standard Port Configurations: **FP** - Female Pipe Thread **MP** - Male Pipe Thread **FB** - Female British Parallel Pipe

FH Series Dust Caps



Body Size	Coupler Dust Cap - Rubber	Nipple Dust Cap - Rubber
3/8	NR-50	NR-37



FS Series dry disconnect couplings are ideal for closed system transfer and dispensing of chemicals and other fluids. The flush valves eliminate spillage and air inclusion when connecting and disconnecting to result in minimal environmental contamination.

Features:

- Flush, non-spill valves enable ease of cleaning
- 316 stainless steel material for chemical compatibility
- Push to connect operation
- Fluorocarbon standard seal material with options available

Applications include:

- Chemical dispensing systems
- Chemical processing
- Food processing
- Corrosive media transfer

Materials of Construction

- Machined Parts:** Stainless Steel, AISI type 316
Springs: Stainless Steel, AISI type 316.
Locking Balls: 1/4 - 3/8": 302 SS;
 1/2 - 3/4": 316 SS
 1": 440 SS
Backup Washers: PTFE
Elastomer Seals: Fluorocarbon is standard.
 Wide range is available.

Specifications					
Body Size	Rated Pressure (psi)	Rated Flow (gpm)	Spillage (ml) max. per disconnect	Air Inclusion (ml) max. per connect	CV
1/4	2000	3	.015	.010	0.90
3/8	2000	6	.015	.020	1.80
1/2	2000	12	.020	.070	3.00
3/4	2000	28	.150	.100	7.00
1	2000	50	.250	.182	10.1

Temperature Range (continuous)		
Part No. Seal Suffix	Seal Compound	Temp° F Rating
None*	Fluorocarbon	-15 to 400
E5	Ethylene Propylene (EPR)	-65 to 300
E1	Nitrile	-40 to 250
E35	Perfluoroelastomer (Contact QCD)	-20 to 600

*Fluorocarbon is standard seal.
 Contact QCD for availability and additional options.
 To select proper seal materials, see Fluid Compatibility Chart or contact QCD.

Optional Seal Materials:

Code	Description	Part Number Example
suffix -E5	Ethylene Propylene seal material- EPR)	FS-371-6FP-E5
suffix -E12	Neoprene seal material	FS-371-6FP-E12

Performance Flow Data

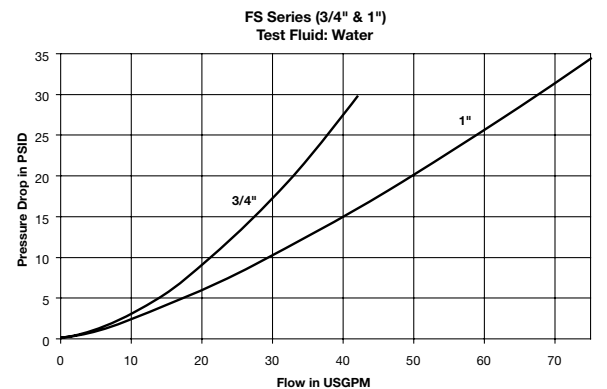
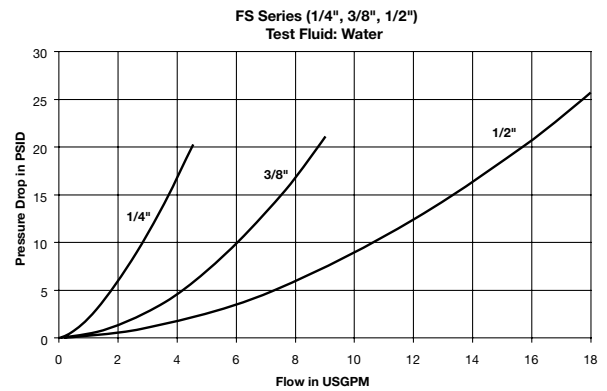



FS Series Couplers - Female Thread



Body Size	Coupler Part Number	Port End	Length	Largest Diameter	Wrench Flats	Weight (lbs.)
1/4	FS-251-4FP	1/4-18 NPT	1.79	1.06	1.00	0.25
1/4	FS-251-4MP	1/4-18 NPTF	2.00	1.06	1.00	0.25
1/4	FS-251-6FO	9/16-18UNF	1.92	1.06	1.00	0.24
3/8	FS-371-6FP	3/8-18 NPT	2.52	1.30	1.06	0.58
3/8	FS-371-8FO	3/4-16 UNF	2.83	1.30	1.06	0.63
1/2	FS-501-8FP	1/2-14 NPT	2.74	1.58	1.38	0.92
1/2	FS-501-10FO	7/8-14 UNF	2.86	1.58	1.38	0.96
3/4	FS-751-12FP	3/4-14 NPT	3.63	1.99	1.75	2.00
3/4	FS-751-12FO	1-1/16-12 UNF	3.73	1.99	1.75	2.04
1	FS-1001-16FP	1-11 1/2 NPT	4.14	2.25	1.87	2.76
1	FS-1001-16FO	1-5/16-12 UNF	4.24	2.25	1.87	2.80

FS Series Nipples - Female Thread



Body Size	Coupler Part Number	Port End	Overall Length	Exposed Length*	Largest Diameter	Wrench Flats	Weight (lbs.)
1/4	FS-252-4FP	1/4-18 NPT	1.66	1.14	1.06	1.00	0.18
1/4	FS-252-4MP	1/4-18 NPTF	1.87	1.34	1.06	1.00	0.18
1/4	FS-252-6FO	9/16-18 UNF	1.78	1.26	1.06	1.00	0.17
3/8	FS-372-6FP	3/8-18 NPT	2.31	1.71	1.08	0.94	0.26
3/8	FS-372-8FO	3/4-16 UNF	2.45	1.71	1.19	1.06	0.30
1/2	FS-502-8FP	1/2-14 NPT	2.75	2.03	1.30	1.12	0.44
1/2	FS-502-10FO	7/8-14 UNF	2.85	2.11	1.30	1.12	0.48
3/4	FS-752-12FP	3/4-14 NPT	3.38	2.37	1.65	1.50	1.02
3/4	FS-752-12FO	1-1/16-12 UNF	3.38	2.37	1.65	1.50	1.02
1	FS-1002-16FP	1-11 1/2 NPT	3.89	2.60	2.17	1.87	1.60
1	FS-1002-16FO	1-5/16 12 UNF	3.89	2.51	2.17	1.87	1.64

Standard Port Configurations: FP - Female Pipe Thread MP - Male Pipe Thread FO - Female Straight Thread

* This dimension represents the portion of the nipple that is exposed when the nipple and coupler are connected.

Dust Caps - FS Series



Body Size	Coupler Dust Cap - Rubber	Nipple Dust Cap - Rubber
1/4	FR-25	FR-25
3/8	NR-50	NR-37
1/2	FR-501	FR-502
3/4	FR-751	FR-752
1	FR-1001	FR-1002



FS Series Repair Kits

Repair kits are available for both coupler and nipple half of FS coupling. Kits include replacement elastomer seals, valve assembly and instructions to perform rebuild. Spline tool must be ordered separately to accomplish coupler half repair. Other tools required: Vise, Allen Wrench and Open End Wrench.

FS Repair Kits		
TOOL Spline tool for Coupler Repair	Replacement Seals	
	No Suffix	Fluorocarbon Seals
	E5	Ethylene Propylene (EPR)
	E35	Perfluoroelastomer (Contact Factory for Seal Options).

Nipple Repair Kits		
1/4	FS-252-KIT	FS-252-KIT-E5
3/8	FS-372-KIT	FS-372-KIT-E5
1/2	FS-502-KIT	FS-502-KIT-E5
3/4	FS-752-KIT	FS-752-KIT-E5
1	FS-1002-KIT	FS-1002-KIT-E5

Coupler Repair Kits			Spline Tool
1/4	N/A	N/A	N/A
3/8	FS-371-KIT	FS-371-E5	FF/FS-371-TOOL
1/2	FS-501-KIT	FS-501-KIT-E5	FS-501-TOOL
3/4	FS-751-KIT	FS-751-KIT-E5	FF/FS-751-TOOL
1	FS-1001-KIT	FS-1001-KIT-E5	FF/FS-751-TOOL



FET Series couplings are built to be used in high pressure, high impulse applications that require the security of a threaded connection and the ability to connect and disconnect under residual pressure. Interchanges with similar European style thread-to-connect couplings.

Features:

- Connect under residual pressure up to 5000 psi
- Disconnect under residual pressure up to 2500 psi
- High impulse resistance
- High strength materials
- FNC coating for extended durability and corrosion resistance
- Visual connection indicator

Applications include:

- Mobile drill rigs
- Oil field equipment
- Umbilical lines
- High impulse mobile circuits
- Excavator attachments

FET Series Specifications							
Body Size (inch)	Euro Size	Port End	Rated Pressure (psi)	Temperature Range	Body Material	Sleeve Type	Seal Material
3/8	9	Female ORB	6000	-40° to +250°F	Steel	Thread to Connect	Nitrile/Polyurethane
		Female NPTF	6000				
1/2	13	Female ORB	6000				
		Female NPTF	6000				
5/8	15	Female ORB	5000				
		Female NPTF	5000				
3/4	17	Female ORB	5000				
		Female NPTF	5000				
		Code 62 Flange Head	6000				
		Code 62 Flange Pad	6000				
1	21	Female ORB	3000				
		Female NPTF	5000				
		Code 62 Flange Head	6000				
		Code 62 Flange Pad	6000				
1-1/2	30	Female ORB	2500				
		Female NPTF	3000				
		Code 62 Flange Head	5000				
		Code 62 Flange Pad	5000				

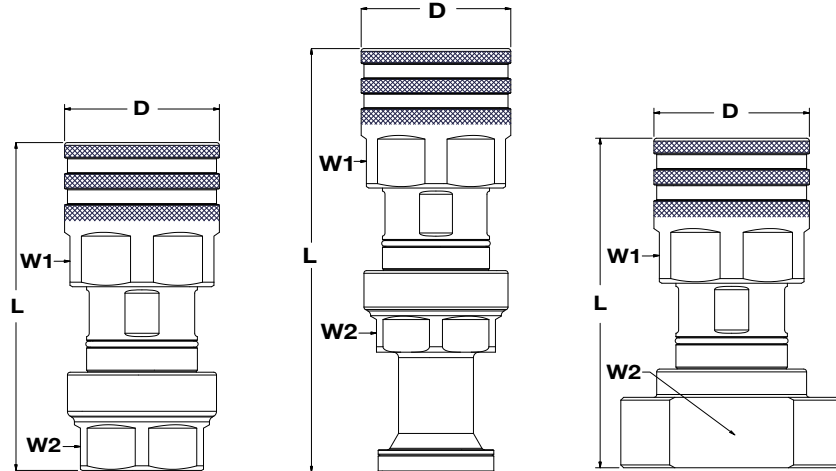

FET Series Couplers



Body Size	Coupler Part Number	Port End	Length (in)	Largest Diameter (in)	Wrench Flats W1	Wrench Flats W2	Weight (lbs.)
3/8	FET-371-8FO	3/4 -16 UNF	3.83	1.65	38 mm	30 mm	0.91
3/8	FET-371-8FP	1/2 -14 NPTF	3.91	1.65	38 mm	30 mm	0.92
1/2	FET-501-10FO	7/8 -14 UNF	3.82	2.05	48 mm	1-1/2 in	1.40
1/2	FET-501-8FP	1/2 -14 NPTF	3.70	2.05	48 mm	1-1/2 in	1.38
5/8	FET-621-12FO	1 1/16 -12 UNF	4.66	2.12	50 mm	1-5/8 in	2.06
5/8	FET-621-12FP	3/4 -14 NPTF	4.52	2.12	50 mm	1-5/8 in	2.03
3/4	FET-751-16FO	1 5/16 -12 UNF	5.44	2.31	55 mm	2 in	3.30
3/4	FET-751-16FP	1 - 11 1/2 NPTF	5.44	2.31	55 mm	2 in	3.35
1	FET-1001-20FO	1 5/8 - 12 UNF	5.83	2.75	65 mm	2-3/16 in	4.72
1	FET-1001-20FP	1 1/4 -11 1/2 NPTF	5.83	2.75	65 mm	2-3/16 in	4.76
1-1/2	FET-1501-24FO	1 7/8 - 12 UNF	7.08	3.75	85 mm	2-5/8 in	10.01
1-1/2	FET-1501-24FP	1 1/2 -11 1/2 NPTF	7.08	3.75	85 mm	2-5/8 in	10.06

FET Series Couplers - Code 62 Flange



Body Size	Coupler Part Number	Port End	Bolt Thread Size	Length (in)	Largest Diameter (in)	Wrench Flats W1 (mm)	Wrench Flats W2 (in)	Weight (lbs.)
3/4	FET-751-16SF	Flange Head	-	7.60	2.31	55	2	4.17
3/4	FET-751-16SFP	Flange Pad	7/16 - 14 UNC	5.45	2.31	55	2-3/4	4.82
1	FET-1001-20SF	Flange Head	-	7.78	2.75	65	2-3/16	5.44
1	FET-1001-20SFP	Flange Pad	1/2 - 13 UNC	5.83	2.75	65	3	6.90
1-1/2	FET-1501-24SF	Flange Head	-	9.83	3.75	85	2-5/8	11.37
1-1/2	FET-1501-24SFP	Flange Pad	5/8 - 11 UNC	6.82	3.75	85	2-5/8	13.31

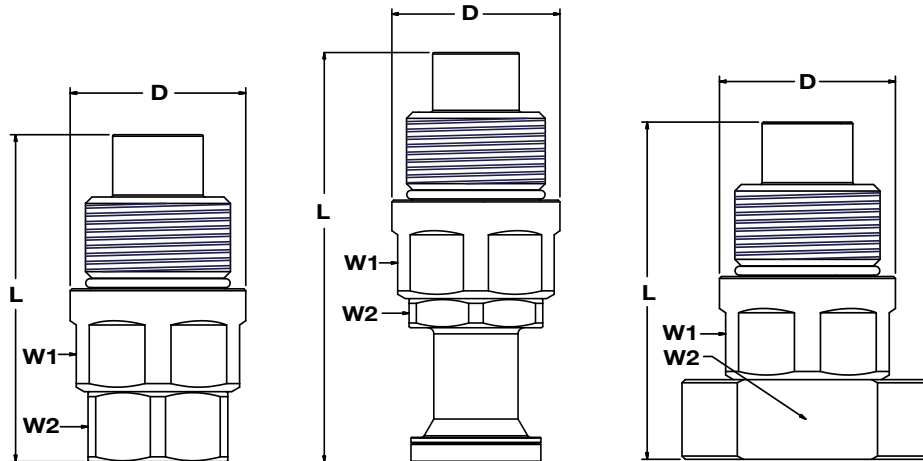

FET Series Nipples



Body Size	Nipple Part Number	Port End	Length (in)	Largest Diameter (in)	Wrench Flats W1	Wrench Flats W2	Weight (lbs.)
3/8	FET-372-8FO	3/4 -16 UNF	3.51	1.60	38 mm	1-1/4 in	0.99
3/8	FET-372-8FP	1/2 -14 NPTF	3.51	1.60	38 mm	1-1/4 in	0.99
1/2	FET-502-10FO	7/8 -14 UNF	3.70	1.88	44 mm	1-1/8 in	1.14
1/2	FET-502-8FP	1/2 -14 NPTF	3.50	1.88	44 mm	1-1/8 in	1.13
5/8	FET-622-12FO	1 1/16 -12 UNF	4.21	2.12	50 mm	1-5/8 in	2.05
5/8	FET-622-12FP	3/4 -14 NPTF	4.08	2.12	50 mm	1-5/8 in	2.02
3/4	FET-752-16FO	1 5/16 -12 UNF	4.72	2.31	55 mm	2 in	2.76
3/4	FET-752-16FP	1 - 11 1/2 NPTF	4.65	2.31	55 mm	2 in	2.72
1	FET-1002-20FO	1 5/8 - 12 UNF	5.12	2.75	65 mm	2-3/16 in	4.31
1	FET-1002-20FP	1 1/4 -11 1/2 NPTF	5.12	2.75	65 mm	2-3/16 in	4.35
1-1/2	FET-1502-24FO	1 7/8 - 12 UNF	5.94	3.75	75 mm	2-5/8 in	7.94
1-1/2	FET-1502-24FP	1 1/2 -11 1/2 NPTF	5.94	3.75	75 mm	2-5/8 in	8.00

FET Series Nipples - Code 62 Flange



Body Size	Nipple Part Number	Port End	Bolt Thread Size	Length (in)	Largest Diameter (in)	Wrench Flats W1 (mm)	Wrench Flats W2 (in)	Weight (lbs.)
3/4	FET-752-16SF	Flange Head	-	6.32	2.31	55	2	3.10
3/4	FET-752-16SFP	Flange Pad	7/16 - 14 UNC	4.74	2.31	55	2-3/4	4.33
1	FET-1002-20SF	Flange Head	-	6.70	2.75	65	2-3/16	4.71
1	FET-1002-20SFP	Flange Pad	1/2 - 13 UNC	5.27	2.75	65	3	6.78
1-1/2	FET-1502-24SF	Flange Head	-	7.77	3.75	75	2-5/8	8.08
1-1/2	FET-1502-24SFP	Flange Pad	5/8 - 11 UNC	5.94	3.75	75	2-5/8	12.17



FET Series Dust Caps and Plugs



Body Size	Nipple Dust Cap	Coupler Dust Plug
3/8	FET3DC-01	FET3DP-01
1/2	FET5DC-01	FET5DP-01
5/8	FET6DC-01	FET6DP-01
3/4	FET7DC-01	FET7DP-01
1	FET10DC-01	FET10DP-01
1-1/2	FET15DC-01	FET15DP-01

Hydraulic Quick Couplings

Connect Under Pressure

6100 Series

Threaded Connection

Flush valves, high flow



B Hydraulics



6100 Series is a thread to connect, low spill coupling that can be connected under pressure. Coupler and nipple bodies are corrosion resistant brass. Couplers are available with a steel hex nut or heavy duty wing nut sleeve. A connection indicator groove on the nipple body indicates when the connection is complete and the valves are fully open.

Features:

- Rated pressures up to 3000 psi
- Thread to connect operation
- Bonded valve seal stays in place under full pressure connect and disconnect
- Visual connection indicator
- Rugged wing nut sleeve will withstand hammering to tighten or loosen
- Optional flange for secure bulkhead mounting
- Standard end configuration is female pipe thread
- Special part numbers apply for CO2 transfer (contact QCD)

Applications:

- Submersible pumps
- Oil field equipment
- Dump trailers
- Engine test stands
- Bulk liquid transfer

Performance

6100 Series (1/2" & 3/4")
Test Fluid: OIL 150 SUS

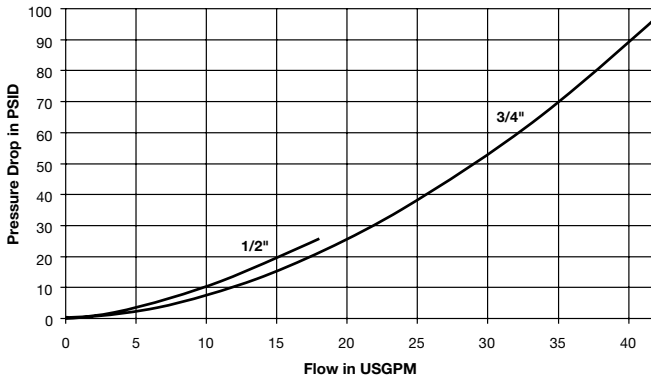

6100 Series (1", 1-1/4", 1-1/2")
Test Fluid: OIL 150 SUS

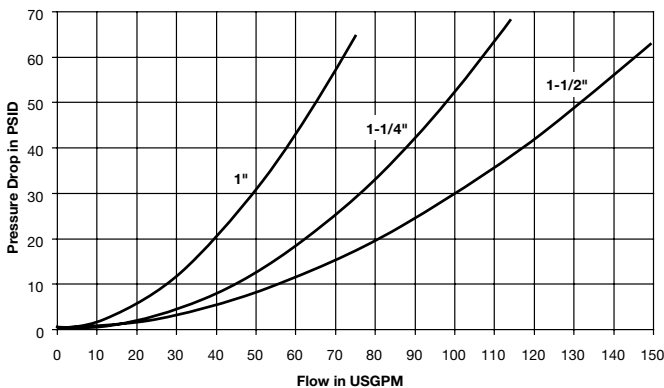

Specifications

Body Size	3/4	3/4	1	1 - 1/4	1 - 1/2
Dash Number	-08	-12	-16	-20	-24
Rated Pressure (psi) *					
Female Half	3,000	3,000	3,000	2,750	2,000
Male Half	3,000	3,000	3,000	2,500	2,500
Complete Coupling Assembly	3,000	3,000	3,000	2,750	2,500
Rated Flow (gpm)	12	28	50	76	100
Temperature Range (std seals)	-40° to +250°F				

* Not recommended for continuous hydraulic impulse applications at rated pressures.



Coupling Set with Wingnut



Body Size	Part Number With Flange	Part Number Without Flange	Thread Size	Overall Connected Length	Weight (lbs.)
3/4	6100-08	6120-08	1/2-14 NPTF	5.20	2.12
3/4	6100-12	6120-12	3/4-14 NPTF	5.32	2.00
1	6100-16	6120-16	1-11 1/2 NPTF	5.99	3.19
1 1/4	6100-20	6120-20	1 1/4-11 1/2 NPTF	6.48	4.25
1 1/2	6100-24	6120-24	1 1/2-11 1/2 NPTF	6.80	6.13

Coupling Set with Hex Nut



Body Size	Part Number With Flange	Part Number Without Flange	Thread Size	Overall Connected Length	Weight (lbs.)
3/4	6110-08	6130-08	1/2-14 NPTF	5.20	1.89
3/4	6110-12	6130-12	3/4-14 NPTF	5.20	1.83
1	6110-16	6130-16	1-11 1/2 NPTF	5.99	2.93
1 1/4	6110-20	6130-20	1 1/4-11 1/2 NPTF	6.33	4.12
1 1/2	6110-24	6130-24	1 1/2-11 1/2 NPTF	6.55	5.95

Dust Caps for Nipples



Body Size	Dust Cap - Nipples
3/4	6108-08
1	6108-16
1 1/4	6108-20
1 1/2	6108-24

Dust Plugs for Couplers



Body Size	Dust Plug - Couplers
3/4	6109-08
1	6109-16
1 1/4	6109-20
1 1/2	6109-24

Optional Seal Materials:

(add code to part number)

Code	Description	Part Number Example
suffix W	Ethylene Propylene seal material- EPR	6135-08W
suffix Y	Fluorocarbon seal material	6135-08Y
suffix Z	Neoprene seal material	6135-08Z

Contact QCD for availability and additional options.
To select proper seal materials, see Fluid Compatibility Chart or contact QCD.



Couplers - Wingnut



Body Size	Part Number Brass	Thread Size	Overall Length	Wrench Flats	Wing Nut	Weight (lbs.)
3/4	6125-08	1/2-14 NPTF	3.22	1.16	4.06	1.30
3/4	6125-12	3/4-14 NPTF	3.22	1.16	4.06	1.26
1	6125-16	1-11 1/2 NPTF	3.87	1.43	4.38	1.96
1 1/4	6125-20	1 1/4-11 1/2 NPTF	4.16	1.78	5.20	2.84
1 1/2	6125-24	1 1/2-11 1/2 NPTF	4.34	2.00	5.32	3.72

Couplers - Hex Nut



Body Size	Part Number Brass	Thread Size	Overall Length	Wrench Flats	Hex Size	Weight (lbs.)
3/4	6135-08	1/2-14 NPTF	3.22	1.16	1.75	1.07
3/4	6135-12	3/4-14 NPTF	3.22	1.16	1.75	1.07
1	6135-16	1-11 1/2 NPTF	3.87	1.43	2.13	1.89
1 1/4	6135-20	1 1/4-11 1/2 NPTF	4.16	1.78	2.50	2.56
1 1/2	6135-24	1 1/2-11 1/2 NPTF	4.34	2.00	2.75	3.15

Nipples



Body Size	Part Number Without Flange Brass	Part Number With Flange Brass	Thread Size	Overall Length	Wrench Flats	Hex Size	Weight (lbs.)
3/4	6105-08	6115-08	1/2-14 NPTF	3.11	1.18	1.62	0.75
3/4	6105-12	6115-12	3/4-14 NPTF	3.23	1.18	1.62	0.76
1	6105-16	6115-16	1-11 1/2 NPTF	3.55	1.56	1.88	1.30
1 1/4	6105-20	6115-20	1 1/4-11 1/2 NPTF	3.71	1.88	2.13	1.65
1 1/2	6105-24	6115-24	1 1/2-11 1/2 NPTF	4.12	2.18	2.50	2.61

Mounting Flanges



Body Size	Part Number Steel	Bolt Hole Diameter	Bolt Circle Diameter
3/4	6107-08 (1 piece)	.208	2.13
1	6107-16 (1 piece)	.208	2.38
1 1/4	6107-20 (2 piece)	.208	2.63
1 1/2	6107-24 (2 piece)	.281	3.25



Parker's 8200 Series unique valve design allows connection while either or both the coupler and nipple are under pressure. Valves in both halves remain closed, opening only when system pressure has been relieved on the female body and then reapplied. This pressure sequence may be done with either an open center or a closed center hydraulic system that has a control valve.

Features:

- Accepts ISO 5675 universal tips
- Connect under system pressure on the coupler side and residual pressure on the nipple side
- Sleeve designed to accommodate bracket mounting
- One-handed push-to-connect operation when coupler is clamp mounted
- 1/2" body size couplers are compatible with 5001-4 and 5006-4 breakaway clamps
- Critical parts are hardened
- Protective zinc plating with clear trivalent chromate finish

Applications include:

- Tractors
- Mid-sized agricultural equipment
- Agricultural attachments requiring breakaway

8200 Series Specifications						
Body Size	Rated Flow	Rated Pressure	Temperature	Body Material	Sleeve Type	Seal Material
1/2	12 gpm	3000 psi	-40° F to +250° F	Steel	Push/pull/break away	Nitrile

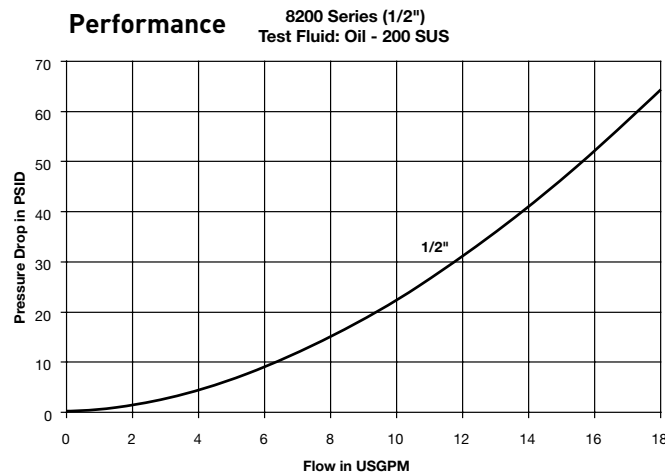

Optional Seal Materials:

(add code to part number)

Code	Description	Part Number Example
suffix W	Ethylene Propylene seal material- EPR (Couplers)	8250-15W
suffix Y	Fluorocarbon seal material (Couplers)	8250-15Y
suffix Z	Neoprene seal material (Couplers)	8250-15Z

Contact QCD for availability and additional options.
To select proper seal materials, see Fluid Compatibility Chart or contact QCD.



8200 Series Couplers - Female Thread



Body Size	Coupler Part Number	Port End	Valve Type	Length	Largest Diameter	Wrench Flats	Weight (lbs.)	Complete Coupling Part Number
1/2	8250-4	1/2-14 NPSF	Poppet	3.29	1.50	0.87	0.63	8200-4
1/2	8250-15	3/4-16 ORB	Poppet	3.29	1.50	0.87	0.63	8200-15
1/2	8250-16	7/8-14 ORB	Poppet	3.29	1.50	0.87	0.63	8200-16

8010 Series Nipples - Female Thread



Body Size	Nipple Part Number	Port End	Valve Type	Length	Largest Diameter	Wrench Flats	Weight (lbs.)	Complete Coupling Part Number
1/2	8010-4	1/2-14 NPTF	Ball	1.95	1.23	1.06	0.20	8200-4
1/2	8010-4P	1/2-14 NPTF	Poppet	1.95	1.23	1.06	0.20	-
1/2	8010-15	3/4 -16 ORB	Ball	1.95	1.23	1.06	0.20	8200-15
1/2	8010-15P	3/4 -16 ORB	Poppet	1.95	1.23	1.06	0.20	-
1/2	8010-16	7/8 -14 ORB	Ball	1.95	1.23	1.06	0.25	8200-16
1/2	8010-16P	7/8 -14 ORB	Poppet	1.95	1.23	1.06	0.25	-

8200 Series Replacement Parts

Body Size	Part Number	Description	Material
1/2	50005-211-0200	O-Ring	Nitrile

8200 Series Dust Caps and Plugs



Body Size	Dust Plug (Coupler)	Color/Material	Dust Cap (Nipple)	Weight (lbs.)
1/2	5205-4M	Black Rubber	5209-4M	.04
1/2	5005-4	Steel w/Chain	5009-4	.21
1/2	5205-4M-BU	Blue Rubber	5209-4M-BU	.04
1/2	5205-4M-GR	Green Rubber	5209-4M-GR	.04
1/2	5205-4M-RE	Red Rubber	5209-4M-RE	.04
1/2	5205-4M-YE	Yellow Rubber	5209-4M-YE	.04



The 9200 Series coupler allows zero pressure connection and disconnection while either or both the coupler and nipple are under pressure. A lever operated cam locks both coupler and nipple valves in the open or closed position. "Closed", the flow is shut off at the coupler, allowing easy connect and disconnect. Valves in the "Open" position are locked in place and unaffected by hydraulic surges. Valves will automatically close if the coupling is accidentally disconnected.



Features:

- Accepts ISO 5675 universal tips
- Premier connect under pressure coupling
- Locked valves prevent flow checking
- Functionally can replace a double shut-off quick coupling and two high pressure ball valves
- Protective zinc plating with clear trivalent chromate finish

Applications include:

- Mobile equipment
- Industrial hydraulics
- Not recommended for use with gaseous or compressible media

9200 Series Specifications:

Body Size	Rated Flow	Rated Pressure	Temperature	Body Material	Sleeve Type	Seal Material
1/2	12 gpm	3000 psi	-40° F to +250° F	Steel	Push/pull/breakaway	Nitrile

Performance:

9200 Series (1/2")
Test Fluid: Oil - 200 SUS

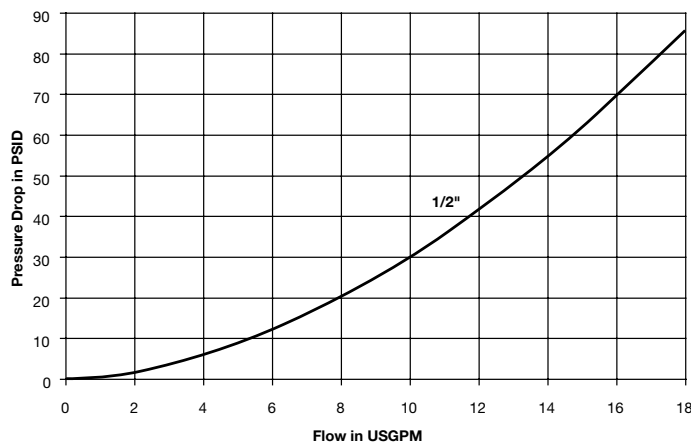

Optional Seal Materials:

[add code to part number]

Code	Description	Part Number Example
suffix W	Ethylene Propylene seal material- EPR (Couplers)	9250-4-320W
suffix Y	Fluorocarbon seal material (Couplers)	9250-4-320Y
suffix Z	Neoprene seal material (Couplers)	9250-4-320Z

Contact QCD for availability and additional options.
To select proper seal materials, see Fluid Compatibility Chart or contact QCD.



9200 Series Couplers



Body Size	Coupler Part Number	Port End	Valve Type	Orientation	Length	Largest Diameter	Wrench Flats	Weight (lbs.)
1/2	9250-4-320*	1/2-14 NPTF	Poppet	Left hand – yellow grip	5.37	1.50	1.13	1.98
1/2	9250-6-320*	9/16-18 UNF	Poppet	Left hand – yellow grip	5.37	1.50	1.13	2.06
1/2	9250-15-320*	3/4-16 UNF	Poppet	Left hand – yellow grip	5.37	1.50	1.13	2.06
1/2	9250-16-320*	7/8-14 UNF	Poppet	Left hand – yellow grip	5.37	1.50	1.13	2.06
1/2	9250-334**	9/16-18 UNF	Poppet	Left hand – yellow grip	5.37	1.50	1.13	2.15

* -320 indicates lower sleeve spring force for easier connection when coupler is not mounted in a clamp.

** -334 couplers connect with 1/4" ISO 7241-B series nipples.

8010 Series Nipples



Body Size	Nipple Part Number	Port End	Valve Type	Length	Largest Diameter	Wrench Flats	Weight (lbs.)
1/4	H2-63-T6*	9/16-18 ORB	Poppet	1.54	1.01	0.88	0.10
1/2	8010-4	1/2-14 NPTF	Ball	1.95	1.23	1.06	0.20
1/2	8010-4P	1/2-14 NPTF	Poppet	1.95	1.23	1.06	0.20
1/2	8010-15	3/4-16 ORB	Ball	1.95	1.23	1.06	0.20
1/2	8010-15P	3/4-16 ORB	Poppet	1.95	1.23	1.06	0.20
1/2	8010-16	7/8-14 ORB	Ball	1.95	1.23	1.06	0.25
1/2	8010-16P	7/8-14 ORB	Poppet	1.95	1.23	1.06	0.25

* Connects with 9250-334 couplers

9200 Series Replacement Parts

Body Size	Part Number	Description	Weight (lbs.)
1/2	50001-211-0260	Interface O-Ring	.01

9200 Series Dust Caps and Plugs



Body Size	Coupler Dust Cover	Color/Material	Nipple Dust Cap	Weight (lbs.)
1/2	9507-4-1	Black Rubber	5209-4M	.04



The 5000 Series is an economical coupling that can be connected under pressure where tools can be used to make the connection. The coupler and nipple are connected and then the valves are opened from tightening the threaded union on the back of the coupler body. Unscrewing the body threads will permit the valves to close and the coupler sleeve can be retracted to release the nipple.

Features:

- Accepts ISO 5675 universal tips
- Manual, threaded actuation, connect under pressure coupling
- Protective zinc plating with clear trivalent chromate finish

Applications include:

- Lubrication systems
- Hydraulic tools
- Attachments

5000 Series Specifications						
Body Size	Rated Flow	Rated Pressure	Temperature	Body Material	Sleeve Type	Seal Material
1/2	12 gpm	2500 psi	-40° F to +250° F	Steel	Single Acting	Nitrile

Performance:

5000 Series (1/2")
Test Fluid: Oil - 200 SUS

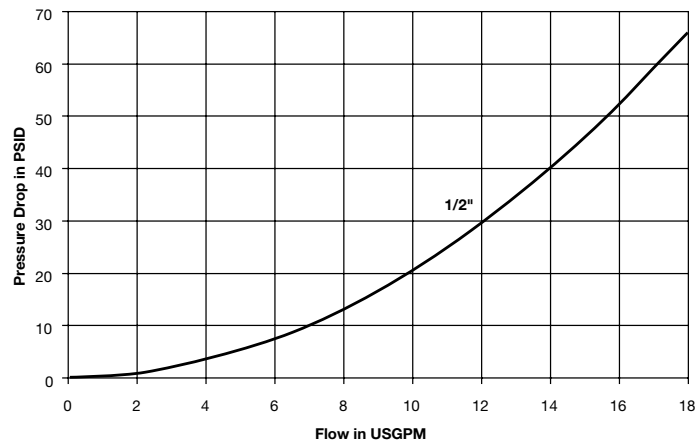



5000 Series Couplers



Body Size	Coupler Part Number	Port End	Valve Type	Length	Largest Diameter	Wrench Flats	Weight (lbs.)	Complete Coupling Part Number
1/2	5050-4	1/2-14 NPTF	Ball	2.88	1.52	1.25	2.58	5000-4

8010 Series Nipples



Body Size	Nipple Part Number	Port End	Valve Type	Length	Largest Diameter	Wrench Flats	Weight (lbs.)	Complete Coupling Part Number
1/2	8010-4	1/2-14 NPTF	Ball	1.95	1.23	1.06	0.20	5000-4
1/2	8010-15	3/4-16 ORB	Ball	1.95	1.23	1.06	0.20	-
1/2	8010-16	7/8-14 ORB	Ball	1.95	1.23	1.06	0.25	-

5000 Replacement Parts

1/2

O-Rings - Nitrile	50001-211-0260
--------------------------	----------------

5000 Series Dust Caps and Plugs



Body Size	Dust Plug (Coupler)	Color/Material	Dust Cap (Nipple)	Weight (lbs.)
1/2	5205-4M	Black Rubber	5209-4M	.04
1/2	5205-4M-BU	Blue Rubber	5209-4M-BU	.04
1/2	5205-4M-GR	Green Rubber	5209-4M-GR	.04
1/2	5205-4M-RE	Red Rubber	5209-4M-RE	.04
1/2	5205-4M-YE	Yellow Rubber	5205-4M-YE	.04
1/2	5005-4	Steel w/Chain	5009-4	.21

Optional Seal Materials:

(add code to part number)

Code	Description	Part Number Example
suffix W	Ethylene Propylene seal material- EPR (Couplers)	5050-4W
suffix Y	Fluorocarbon seal material (Couplers)	5050-4Y
suffix Z	Neoprene seal material (Couplers)	5050-4Z

Contact QCD for availability and additional options.
To select proper seal materials, see Fluid Compatibility Chart or contact QCD.

Hydraulic Quick Couplings

Connect Under Pressure

Snap-tite 75 Series Threaded Connection

Poppet valves, high pressure



The rugged 75 Series is designed and constructed for high pressure hydraulic service. Although these couplings are used in a broad variety of heavy duty applications, a primary usage is in oil fields and offshore drilling. Available in sizes 3/4" through 4", in steel or stainless steel construction.

Features:

- Connect under residual pressure
- Thread-to-connect
- Up to 5,000 psi (345 bar) rated pressures
- Rugged steel construction with Zinc Trivalent Chromate plating
- Stainless steel construction also available
- Wide range of sizes
- Nitrile is standard seal material, other options available
- DBP version is "Fire Safe" rated to API 16D

Applications include:

- Cranes
- Power tongs
- Horizontal boring and dewatering

B Hydraulics

75 Series Pressure Ratings			
Body Size	Maximum Working Pressure (psi) Steel Only	Minimum Burst Pressure (psi) Steel Only	Maximum Working Pressure (psi) 316 Stainless (Connected Only)
3/4	5000	20000	3000
1	5000	20000	3000
1-1/4	5000	15000	3000
1-1/2	5000	15000	3000
2	5000	15000	3000
2-1/2	3000	6000	-
3	3000	6000	-
4	400	1000	-

Burst pressures listed were taken at the point at which failure rendered the quick-disconnect inoperative. (Proof pressure equals 1-1/2 times the operating pressure).

NOTE: Pressure Ratings were established under static pressure conditions.

For impulse applications, multiply the above pressure ratings by .6 for approximate pressure ratings.

-Contact QCD

75 Series Specifications								
Body Size	3/4	1	1-1/4	1-1/2	2	2-1/2	3	4
Spillage (cc)	8	16	31	64	141	204	320	400
Air Inclusion (cc)	12	25	48	98	205	368	480	610



Performance

Torque Values for Connecting Under Pressure

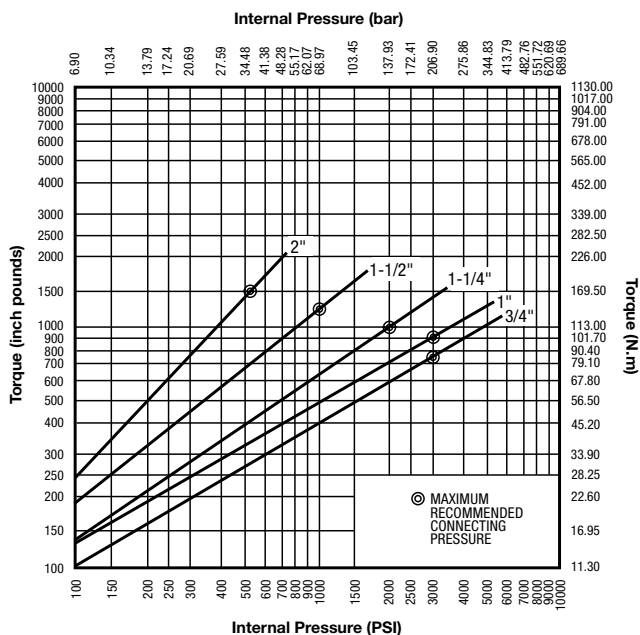

Flow Chart

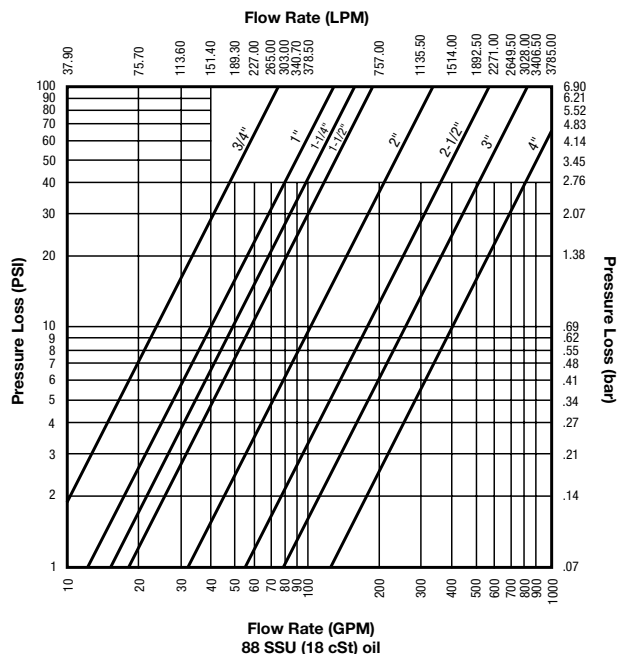

75 Series Dust Plugs and Caps

Body Size	3/4	1	1-1/4	1-1/2	2	2-1/2	4
Dust Plugs (Coupler)	75MDP-12	75MDP-16	75MDP-20	75MDP-24	75MDP-32	75MDP-40	75MDP-64
Dust Caps (Nipple)	75MDC-12	75MDC-16	75MDC-20	75MDC-24	75MDC-32	75MDC-40	75MDC-64

75 Series Repair Kits

Body Size	3/4	1	1-1/4	1-1/2	2	2-1/2	4
Coupler Kit	75C12-SPK	75C16-SPK	75C20-SPK	75C24-SPK	75C32-SPK	75C40-SPK	75C64-SPK
Nipple Kit	75N12-SPK	75N16-SPK	75N20-SPK	75N24-SPK	75N32-SPK	75N40-SPK	75N64-SPK

Each kit contains a valve assembly, spring and guide stop. Consult QCD for "DBP" option seals.



75 Series Couplers



Body Size	Part Number Steel	Port End	Part Number 316 Stainless Steel	Port End	Length (in)	Largest Diameter	Wrench Flats
3/4	75C12-12F	3/4-14 NPSF	S75C12-12F	3/4-14 NPSF	2.84	2.06	1.31
3/4	75C12-12F-DBP	3/4-14 NPSF	-	-	2.84	2.06	N/A
1	75C16-16F	1-11-1/2 NPSF	S75C16-16F	1-11-1/2 NPSF	3.45	4.25	1.69
1	75C16-16F-DBP	1-11-1/2 NPSF	-	-	3.45	4.25	N/A
1-1/4	75C20-20F	1-1/4-11-1/2 NPTF	S75C20-20F	1-1/4-11-1/2 NPT	4.40	4.75	2.00
1-1/4	75C20-20F-DBP	1-1/4-11-1/2 NPTF	-	-	4.40	4.75	N/A
1-1/2	75C24-24F	1-1/2-11-1/2 NPTF	S75C24-24F	1-1/2-11-1/2 NPT	5.04	5.75	2.25
1-1/2	75C24-24F-DBP	1-1/2-11-1/2 NPTF	-	-	5.04	5.75	N/A
2	75C32-32F	2-11-1/2 NPT	S75C32-32F	2-11-1/2 NPT	6.07	6.75	3.00
2	75C32-32F-DBP	2-11-1/2 NPT	-	-	6.07	6.75	3.00
2-1/2	75C40-40F	2-1/2-8 NPTF	S75C40-40F	2-1/2-8 NPTF	5.29	8.00	3.50
3	75C48-48F	3-8 NPTF	S75C48-48F	3-8 NPTF	5.84	8.50	4.25

75 Series Nipples



Body Size	Part Number Steel	Port End	Part Number 316 Stainless Steel	Port End	Length (in)	Largest Diameter	Wrench Flats
3/4	75N12-12F	3/4-14 NPSF	S75N12-12F	3/4-14 NPSF	3.27	1.75	1.56
3/4	75N12-12F-DBP	3/4-14 NPSF	-	-	3.27	1.75	N/A
1	75N16-16F	1-11-1/2 NPSF	S75N16-16F	1-11-1/2 NPSF	4.17	2.25	2.00
1	75N16-16F-DBP	1-11-1/2 NPSF	-	-	4.17	2.25	N/A
1-1/4	75N20-20F	1-1/4-11-1/2 NPTF	S75N20-20F	1-1/4-11-1/2 NPT	5.36	2.62	2.38
1-1/4	75N20-20F-DBP	1-1/4-11-1/2 NPTF	-	-	5.36	2.62	N/A
1-1/2	75N24-24F	1-1/2-11-1/2 NPTF	S75N24-24F	1-1/2-11-1/2 NPT	5.97	3.25	2.88
1-1/2	75N24-24F-DBP	1-1/2-11-1/2 NPTF	-	-	5.97	3.25	N/A
2	75N32-32F	2-11-1/2 NPT	S75N32-32F	2-11-1/2 NPT	7.05	4.00	3.50
2	75N32-32F-DBP	2-11-1/2 NPT	-	-	7.05	4.00	N/A
2-1/2	75N40-40F	2-1/2-8 NPTF	S75N40-40F	2-1/2-8 NPTF	7.46	5.00	3.50
3	75N48-48F	3-8 NPTF	S75N48-48F	3-8 NPTF	8.26	6.00	4.25

Contact QCD for additional sizes and end configurations.

Optional Seal Materials and Features for Couplers and Nipples (add code to part number)

Code	Description	Part Number Example
suffix V	Fluorocarbon seal material	75C12-12F V
suffix E	Ethylene Propylene seal material (EPR)	75C12-12F E
suffix W	Wrench flats on body (standard on 2-1/2" and larger, no code required)	75C12-12F W
suffix DBP	"Fire Safe" BOP version (3/4"- 2" steel only, no alternate seal options)	SB-75C12-12F- DBP

Contact QCD for availability and additional options.

To select proper seal materials, see Fluid Compatibility Chart or contact QCD.



Parker's Snap-tite 71 Series couplings are designed for working pressures up to 10,000 psi. Available in a variety of materials and with a wide range of body sizes. Air inclusion and fluid loss are minimal with the flush face valves. Large flow chambers in the body and an exclusive valve design permit superior flow while maintaining low pressure drop.

Features:

- Flush face/Non-spill
- Push-to-connect
- Heavy duty construction
- Designed for up to 10,000 psi (690 bar) working pressures
- Variety of materials
- Wide range of sizes
- Superior flow and low pressure drop
- Sleeve lock option to protect against accidental disconnection.

Applications include:

- Industrial hydraulic lines
- Off-shore drilling



71 Series Pressure Ratings

Body Size	Steel		316 Stainless Steel		High Pressure Stainless Steel	
	Maximum Working (psi)	Minimum Burst* (psi)	Maximum Working (psi)	Minimum Burst* (psi)	Maximum Working (psi)	Minimum Burst* (psi)
1/4	10,000	20,000	5,000	12,500	10,000	20,000
3/8 x 1/4 ¹	10,000	20,000	5,000	12,500	10,000	20,000
3/8	10,000	20,000	5,000	12,500	10,000	20,000
3/8 x 1/2 ²	10,000	20,000	5,000	12,500	10,000	20,000
1/2	10,000	20,000	5,000	12,500	10,000	20,000
3/4	7,500	15,000	5,000	12,500	7,500	15,000
1	7,500	15,000	4,000	10,000	7,500	15,000
1 x 1-1/4 ³	7,500	15,000	4,000	10,000	7,500	15,000
2 x 1-1/2 ⁴	5,000	10,000	3,000	6,000	5,000	10,000
2	5,000	10,000	3,000	6,000	5,000	10,000

¹Unit is 3/8" with 1/4" end fitting. ²Unit is 3/8" with 1/2" end fitting, ³1" unit with 1-1/4" end fitting, and ⁴2" unit with 1-1/2" end fitting.

*NOTE: Pressure Ratings were established under static pressure conditions. For high impulse applications, consult QCD.

Specifications

Body Size	1/4	3/8 x 1/4 ¹	3/8	3/8 x 1/2 ²	1/2	3/4	1	1 x 1-1/4 ³	2 x 1-1/4 ⁴	2
Spillage (cc)	.02	.02	.02	.02	.03	.06	.10	.10	5.25	5.25
Air Inclusion (cc)	.01	.02	.02	.02	.03	.04	.06	.06	30.50	30.50

Maximum Recommended Connect/Disconnect Pressures

Body Size	1/4	3/8, 1/2, 3/4	1, 1-1/4	1-1/2, 2
Pressure	300	150	75	0



Performance

Sizes 1/4 thru 1-1/4

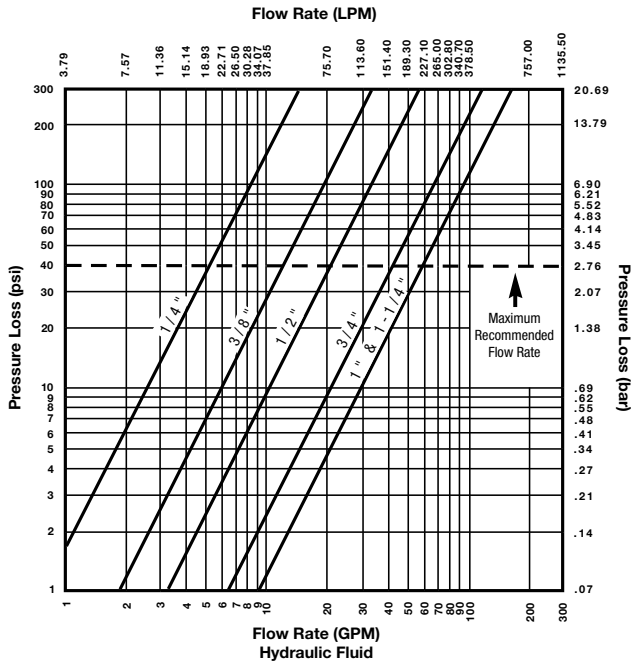

Sizes 1-1/2 and 2

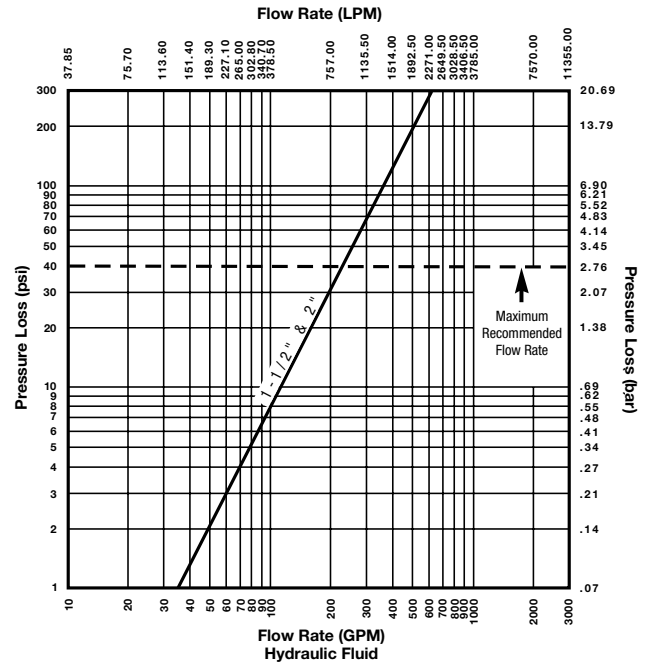

Gallons per minute (gpm) in US gallons. Test Media MIL-H-6083 Hydraulic Fluid at 90°F ± 5°F [+32°C ± 1.5°C] sg .83

Ordering Guide

71-3 C 4 - 4 F

- Options:** SL = Sleeve Lock
- Seals:**
 - Standard Seal = Nitrile
 - V = Fluorocarbon
 - E = Ethylene Propylene
 - M = MHO
- End Fitting Type:**
 - F* = Female NPTF
 - EF = Female SAE
 - RP = Female British Parallel BS2779
 - Autoclave cone & threaded fittings available (consult QCD)
- End Fitting Size:**
 - 4 = 1/4" 16 = 1"
 - 6 = 3/8" 20 = 1-1/4"
 - 8 = 1/2" 24 = 1-1/2"
 - 12 = 3/4" 32 = 2"
- Coupling Body Size:**
 - 4 = 1/4" 12 = 3/4"
 - 6 = 3/8" 16 = 1"
 - 8 = 1/2" 32 = 2"
- Coupling Half:**
 - C = Coupler
 - N = Nipple
- Series:**
 - 71 = 1-1/2" & 2" Nipples Only
 - 71-1 = 1-1/2" & 2" Couplers Only
 - 71-3 = 1/4" thru 1-1/4" Both
- Material:**
 - Blank = Steel, zinc trivalent plating
 - S = 316 Stainless Steel
 - SH = High Pressure Stainless Steel

* For sizes up to 1" NPTF threads in steel.
 For sizes up to 1" NPSF threads in stainless steel.
 For sizes over 1" NPT threads.



71 Series Couplers



Body Size	Part Number Steel	Port End	Part Number 316 Stainless Steel	Part Number High Pressure Stainless Steel	Port End	Length (in)	Largest Dia.	Wrench Flats
1/4	71-3C4-4F	1/4 - 18 NPTF	S71-3C4-4F	SH71-3C4-4F	1/4 - 18 NPTF	1.96	1.19	0.94
1/4	71-3C4-4EF	7/16 - 20 UNF	S71-3C4-4EF	-	7/16 - 20 UNF	1.96	1.19	0.94
3/8	71-3C6-4F	1/4 - 18 NPTF	-	-	-	2.36	1.56	1.19
3/8	71-3C6-6F	3/8 - 18 NPTF	S71-3C6-6F	SH71-3C6-6F	3/8 - 18 NPSF	2.36	1.56	1.19
3/8	71-3C6-6EF	9/16 - 18 UNF	S71-3C6-6EF	SH71-3C6-6EF	9/16 - 18 UNF	2.36	1.56	1.19
3/8	71-3C6-8F	1/2 - 14 NPTF	S71-3C6-8F	-	1/2 - 14 NPSF	2.57	1.56	1.19
1/2	71-3C8-8F	1/2 - 14 NPTF	S71-3C8-8F	SH71-3C8-8F	1/2 - 14 NPSF	2.77	1.88	1.50
1/2	71-3C8-8EF	7/8 - 14 UNF	S71-3C8-8EF	-	7/8 - 14 UNF	2.77	1.88	1.50
3/4	71-3C12-12F	3/4 - 14 NPTF	S71-3C12-12F	SH71-3C12-12F	3/4 - 14 NPSF	3.05	2.25	1.75
3/4	71-3C12-12EF	1-1/16 - 12 UNF	S71-3C12-12EF	-	1-1/16 - 12 UNF	3.05	2.25	1.75
1	71-3C16-16F	1 - 11-1/2 NPTF	S71-3C16-16F	SH71-3C16-16F	1 - 11-1/2 NPSF	3.32	2.63	2.00
1	71-3C16-16EF	1-5/16 - 12 UNF	S71-3C16-16EF	-	1-5/16 - 12 UNF	3.32	2.63	2.00
1	71-3C16-20F	1-1/4 - 11-1/2 NPT	S71-3C16-20F	-	1-1/4 - 11-1/2 NPT	3.32	2.63	2.00
1	71-3C16-20EF	1-5/8 - 12 UNF	S71-3C16-20EF	-	1-5/8 - 12 UNF	3.32	2.63	2.00
2	71-1C32-24F	1-1/2 - 11-1/2 NPT	-	-	-	6.21	4.50	3.38
2	71-1C32-24EF	1-7/8 - 12 UNF	-	-	-	6.21	4.50	3.38
2	71-1C32-32F	2 - 11-1/2 NPT	-	-	-	6.21	4.50	3.38
2	71-1C32-32EF	2-1/2 - 12 UNF	-	-	-	6.21	4.50	3.38



71 Series Nipples



Body Size	Part Number Steel	Port End	Part Number 316 Stainless Steel	Part Number High Pressure Stainless Steel	Port End	Length (in)	Largest Dia.	Wrench Flats
1/4	71-3N4-4F	1/4 - 18 NPTF	S71-3N4-4F	SH71-3N4-4F	1/4 - 18 NPTF	1.84	0.89	0.81
1/4	71-3N4-4EF	7/16 - 20 UNF	S71-3N4-4EF	-	7/16 - 20 UNF	1.84	0.89	0.81
3/8	71-3N6-4F	1/4 - 18 NPTF	-	-	-	1.84	1.18	1.00
3/8	71-3N6-6F	3/8 - 18 NPTF	S71-3N6-6F	SH71-3N6-6F	3/8 - 18 NPSF	2.32	1.18	1.00
3/8	71-3N6-6EF	9/16 - 18 UNF	S71-3N6-6EF	SH71-3N6-6EF	9/16 - 18 UNF	2.32	1.18	1.00
3/8	71-3N6-8F	1/2 - 14 NPTF	-	-	-	2.57	1.65	1.25
1/2	71-3N8-8F	1/2 - 14 NPTF	S71-3N8-8F	SH71-3N8-8F	1/2 - 14 NPSF	2.38	1.65	1.50
1/2	71-3N8-8EF	7/8 - 14 UNF	S71-3N8-8EF	SH71-3N8-8EF	7/8 - 14 UNF	2.38	1.65	1.50
3/4	71-3N12-12F	3/4 - 14 NPTF	S71-3N12-12F	SH71-3N12-12F	3/4 - 14 NPSF	2.96	1.92	1.75
3/4	71-3N12-12EF	1-1/16 - 12 UNF	S71-3N12-12EF	-	1-1/16 - 12 UNF	2.96	1.92	1.75
1	71-3N16-16F	1 - 11-1/2 NPTF	S71-3N16-16F	SH71-3N16-16F	1 - 11-1/2 NPSF	3.23	2.09	1.88
1	71-3N16-16EF	1-5/16 - 12 UNF	S71-3N16-16EF	-	1-5/16 - 12 UNF	3.23	2.09	1.88
1	71-3N16-20F	1-1/4 - 11-1/2 NPT	S71-3N16-20F	-	1-1/4 - 11-1/2 NPT	3.23	2.20	1.88
1	71-3N16-20EF	1-5/8 - 12 UNF	S71-3N16-20EF	-	1-5/8 - 12 UNF	3.23	2.20	1.88
2	71N32-24F	1-1/2 - 11-1/2 NPT	-	-	-	4.50	3.50	3.25
2	71N32-24EF	1-7/8 - 12 UNF	-	-	-	4.50	3.50	3.25
2	71N32-32F	2 - 11-1/2 NPT	-	-	-	4.50	3.50	3.25



The 3000 Series coupling are designed for high pressure applications. The coupler sleeve and nipple body must be manually threaded together to make the connection.

Features:

- Manual threaded connection and actuation
- Hard, chrome alloy ball valves
- Polyurethane interface seal resists high pressure extrusion
- Threaded retainer provides a positive valve stop
- Protective zinc plating with clear trivalent chromate finish

Applications include:

- Hydraulic rams
- Portable hydraulic tools
- Crimping equipment



3000 Series Specifications

Body Size	Rated Flow (gpm)	Rated Pressure (psi)	Temperature	Body Material	Sleeve Type	Seal Material
1/4	3	10,000	-22° F to +230° F	Steel	Thread to connect	Polyurethane
3/8	6			Steel	Thread to connect	Polyurethane

Performance:

3000 Series (1/4", 3/8")
Test Fluid: Oil - 200 SUS

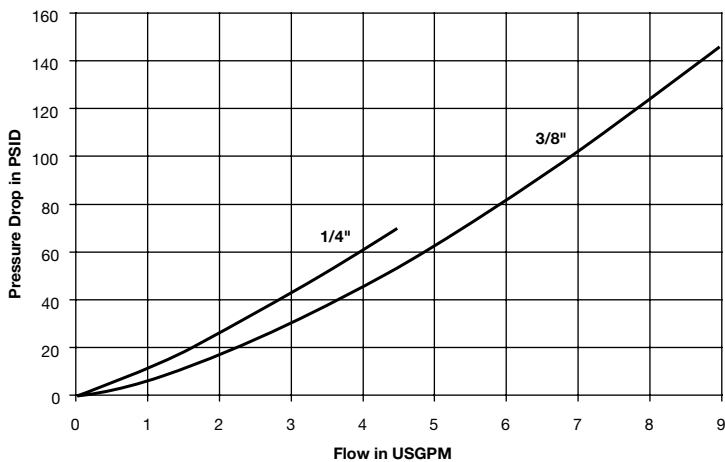



3000 Series Couplers



Body Size	Coupler Part Number	Port End	Valve Type	Length	Largest Diameter	Wrench Flats	Weight (lbs.)
1/4	3050-2	1/4-18 NPTF (Male)	Ball	2.38	1.13	0.81	0.25
3/8	3050-3	3/8-18 NPTF (Male)	Ball	2.38	1.38	1.00	0.49
3/8	3050-3-231	3/8-18 NPTF (Female)	Ball	2.38	1.38	1.00	0.49

3000 Series Nipples



Body Size	Nipple Part Number	Port End	Valve Type	Length	Largest Diameter	Wrench Flats	Weight (lbs.)
1/4	3010-2	1/4-18 NPTF (Female)	Ball	1.29	1.13	0.88	0.14
3/8	3010-3	3/8-18 NPTF (Female)	Ball	1.58	1.25	0.94	0.23
3/8	3010-3-230	3/8-18 NPTF (Male)	Ball	2.31	1.25	1.00	0.30

3000 Series Replacement O-Rings

Body Size	Material	Part Number	Durometer
1/4	Polyurethane	50001-114-0296	90
3/8	Polyurethane	50001-210-0296	90

3000 Series Dust Caps and Plugs



Body Size	Dust Cap (Nipple)	Color/Material	Dust Plug (Coupler)	Weight (lbs.)
1/4	3009-2	Steel	3005-2	.02
3/8	3009-3	Steel	3005-3	.04

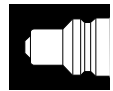

TC Series couplings are used in high pressure applications with hydraulic and mechanical shock. Steel coupler sleeves and nipple bodies are hardened for resistance to damage. Fluorocarbon seals along with PTFE back up rings provide reliable sealing in high pressures. Available in 3/8 inch size only, with sleeve lock to guard against accidental disconnection.

Features:

- Rated pressure up to 10,000 psi
- Manual sleeve operation
- Fluorocarbon seals
- Standard sleeve lock guards against accidental disconnection
- Positive valve stop prevents flow checking
- Standard end configuration is female pipe thread
- Protective zinc plating with clear trivalent chromate finish

Applications:

- Hydraulic jacking and house moving equipment
- Construction equipment
- Railway maintenance

Performance

TC Series (3/8")
Test Fluid: Oil - 200 SUS

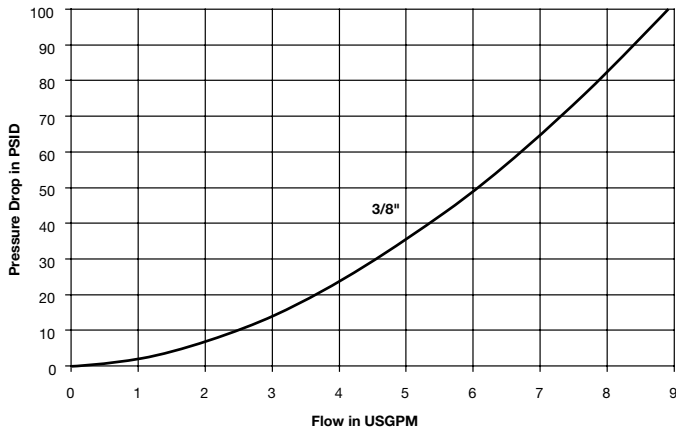

Specifications

Body Size	3/8
Rated Pressure (psi)	10,000
Rated Flow (gpm)	6
Temperature Range (std seals)	-15° to +400° F

TC Series Dust Plug/Caps

TR-37

Coupler



Body Size	Part Number	Thread Size	Overall Length	Largest Diameter	Wrench Flats	Weight (lbs.)
3/8	TC-371	3/8-18 NPSF	2.48	1.25	0.94	0.43

Nipple



Body Size	Part Number	Thread Size	Overall Length	Exposed Length	Largest Diameter	Wrench Flats	Weight (lbs.)
3/8	TC-372	3/8-18 NPSF	1.82	0.66	1.08	0.94	0.14



1141 Series are general purpose couplings that connect under pressure for high pressure applications. The 1/4 inch stainless steel coupling connects together with a threaded brass sleeve. Polyurethane seals resist extrusion and abrasion.

Features:

- 303 stainless steel body
- Rated pressure up to 10,000 psi and 17,000 psi intermittent pressure
- Small diameter mating seal keeps separation forces to a minimum, allowing easier threaded connection and disconnection at pressures up to 5,000 psi
- Polyurethane seals to resist extrusion and abrasion
- Self locking threads guard against accidental disconnection
- Visual connection indicator – when fully coupled, sleeve edge is flush with the end of the male thread
- Standard end configuration is female pipe thread
- Dust caps and plugs included

Applications:

- Off shore equipment
- Hydraulic lines in corrosive environments

Specifications	
Body Size	1/4
Rated Pressure (psi)	10,000
Rated Connect-Under-Pressure Capability (psi)	5,000
Rated Flow (gpm)	3
Temperature Range (Polyurethane seals)	-30° to +180° F
Vacuum Test	20 in/Hg
Torque to connect at 1000 psi	47 in/lbs.

Coupler						
Body Size	Part Number	Thread Size	Length	Sleeve Hex	Wrench Flat	Weight (lbs.)
1/4	1141-62	1/4-18 NPTF	2.75	1.00	0.88	0.40

Nipple						
Body Size	Part Number	Thread Size	Length	Wrench Flat	Weight (lbs.)	
1/4	1141-63	1/4-18 NPTF	2.00	0.88	0.26	



ST Series non-valved couplings provide maximum flow and low pressure drop. The smooth, open bore allows easy cleaning in applications where the same lines are used for more than one media.

Features

- Steel nipples are case hardened for resistance to Brinelling
- Functionally interchanges with similar straight-through design couplings
- Standard Nitrile seals
- Material options available
- Sleeve-Lok option available

Applications:

- High pressure water
- Steam washers
- Carpet cleaners



Specifications

Body Size	Rated Pressure (psi) Brass Coupler/Nipple	Rated Pressure (psi) Brass Coupler/Steel Nipple	Rated Pressure (psi) 303 SS Coupler/Nipple	Temperature Range (standard seals)	Rated Flow
1/8	2500	2600	4200	-40° to +250° F	3
1/4	5200	5500	6700		6
3/8	2700	3500	5500		12
1/2	2200	2700	3000		12
3/4	1700	2700	3000		28
1	1200	2000	1700		50
1-1/4	1700	-	-		76
1-1/2	1400	-	-		100

Performance

ST Series (1/8", 1/4", 3/8", 1/2")
Test Fluid: Oil - 150 SUS

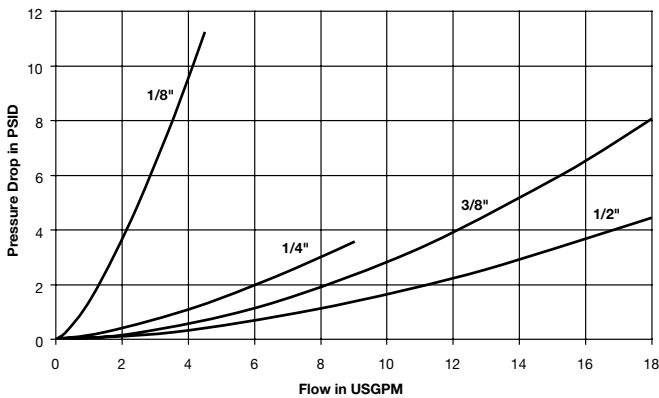

ST Series (3/4", 1", 1-1/4")
Test Fluid: Oil - 150 SUS

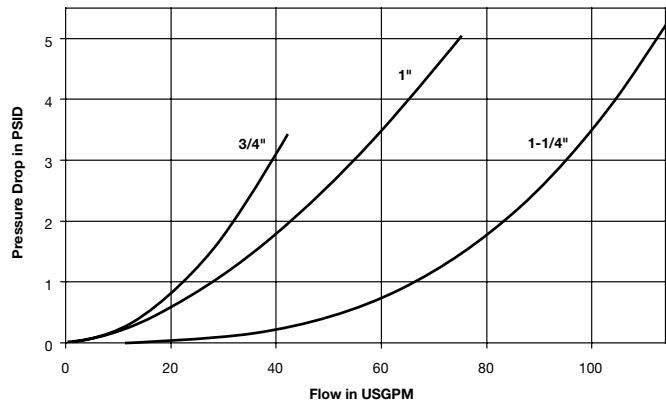



ST Series Couplers - Female Pipe Thread								
Body Size	Brass Part Number	303 Stainless Part Number	Port End	Length	Largest Diameter	Wrench Flats	Brass Weight (lbs.)	Stainless Weight (lbs.)
1/8	BST-1	SST-1	1/8-27 NPTF	1.06	0.69	0.56	0.06	0.05
1/4	BST-2	SST-2	1/4-18 NPTF	1.54	0.94	0.81	0.17	0.15
3/8	BST-3	SST-3	3/8-18 NPTF	1.64	1.16	1.00	0.26	0.24
1/2	BST-4	SST-4	1/2-14 NPTF	1.98	1.30	1.13	0.40	0.37
3/4	BST-6	SST-6	3/4-14 NPTF	2.15	1.66	1.44	0.62	0.57
1	BST-8	SST-8	1-11 1/2 NPTF	2.43	2.02	1.75	0.99	0.93
1-1/4	BST-10	-	1 1/4-11 1/2 NPTF	2.44	2.51	2.00	1.38	-
1-1/2	BST-12	-	1 1/2-11 1/2 NPTF	2.88	3.00	2.50	2.43	-

ST Series Couplers - Male Pipe Thread								
Body Size	Brass Part Number	303 Stainless Part Number	Port End	Length	Largest Diameter	Wrench Flats	Brass Weight (lbs.)	Stainless Weight (lbs.)
1/8	BST-1M	SST-1M	1/8-27 NPTF	1.06	0.69	0.56	0.05	0.05
1/4	BST-2M	SST-2M	1/4-18 NPTF	1.69	0.94	0.81	0.13	0.16
3/8	BST-3M	SST-3M	3/8-18 NPTF	1.75	1.16	1.00	0.25	1.16
1/2	BST-4M	SST-4M	1/2-14 NPTF	1.94	1.30	1.13	0.34	1.30
3/4	BST-6M	SST-6M	3/4-14 NPTF	2.17	1.66	1.44	-	1.66
1	BST-8M	SST-8M	1-11 1/2 NPTF	2.53	2.02	1.75	0.85	2.02

Optional Materials and Features:

(add code to part number)

Code	Description	Part Number Example
suffix -SL	Sleeve-Lok (Couplers)	SST-3M-SL
suffix W	Ethylene Propylene seal material- EPR (Couplers)	SST-3MW
suffix Y	Fluorocarbon seal material (Couplers)	SST-3MY
suffix Z	Neoprene seal material (Couplers)	SST-3MZ

Contact QCD for availability and additional options.

To select proper seal materials, see Fluid Compatibility Chart or contact QCD.



ST Series Nipples- Female Pipe Thread



Body Size	Brass Part No.	Weight. (lbs.)	Steel Part No.	Weight. (lbs.)	303 Stainless Part No.	Weight. (lbs.)	Length	Largest Diameter	Wrench Flats
1/8	BST-N1	0.03	ST-N1	0.03	SST-N1	0.02	0.98	0.65	0.56
1/4	BST-N2	0.07	ST-N2	0.07	SST-N2	0.07	1.46	0.87	0.75
3/8	BST-N3	0.12	ST-N3	0.11	SST-N3	0.11	1.62	1.59	0.08
1/2	BST-N4	0.23	ST-N4	0.21	SST-N4	0.21	1.85	1.30	1.13
3/4	BST-N6	0.33	ST-N6	0.32	SST-N6	0.32	2.15	1.59	1.38
1	BST-N8	0.52	ST-N8	0.49	SST-N8	0.48	2.35	1.88	1.63
1-1/4	BST-N10	0.85	-	-	-	-	2.38	2.31	2.00
1-1/2	BST-N12	1.45	-	-	-	-	2.81	2.74	2.38

ST Series Nipples- Male Pipe Thread



Body Size	Brass Part No.	Weight. (lbs.)	Steel Part No.	Weight. (lbs.)	303 Stainless Part No.	Weight. (lbs.)	Length	Largest Diameter	Wrench Flats
1/8	BST-N1M	0.02	ST-N1M	0.02	SST-N1M	0.02	1.04	0.51	0.44
1/4	BST-N2M	0.06	ST-N2M	0.05	SST-N2M	0.05	1.53	0.65	0.56
3/8	BST-N3M	0.08	ST-N3M	0.07	SST-N3M	0.08	1.69	0.79	0.69
1/2	BST-N4M	0.15	ST-N4M	0.13	SST-N4M	0.13	1.94	1.01	0.88
3/4	BST-N6M	0.23	ST-N6M	0.21	SST-N6M	0.22	2.19	1.23	1.06
1	BST-N8M	0.46	ST-N8M	0.43	SST-N8M	0.43	2.51	1.59	1.38
1-1/4	BST-N10M	0.96	-	-	-	-	2.85	2.17	1.88
1-1/2	BST-N12M	1.46	-	-	-	-	3.25	2.45	2.13



Parker Water Service Quick Couplings add convenience and efficiency wherever water hoses are frequently connected and disconnected. The durable 4-ball locking mechanism provides a secure connection.

Features:

- Brass and stainless steel construction
- Nitrile seals

Applications include:

- Garden hoses
- Wash down systems
- Mobile water tank lines

Specifications			
Body Size	Rated Pressure (psi)	Rated Flow (gpm)	Temperature Range (std seals)
3/4	200	28	-40° to +250° F

Coupler					
Body Size	Coupler Part Number	Port End	Length	Largest Diameter	Weight (lbs.)
3/4	1163-60	3/4-11 1/2 NH	1.16	1.21	0.12

Nipple					
Body Size	Nipple Part Number	Port End	Overall Length	Exposed Length	Weight (lbs.)
3/4	1163-61	3/4-11 1/2 NH	1.25	0.50	0.08

Hydraulic Quick Couplings

High Flow

HO Series

Non-Valved, High Pressure

Manual sleeve, sleeve lock



HO series couplings are high flow, high pressure, steel couplings for a wide variety of applications. Electroless nickel plating provides corrosion resistance.

Features:

- Steel material with electroless nickel plating
- Nitrile seals with PTFE back up ring
- No valving, unrestricted flow
- Standard sleeve lock guards against accidental disconnection
- Rated pressures up to 15,000 psi

Applications:

- Paper and pulp processing
- Refinery systems
- Testing systems

Specifications

Body Size	1/4	3/8	1/2
Rated Pressure (PSI)	15,000	15,000	10,000
Rated Flow (GPM)	3	6	12
Temperature Range (std seals)	-40° to +250°F		

Couplers



Body Size	Part Number	Thread Size	Overall Length	Largest Diameter	Wrench Flats	Weight (lbs.)	Dust Plug Rubber
1/4	HO-251-4FP	1/4-18 NPTF	1.67	1.06	0.94	0.24	TR-37
3/8	HO-371-6FP	3/8-18 NPTF	1.67	1.06	0.94	0.22	TR-37
1/2	HO-501-8FP	1/2-14 NPTF	2.03	1.62	1.25	0.52	DP-50

Optional Seal Materials:

Code	Description	Part Number Example
suffix -E5	Ethylene Propylene seal material- EPR (Couplers)	HO-371-6FP-E5
suffix -E4	Fluorocarbon seal material (Couplers)	HO-371-6FP-E4
suffix -E12	Neoprene seal material (Couplers)	HO-371-6FP-E12

To select proper seal materials, see Fluid Compatibility Chart or contact QCD Contact QCD for availability..

Nipples



Body Size	Part Number	Thread Size	Overall Length	Exposed Length	Largest Diameter	Wrench Flats	Weight (lbs.)	Dust Plug Rubber
1/4	HO-252-4FP	1/4-18 NPTF	1.40	0.66	0.94	0.81	0.10	TR-37
3/8	HO-372-6FP	3/8-18 NPTF	1.44	0.70	1.08	0.94	0.12	TR-37
1/2	HO-502-8FP	1/2-14 NPTF	2.03	0.86	1.30	1.12	0.26	DP-50





Performance Moldmate Series (1/4", 3/8", 1/2")
Test Fluid: Water (Straight Coupler)

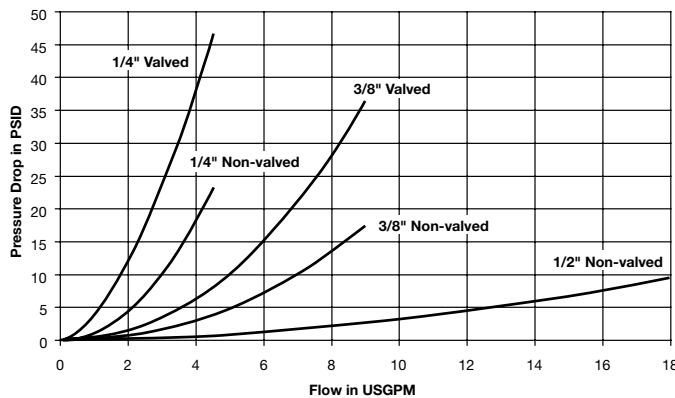

Guidelines for Selection and Use:

Non-valved couplers provide maximum flow for efficient cooling. Valved couplers shut off automatically when disconnected. Valved couplers can be used with either valved or non-valved nipples. A valved nipple, however, must be used with a valved coupler.

Moldmate couplings are rated for 200 psi max pressure. Most thermoplastic and thermoset heat transfer systems have pumps which provide relatively high flow rates at low pressures. Water and water glycol systems usually have capacities ranging from 10 to 40 gpm with most from 10 to 15 gpm. Normal medial opening pressures are 20 to 60 psi for these systems. Heat transfer systems using oil generally operate from 10 to 30 psi. However, their flow rates are usually much higher, requiring the total volume of oil to be circulated at least once per minute.

The number of hose connections in a single mold system results in a cumulative pressure drop. Please note the Pressure Drop vs. Flow Rate chart provided, to select the appropriate size.

Temperature is another important consideration. Parker Moldmate couplings with the standard silicone seal have a temperature capability of -90° to +400°F. Rapid deterioration of the seal and leakage may result if used beyond these limits.

External conditions of temperature, corrosive atmospheres, and other abnormalities may affect coupling performance and must be considered when selection is made. Consult QCD with questions.

Moldmate series couplings are specifically designed for connecting coolant lines to molds and dies on injection molding machinery and die casting equipment. These couplings significantly reduce downtime, by providing a quick and easy way to connect and disconnect lines during mold changes.

Features:

- Rated pressure is 200 psi
- Valved and unvalved options. Valved couplers have silver colored sleeves
- Brass material with standard silicone interface seals are compatible with water and water glycol fluids. Valved versions have a fluorocarbon seal on the poppet.
- Optional fluorocarbon seal for use with oil based media
- Short nipples can be installed recessed below the mold surface enabling more efficient storage and protecting the nipple from damage
- Standard and Push-Lok hose barb ends are available in straight, 45 or 90 degree configurations
- Manual sleeve operation
- Extension nipples are offered in several lengths

Applications:

- Mold coolant lines
- Die casting equipment

Special Order Information:

Standard seal material is Silicone and is compatible with water and water glycol fluids commonly used in heat transfer systems. Fluorocarbon seals are available for use with oil-based media. To specify a Fluorocarbon seal, add the suffix "Y" to the standard moldmate part number, thus: PC206Y.

Specifications			
Body Size	1/4	3/8	1/2
Rated Pressure (psi)	200		
Rated Flow (gpm)	3	6	12

Material	Temperature Range
Standard Silicone seal	-20° to +400° F
*Optional Fluorocarbon seal	-15° to +400° F

* For use with oil based media only



B Hydraulics

Couplers - Straight



Push-Lok Hose Barb



Standard Hose Barb

Body Size	Part Number Brass Non-Valved	Weight (lb.)	Part Number Brass Valved	Weight (lb.)	Hose I.D.	Overall Length	Non-Valved		Valved	
							Largest Diameter	Overall Length	Largest Diameter	Wrench Flats
1/4	PC204	0.10	PC204AV	0.10	1/4	1.87	0.63	2.67	0.71	0.63
1/4	PC204-BP*	0.10	PC204AV-BP	0.10	1/4	1.89	0.63	2.52	0.71	0.63
1/4	PC205	0.09	PC205AV	0.10	5/16	1.87	0.63	2.67	0.71	0.63
1/4	PC206	0.09	PC206AV	0.10	3/8	1.87	0.63	2.67	0.71	0.63
1/4	PC206-BP*	0.11	PC206AV-BP	0.13	3/8	2.04	0.63	2.70	0.71	0.63
3/8	PC306	0.24	PC306V	0.27	3/8	3.01	0.96	3.17	1.01	0.88
3/8	PC306-BP*	0.26	PC306V-BP	0.29	3/8	3.15	0.96	3.31	1.01	0.88
3/8	PC308	0.25	PC308V	0.28	1/2	3.15	0.96	3.17	1.01	0.88
3/8	PC308-BP*	0.25	PC308V-BP	0.03	1/2	3.27	0.96	3.43	1.01	0.88
1/2	PC504	0.46	NA	-	1/2	3.55	1.30			-
1/2	PC504-BP*	0.50	NA	-	1/2	3.68	1.21			-
1/2	PC506	0.48	NA	-	3/4	3.80	1.21			-
1/2	PC506-BP*	0.52	NA	-	3/4	3.80	1.21			-

NA = Not Available

Couplers - 45 Degree



Push-Lok Hose Barb



Standard Hose Barb

Body Size	Part Number Brass Non-Valved	Weight (lb.)	Part Number Brass Valved	Weight (lb.)	Hose I.D.	Overall Length	Non-Valved		Valved		
							Largest Diameter	Wrench Flats	Overall Length	Largest Diameter	Wrench Flats
1/4	PC224	0.13	PC224AV	0.13	1/4	2.67	0.71	0.56	2.87	0.71	0.63
1/4	PC224-BP*	0.13	PC224AV-BP	0.14	1/4	2.57	0.71	0.56	2.77	0.71	0.63
1/4	PC226	0.13	PC226AV	0.14	3/8	2.71	0.71	0.56	2.91	0.71	0.63
1/4	PC226-BP*	0.26	PC226AV-BP	0.17	3/8	2.74	0.71	0.56	2.94	0.71	0.63
3/8	PC326	0.36	PC326V	0.36	3/8	3.65	0.96	0.88	3.65	1.01	0.88
3/8	PC326-BP*	0.34	PC326V-BP	0.36	3/8	3.75	0.96	0.88	3.75	1.01	0.88
3/8	PC328	0.36	PC328V	0.36	1/2	3.69	0.96	0.88	3.69	1.01	0.88
3/8	PC328-BP*	0.34	PC328V-BP	0.40	1/2	3.88	0.96	0.88	3.88	0.96	0.88
1/2	PC524	0.74	NA	-	1/2	4.18	1.21	1.12			-
1/2	PC524-BP*	0.78	NA	-	1/2	4.28	1.21	1.12			-
1/2	PC526	0.76	NA	-	3/4	4.56	1.21	1.12			-
1/2	PC526-BP*	0.80	NA	-	3/4	4.56	1.21	1.12			-

* Suffix BP in part number denotes Push-Lok hose barb. Without suffix denotes standard hose barb.

Push-Lok hose barbs are designed for use with Parker Push-Lok hose and do not require clamps.

Valved Couplers can be used with either non-valved or valved nipples.





Couplers - 90 Degree



Push-Lok Hose Barb



Standard Hose Barb

Body Size	Part No. Brass Non-Valved	Weight (lb.)	Part No. Brass Valved (silver sleeve)	Weight (lb.)	Hose I.D.	Overall Length	Wrench Flats	Largest Diameter	Overall Length	Wrench Flats	Largest Diameter
						Non-Valved			Valved		
1/4	PC214	0.13	PC214AV	0.14	1/4	1.78	0.56	0.71	1.98	0.63	0.71
1/4	PC214-BP*	0.14	PC214AV-BP	0.14	1/4	1.78	0.56	0.71	1.98	0.63	0.71
1/4	PC215	0.13	PC215AV	0.14	5/16	1.78	0.56	0.71	1.98	0.63	0.71
1/4	PC216	0.14	PC216AV	0.15	3/8	1.78	0.56	0.71	1.98	0.63	0.71
1/4	PC216-BP*	0.16	PC216AV-BP	0.17	3/8	1.80	0.56	0.71	2.00	0.63	0.71
3/8	PC316	0.31	PC316V	0.31	3/8	2.78	0.88	0.96	2.78	0.88	0.96
3/8	PC316-BP*	0.37	PC316V-BP	0.37	3/8	2.78	0.88	0.96	2.78	0.88	0.96
3/8	PC318	0.33	PC318V	0.35	1/2	2.78	0.88	0.96	2.78	0.88	0.96
3/8	PC318-BP*	0.37	PC318V-BP	0.39	1/2	2.80	0.88	0.96	2.80	0.88	0.96
1/2	PC514	0.79	NA	-	1/2	3.50	1.12	1.21		-	
1/2	PC514-BP*	0.83	NA	-	1/2	3.50	1.12	1.21		-	
1/2	PC516	0.80	NA	-	3/4	3.50	1.12	1.21		-	
1/2	PC516-BP*	0.84	NA	-	3/4	3.50	1.12	1.21		-	

* Suffix BP in part number denotes Push-Lok hose barb. Without suffix denotes standard hose barb.
Push-Lok hose barbs are designed for use with Parker Push-Lok hose and do not require clamps.
Valved Couplers can be used with either non-valved or valved nipples.

Sub Assemblies and Individual Replacement Parts

Non-valved Sub-assembly (Brass Sleeve)



Body Size	Part No. Brass Non-Valved	Weight (lb.)	Thread Size	Length	Largest Diameter	Wrench Flats
1/4	P208-01A	0.07	1/8-27 NPTF	1.15	0.71	0.56
3/8	P308-01A	0.21	1/4-18 NPTF	1.84	0.96	0.88
3/8	P308-01A-HF	0.20	3/8-18 NPTF	1.84	0.96	0.88
1/2	PC500	0.34	1/2-14 NPTF	2.02	1.21	1.12

Valved Sub-assembly (Silver Colored Sleeve)





Bodies are designed for use with a valve and spring retained by a male pipe fitting (i.e. hose barb). Valve, valve spring, and end fitting are not included with sub-assembly and must be ordered separately.

Body Size	Part No. Brass Valved	Weight (lb.)	Thread Size	Length	Largest Diameter	Wrench Flats
1/4	P201-01A	0.07	1/8-27 NPTF	1.35	0.71	0.56
3/8	P301-01A	0.21	1/4-18 NPTF	1.84	0.96	0.88



Sub Assemblies and Individual Replacement Parts

Valves (for Valved Sub-assembly)			Valve Springs (for Valved Sub-assembly)		
					
Body Size	Part Number	Material	Body Size	Part Number	Material
1/4	3613001	Brass	1/4	7820123	Stainless
3/8	P300-11S	Brass	3/8	P300-6	Stainless

Replacement Seals (for both Valved and Non-valved)					
					
Body Size	Part Number	Material	Body Size	Part Number	Material
1/4	P200-9A	* Silicone	1/4	P200-9AY	* Fluorocarbon
3/8	P300-9A	* Silicone	3/8	P300-9AY	* Fluorocarbon
1/2	P500-9A	* Silicone	1/2	P500-9AY	* Fluorocarbon

* Note: Bulk seals are not returnable.

Assembly Instruction Sheet (for all sizes & configurations)
Part Number
9090065

B Hydraulics



Nipples - Female Pipe Thread



Body Size	Part No. Brass	Weight (lb.) Brass	Part No. Steel	Weight (lb.) Steel	Thread Size	Overall Length	Exposed Length**	Wrench Flats	Largest Diameter
1/4	BPN251F	0.02	PN251F	0.02	1/8-27 NPTF	0.97	0.58	0.50	0.58
1/4	BPN252F	0.05	PN252F	0.04	1/4-18 NPTF	1.28	0.89	0.63	0.72
1/4	BPN253F	0.08	PN253F	0.08	3/8-18 NPTF	1.41	1.02	0.75	0.87
3/8	BPN352F	0.05	PN352F	0.05	1/4-18 NPTF	1.48	0.88	0.63	0.72
3/8	BPN353F	0.07	PN353F	0.06	3/8-18 NPTF	1.58	0.98	0.75	0.87

Nipples - Male Pipe Thread



Body Size	Part No. Brass	Weight (lb.) Brass	Part No. Steel	Weight (lb.) Steel	Thread Size	Overall Length	Exposed Length**	Wrench Flats	Largest Diameter	Install Recess Diameter	Depth
1/4	PN250	0.02	-	-	1/16-27 NPTF	0.94	0.54	0.44	0.51	0.69	0.69
1/4	PN251	0.02	PN251S	0.02	1/8-27 NPTF	0.94	0.54	0.44	0.51	0.69	0.69
1/4	PN252	0.03	PN252S	0.03	1/4-18 NPTF	1.13	0.74	0.56	0.67	0.84	0.94
1/4	PN253	0.05	PN253S	0.05	3/8-18 NPTF	1.19	0.79	0.69	0.79	1.00	0.94
3/8	PN352	0.04	PN352S	0.04	1/4-18 NPTF	1.34	0.74	0.56	0.65	1.00	1.09
3/8	PN353	0.06	PN353S	0.06	3/8-18 NPTF	1.38	0.78	0.69	0.79	1.00	1.13
3/8	PN354	0.12	NA	-	1/2-14 NPTF	1.59	0.99	0.88	1.01	1.19	1.25
1/2	PN553	0.12	NA	-	3/8-18 NPTF	1.53	0.77	0.88	1.01	1.25	1.34
1/2	PN554	0.11	NA	-	1/2-14 NPTF	1.70	0.94	0.88	1.01	1.25	1.50
1/2	PN556	0.16	NA	-	3/4-14 NPTF	1.75	0.99	1.06	1.23	1.50	1.56

Valved Nipple



Body Size	Part Number Brass	Thread Size	Overall Length	**Exposed Length	Largest Diameter	Wrench Flats	Weight (lb.)
1/4	BPV252*	1/4-18 NPTF	1.21	0.82	0.67	.56	0.03
3/8	BPV353*	3/8-18 NPTF	1.48	0.88	0.79	.69	0.07

*Valved Nipple must be used with Valved Coupler.

**This dimension represents the portion of the nipple that is exposed when inserted into a moldmate coupler.

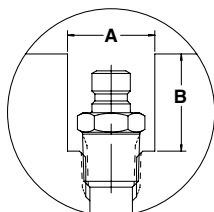

Install Recess Diameter	Depth
0.84	0.94
1.00	1.23



Nipples - Moldmate Extension



Body Size	Part Number Brass	Weight (lb.) Brass	Thread Size	Overall Length	Length	Wrench Flats	Largest Diameter
1/4	PN250-25	0.04	1/16-27 NPTF	2.50	.69	3/8	0.43
1/4	PN250-40	0.06	1/16-27 NPTF	4.00	.81	3/8	0.43
1/4	PN250-55	0.09	1/16-27 NPTF	5.50	.81	3/8	0.43
1/4	PN251-25	0.06	1/8-27 NPTF	2.50	.69	7/16	0.51
1/4	PN251-40	0.10	1/8-27 NPTF	4.00	1.00	7/16	0.51
1/4	PN251-55	0.13	1/8-27 NPTF	5.50	1.00	7/16	0.51
1/4	PN251-70	0.17	1/8-27 NPTF	7.00	1.00	7/16	0.51
1/4	PN251-85	0.21	1/8-27 NPTF	8.50	1.00	7/16	0.51
1/4	PN252-25	0.09	1/4-18 NPTF	2.50	.88	9/16	0.65
1/4	PN252-40	0.15	1/4-18 NPTF	4.00	1.25	9/16	0.65
1/4	PN252-55	0.22	1/4-18 NPTF	5.50	1.25	9/16	0.65
1/4	PN252-70	0.27	1/4-18 NPTF	7.00	1.25	9/16	0.65
1/4	PN252-85	0.33	1/4-18 NPTF	8.50	1.25	9/16	0.65
3/8	PN351-25	0.07	1/8-27 NPTF	2.50	.88	9/16	0.65
3/8	PN351-40	0.11	1/8-27 NPTF	4.00	1.00	9/16	0.65
3/8	PN351-55	0.15	1/8-27 NPTF	5.50	1.00	9/16	0.65
3/8	PN351-70	0.18	1/8-27 NPTF	7.00	1.00	9/16	0.65
3/8	PN351-85	0.22	1/8-27 NPTF	8.50	1.00	9/16	0.65
3/8	PN352-25	0.09	1/4-18 NPTF	2.50	.88	9/16	0.65
3/8	PN352-40	0.15	1/4-18 NPTF	4.00	1.25	9/16	0.65
3/8	PN352-55	0.21	1/4-18 NPTF	5.50	1.25	9/16	0.65
3/8	PN352-70	0.27	1/4-18 NPTF	7.00	1.25	9/16	0.65
3/8	PN352-85	0.33	1/4-18 NPTF	8.50	1.25	9/16	0.65
3/8	PN353-25	0.12	3/8-18 NPTF	2.50	1.00	11/16	0.79
3/8	PN353-40	0.20	3/8-18 NPTF	4.00	1.25	11/16	0.79
3/8	PN353-55	0.28	3/8-18 NPTF	5.50	1.25	11/16	0.79
3/8	PN353-70	0.37	3/8-18 NPTF	7.00	1.25	11/16	0.79
3/8	PN353-85	0.45	3/8-18 NPTF	8.50	1.25	11/16	0.79

B Hydraulics



DM Series are special purpose miniature couplings that offer double shut-off and push to connect operation in a small envelope. The 1/8 inch brass couplings are nickel plated with standard fluorocarbon seals.

Features:

- Rated pressure is 250 psi
- Double shut-off valving
- Fluorocarbon seals
- Standard end configurations are female and male pipe thread

Applications:

- Dental equipment
- Lubrication lines
- Fluid transfer
- Coolant lines

Performance

DM Series (1/8")
Test Fluid: Water

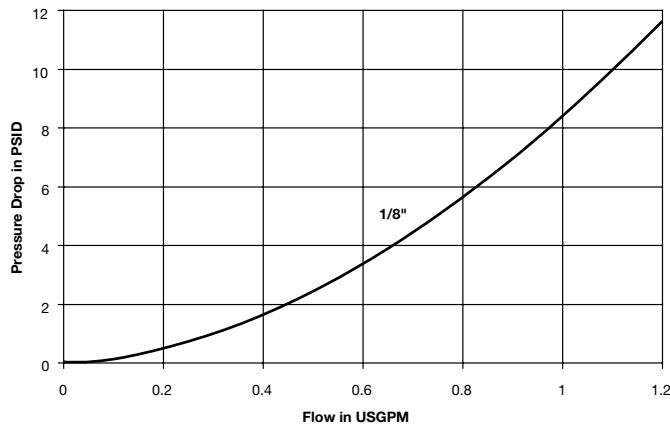

Specifications

Body Size (in.)	1/8
Rated Pressure (psi)	250
Locking Device (balls)	5
Rated Flow (gpm)	0.8
Temperature Range	-15°F to +400°F

How To Order

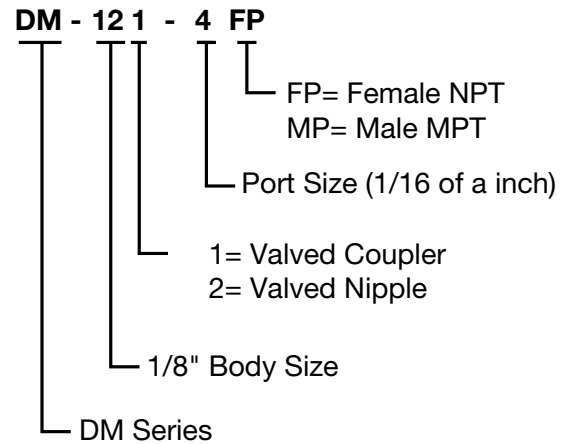



Couplers - Female Pipe Thread



Body Size	Part Number	Weight (lb.)	Thread Size	Overall Length	Largest Diameter	Wrench Flats
1/8	DM-121-2FP	0.06	1/8-27 NPTF	1.42	0.63	0.55
1/8	DM-121-4FP	0.10	1/4-18 NPTF	1.81	0.78	0.67

Couplers - Male Pipe Thread



Body Size	Part Number	Weight (lb.)	Thread Size	Overall Length	Largest Diameter	Wrench Flats
1/8	DM-121-2MP	0.06	1/8-27 NPTF	1.50	0.63	0.55
1/8	DM-121-4MP	0.07	1/4-18 NPTF	1.61	0.63	0.55

Nipples - Female Pipe Thread



Body Size	Part Number	Weight (lb.)	Thread Size	Overall Length	Exposed Length*	Largest Diameter	Wrench Flats
1/8	DM-122-2FP	0.05	1/8-27 NPTF	1.56	1.03	0.63	0.55
1/8	DM-122-4FP	0.09	1/4-18 NPTF	1.97	1.44	0.78	0.67

* This dimension represents the portion that is exposed when a nipple is inserted into a Parker DM Series coupler.

Nipples - Male Pipe Thread



Body Size	Part Number	Weight (lb.)	Thread Size	Overall Length	Exposed Length*	Largest Diameter	Wrench Flats
1/8	DM-122-2MP	0.05	1/8-27 NPTF	1.65	1.12	0.63	0.55
1/8	DM-122-4MP	0.06	1/4-18 NPTF	1.77	1.24	0.63	0.55

* This dimension represents the portion that is exposed when a nipple is inserted into a Parker DM Series coupler.

When ordering Parker coupler bodies and nipples, please state the part number of each type of coupler body and each type of nipple desired. List coupler bodies and nipples as separate items rather than in combinations. Be sure to double check thread or hose sizes of items required.

Many of Parker's coupling products are available with unique non-standard options well suited to very specific applications. Examples of unusual end use applications might include: high temperatures (above 250° F), extremely caustic/corrosive solutions passing through the coupling, external/environmental corrosion situations, or other high wear and tear situations such as dragging the product along the ground. Please see the Fluid Compatibility Chart at the end of the catalog for a guide in selecting material for various media. It is always recommended that the Quick Coupling Division be contacted with any questions concerning specific product application needs.

Typically, a prefix or suffix is added to the base part number to specify a non-standard O-ring seal, or special option such as a sleeve lock. The Optional Seals Suffix chart illustrates the designations.

Optional Features

- Prefix "HD" for Heavy Duty Nipple
- Suffix "SL" for Coupler Sleeve-Lok
- Suffix "P" for Poppet Valve
- Suffix "BP" for Push-Lok Hose Barb
- Suffix "VA" for Valve Actuator

Optional Seals Suffix*

No suffix is required when ordering products with the standard Nitrile seals. When specifying an optional seal, refer to the following chart to determine the appropriate suffix.

Coupling Series	Ethylene Propylene	Fluoro-carbon	Neoprene	Perfluoro-elastomer
60 Series	W	Y	Z	***
6600 Series	W	Y	Z	***
SM Series	E5	E4	E12	***
HP Series	E5	E4	E12	***
4000 Series	W	Y	Z	N/A
4200 Series	W	Y	Z	N/A
NS Series	E5	E4	N/A	***
FF Series Std. is E4 ⁹	E5	E4	N/A	***
FH Series	E5	E4	N/A	***
FS Series	E5	STD	E12	***
6100 Series	W	Y	Z	N/A
5000 Series	W	Y	Z	N/A
8200 Series	W	Y	Z	N/A
9200 Series	W	Y	Z	N/A
3000 Series	Available with Polyurethane only (no suffix needed)			
TC Series	Available with Fluorocarbon only (no suffix needed)			
1141 Series	Available with Polyurethane only (no suffix needed)			
ST Series	W	Y	Z	
Water Service	Available with Nitrile only			
HO Series	E5	E4	E12	N/A
Moldmate Series Std. is Silicone	N/A	Y**	N/A	N/A

N/A = Not Available

STD = Standard (No Suffix Needed)

* To select proper seal materials, see Fluid Compatibility Chart in Appendices section, or contact your Parker Quick Coupling Distributor.

** Fluorocarbon seal available for use only with oil based media, not water glycol.

*** Contact QCD for Perfluoroelastomer seal options.



Description

These popular Quick Coupling Key Chains are constructed of anodized aluminum and are available in an array of colors. The original design, nickel plated version can be ordered as well.

Part Number	Sleeve Color
KEY-BK	Black
KEY-BU	Blue
KEY-GR	Green
KEY-RD	Red
KEY-CL	Clear
KEY-NI	Old style nickel plated



aerospace
 climate control
 electromechanical
 filtration
 fluid & gas handling
 hydraulics
 pneumatics
 process control
 sealing & shielding



Quick Coupling Products

Quick Couplings, Swivels, Valves,
 Diagnostic Equipment
 Catalog 3800 USA | February 2014



ENGINEERING YOUR SUCCESS.

Quick Coupling Division Locations



Minneapolis, MN



Grantsburg, WI



Chetek, WI



Union City, PA

WARNING

FAILURE OR IMPROPER SELECTION OR IMPROPER USE OF THE PRODUCTS DESCRIBED HEREIN OR RELATED ITEMS CAN CAUSE DEATH, PERSONAL INJURY AND PROPERTY DAMAGE.

- This document and other information from Parker-Hannifin Corporation, its subsidiaries and authorized distributors provide product or system options for further investigation by users having technical expertise.
- The user, through its own analysis and testing, is solely responsible for making the final selection of the system and components and assuring that all performance, endurance, maintenance, safety and warning requirements of the application are met. The user must analyze all aspects of the application, follow applicable industry standards, and follow the information concerning the product in the current product catalog and in any other materials provided from Parker or its subsidiaries or authorized distributors.
- To the extent that Parker or its subsidiaries or authorized distributors provide component or system options based upon data or specifications provided by the user, the user is responsible for determining that such data and specifications are suitable and sufficient for all applications and reasonably foreseeable uses of the components or systems.

Offer of Sale

The items described in this document are hereby offered for sale by Parker Hannifin Corporation, its subsidiaries or its authorized distributors. This offer and its acceptance are governed by the provisions stated in the "Offer of Sale."

Table of Contents

- Pneumatic Quick Couplings.....Section A**
- Hydraulic Quick Couplings.....Section B**
- Thermoplastic Couplings.....Section C**
- Swivels.....Section D**
- Valves.....Section E**
- Diagnostic Products.....Section F**

- Appendices:**
- Fluid Compatibility Chart.....I**
- Safety Guide.....VI**
- Offer of Sale.....IX**
- Glossary of Terms.....X**





Thermoplastic Quick Couplings

Coupling Selection Guide	C-2
PPM -PPL Series	C-3
Couplers	C-3, C-4
Nipples	C-4, C-5
PPA Series	C-6
Couplers	C-6
Nipples	C-6
Spectrum Series	C-7
Couplers	C-8, C-9
Nipples	C-8 to C-10
PF Series	C-11
Couplers	C-11
Nipples	C-12
Ordering Information.....	C-13

Thermoplastic Coupling Selection Guide

Series	Valving	Coupler Style	Body Size (in.)	Material	Locking Mechanism	Std. Seal Material	Temp. Range	Rate Pressure
Non-Spill Bulk Transfer								
PF Series	Flush Face Non-Spill	Push-to-connect	1/2, 1 & 2	Polypropylene/Stainless	Pawl Lock	Fluorocarbon	+40° to +140° F	30 to 100 PSI
General Purpose								
Spectrum™ Series	Valved or Unvalved	Push-to-connect	1/8 & 3/8	Acetal 316 SS	Finger Lock	Nitrile	0° to +180° F	0 to 145 PSI
Spectrum™ Series	Valved or Unvalved		1/8 & 3/8	PVDF/SS 316 SS*	Finger Lock	Fluorocarbon	0° to +250° F	0 to 115 PSI
Spectrum™ Series	Valved or Unvalved		3/8	PVDF/PEEK™*	Finger Lock	Fluorocarbon	0° to +250° F	15 to 115 PSI
Push Button Release								
PPM Series	Valved or Unvalved	Push-to-connect	1/8	Acetal Copolymer/Stainless	Metal Push-Button Latch	Nitrile	-40° to +180° F	Vacuum to 120 PSIG
PPL Series	Valved or Unvalved		1/4	Acetal Copolymer/Stainless	Metal Push-Button Latch	Nitrile	-40° to +180° F	Vacuum to 120 PSIG
PPA Series	Valved or Unvalved		1/4	Acetal Copolymer/Stainless	Plastic Push-Button Latch	Nitrile	-40° to +180° F	Vacuum to 120 PSIG

*Spectrum Series PVDF material options are subject to quote from the division



Interconnects with similar metal latch push button couplings.

PPM & PPL Series Couplings are general purpose, thermoplastic couplings. The push-to-connect feature and push-button release provides simple one-handed operation. The couplers and nipples are available with or without valves and can be used in any combination. The light weight thermoplastic material resists dust. Standard seal material is Nitrile.

Applications include:

- Medical Devices
- Laboratory Equipment
- Chemical Processing
- Food and Beverage
- Industrial
- Process Equipment

PPM & PPL Series Specifications						
	Flow Capacity	Rated Pressure	Temperature	Body Material	Latch & Spring Material	Seal Material
PPM Series	1/8"	Vacuum to 120 psi	-40° to +180° F	Acetal Copolymer	Stainless Steel	Nitrile
PPL Series	1/4"		-40° to +82° C			

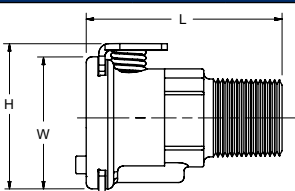
Couplers- Male Thread						
						
Body Size	Valved or Non-Valved	Port End	Part Number	L	W	H
1/8	Valved	1/8" NPT	PPM-121-2MP	1.00	0.62	0.80
1/8	Valved	1/4" NPT	PPM-121-4MP	1.10	0.62	0.80
1/8	Non-Valved	1/8" NPT	PPM-123-2MP	1.00	0.62	0.80
1/8	Non-Valved	1/4" NPT	PPM-123-4MP	1.10	0.62	0.80
1/4	Valved	1/4" NPT	PPM-251-4MP	1.15	0.75	0.93
1/4	Valved	3/8" NPT	PPM-251-6MP	1.15	0.75	0.93
1/4	Non-Valved	1/4" NPT	PPM-253-4MP	1.15	0.75	0.93
1/4	Non-Valved	3/8 NPT	PPM-253-6MP	1.15	0.75	0.93



Couplers- In-Line Hose Barb

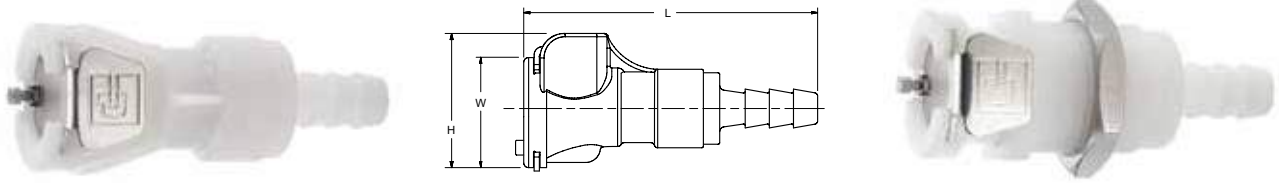

Body Size	Valved or Non-Valved	Tube I.D.	Hose Barb				Bulkhead Hose Barb with Nut			
			Part Number	L	W	H	Part Number	L	W	H
1/8	Valved	1/8"	PPM-121-2HB	1.65	0.62	0.80	PPM-121-H2HB	1.65	0.62	0.80
1/8	Valved	3/16"	PPM-121-3HB	1.80	0.62	0.80	PPM-121-H3HB	1.80	0.62	0.80
1/8	Valved	1/4"	PPM-121-4HB	1.80	0.62	0.80	PPM-121-H4HB	1.80	0.62	0.80
1/8	Non-Valved	1/8"	PPM-123-2HB	1.65	0.62	0.80				
1/8	Non-Valved	3/16"	PPM-123-3HB	1.80	0.62	0.80				
1/8	Non-Valved	1/4"	PPM-123-4HB	1.80	0.62	0.80				
1/4	Valved	1/4"	PPL-251-4HB	1.90	0.75	0.93	PPL-251-H4HB	1.88	0.75	0.93
1/4	Valved	5/16"	PPL-251-5HB	1.95	0.75	0.93				
1/4	Valved	3/8"	PPL-251-6HB	1.90	0.75	0.93	PPL-251-H6HB	1.88	0.75	0.93
1/4	Non-Valved	1/4"	PPL-253-4HB	1.90	0.75	0.93				
1/4	Non-Valved	5/16"	PPL-253-5HB	1.95	0.75	0.93				
1/4	Non-Valved	3/8"	PPL-253-6HB	1.90	0.75	0.93				

Nipples- Male Thread



Body Size	Valved or Non-Valved	Port End	Part Number	L	W	H
1/8	Valved	1/8" NPT	PPM-122-2MP	1.27	0.50	0.50
1/8	Valved	1/4" NPT	PPM-122-4MP	1.29	0.56	0.56
1/8	Non-Valved	1/8" NPT	PPM-124-2MP	1.03	0.49	0.49
1/8	Non-Valved	1/4" NPT	PPM-124-4MP	1.13	0.56	0.56
1/4	Valved	1/4" NPT	PPM-252-4MP	1.50	0.62	0.62
1/4	Valved	3/8" NPT	PPM-252-6MP	1.65	0.75	0.75
1/4	Non-Valved	1/4" NPT	PPM-254-4MP	1.26	0.62	0.62
1/4	Non-Valved	3/8" NPT	PPM-254-6MP	1.25	0.75	0.75



Nipples- In-Line Hose Barb



Body Size	Valved or Non-Valved	Tube I.D.	Hose Barb				Bulkhead Hose Barb with Nut			
			Part Number	L	W	H	Part Number	L	W	H
1/8	Valved	1/8"	PPM-122-2HB	0.97	0.55	0.55	PPM-122-H2HB	1.61	0.62	0.62
1/8	Valved	3/16"	PPM-122-3HB	1.12	0.55	0.55	PPM-122-H3HB	1.76	0.62	0.62
1/8	Valved	1/4"	PPM-122-4HB	1.12	0.55	0.55	PPM-122-H4HB	1.76	0.62	0.62
1/8	Non-Valved	1/8"	PPM-124-2HB	0.97	0.50	0.50				
1/8	Non-Valved	3/16"	PPM-124-3HB	1.12	0.50	0.50	PPM-124-H3HB	1.76	0.62	0.62
1/8	Non-Valved	1/4"	PPM-124-4HB	1.12	0.50	0.50				
1/4	Valved	1/4"	PPL-252-4HB	1.80	0.70	0.70	PPL-252-H4HB	1.87	0.74	0.74
1/4	Valved	5/16"	PPL-252-5HB	1.85	0.70	0.70				
1/4	Valved	3/8"	PPL-252-6HB	1.67	0.70	0.70	PPL-252-H6HB	1.84	0.74	0.74
1/4	Non-Valved	1/4"	PPL-254-4HB	1.25	0.62	0.62				
1/4	Non-Valved	5/16"	PPL-254-5HB	1.28	0.62	0.62				
1/4	Non-Valved	3/8"	PPL-254-6HB	1.25	0.62	0.62				

Nipples- 90° Hose Barb



Body Size	Valved or Non-Valved	Tube I.D.	Part Number	L	W	H
1/8	Valved	1/8"	PPM-122-C2HB	1.09	0.50	0.95
1/8	Valved	1/4"	PPM-122-C4HB	1.09	0.50	1.10
1/8	Non-Valved	1/8"	PPM-124-C2HB	0.86	0.50	1.10
1/8	Non-Valved	1/4"	PPM-124-C4HB	0.98	0.50	1.15
1/4	Valved	1/4"	PPL-252-C4HB	1.19	0.62	1.23
1/4	Valved	3/8"	PPL-252-C6HB	1.24	0.62	1.23
1/4	Non-Valved	1/4"	PPL-254-C4HB	1.10	0.62	1.27
1/4	Non-Valved	3/8"	PPL-254-C6HB	1.10	0.62	1.23



Interconnects with similar plastic latch push button couplings.

PPA Series Couplings are general purpose, thermoplastic couplings. The PPA couplers are push-to-connect and have a plastic latch for push-button release. With a fully plastic exterior and smooth face, they are non-marring to most surfaces. Note: Does not interchange with PPL Series.

Applications include:

- Medical Devices
- Laboratory Equipment
- Chemical Processing
- Food and Beverage
- Industrial
- Process Equipment

PPA Series Specifications

Flow Capacity	Rated Pressure	Temperature	Body & Latch Material	Springs Material	Seal Material
1/4"	Vacuum to 120 PSI	-40° to +180° F -40° to +82° C	Acetal Copolymer	Stainless Steel	Nitrile

Couplers- Hose Barb

Body Size	Tube I.D.	Valved	Part Number	L	H	Tube I.D.	Valved	Part Number	L	H
1/4	1/4"	Yes	PPA-251-4HB	2.03	0.93	1/4"	No	PPA-253-4HBSB	1.36	0.93
1/4	3/8"	Yes	PPA-251-6HB	2.04	0.93	3/8"	No	PPA-253-6HBSB	1.36	0.93

Nipples- Hose Barb

Body Size	Tube I.D.	Valved	Part Number	L	H	Tube I.D.	Valved	Part Number	L	H
1/4	1/4"	Yes	PPA-252-4HB	1.89	0.71	1/4"	No	PPA-254-4HB	1.35	0.63
1/4	3/8"	Yes	PPA-252-6HB	1.75	0.71	3/8"	No	PPA-254-6HB	1.36	0.61



Parker's Spectrum™ Series couplers are the most advanced engineered thermoplastic couplings available. Spectrum Series couplings combine compact size, high flow capability, and light weight design to meet a broad range of coupling applications. Spectrum Series can be used in many applications previously reserved for stainless steel couplings.

Features

- Excellent Chemical Compatibility
- Standard Acetal/SS Material with PVDF/SS and PVDF/PEEK™ options subject to quote
- High Flow Capacity
- Easy Push-To-Connect Operation
- Available Valved and Unvalved
- Flexible Modular Design
- Four Point 360° Locking Mechanism
- Panel Mounting Option

Applications:

- Chemical processing
- Automation equipment
- Semi-conductor industry
- Food processing

Spectrum™ Series Specifications					
	Acetal/SS (standard material) (black with black sleeve)		*PVDF/SS (translucent with white sleeve)		*PVDF/PEEK™ (translucent)
Body Size	1/8	3/8	1/8	3/8	3/8
Pressure Range	0-145 psi (0-10 bar)	0-145 psi (0-10 bar)	0-115 psi (0-8 bar)	0-115 psi (0-8 bar)	15-115 psi (0-8 bar)
Temperature Range	0° F to 180° F (-20° C to +80° C)	0° F to 180° F (-20° C to +80° C)	0° F to 250° F (-20° C to +120° C)	0° F to 250° F (-20° C to +120° C)	0° F to 250° F (-20° C to +120° C)
Rated Flow	1.5 GPM (5.6 lpm)	4.5 GPM (17 lpm)	1.5 GPM (5.6 lpm)	4.5 GPM (17 lpm)	4.5 GPM (17 lpm)
Body Material	Acetal	Acetal	PVDF	PVDF	PVDF
Spring Material	316 SS	316 SS	316 SS	316 SS	PEEK™
Seal Material	Nitrile	Nitrile	Fluorocarbon	Fluorocarbon	Fluorocarbon

*PVDF material options are subject to quote from the division

Performance

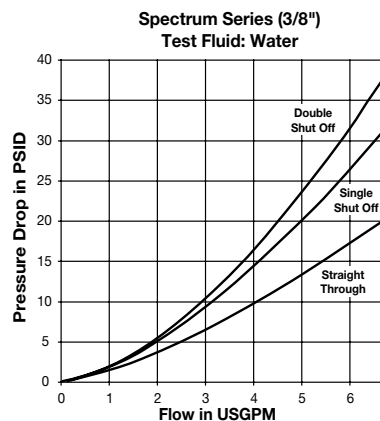
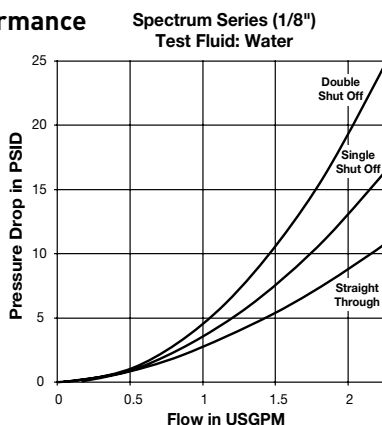

How To Order

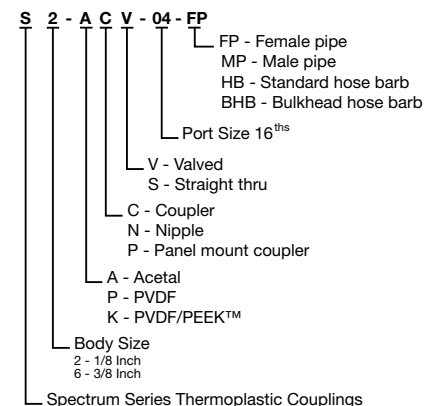

Note: Not all combinations are standard. Please contact QCD for availability, price and delivery.

Couplers- Valved, Female Pipe



Body Size	Acetal Part Number	Port NPT	Overall Length	Largest Diameter	Wrench Flats
1/8	S2-ACV-04-FP	1/4-18	2.34	.82	.67
3/8	S6-ACV-04-FP	1/4-18	2.63	1.02	.82
3/8	S6-ACV-06-FP	3/8-18	2.63	1.02	.82

Couplers- Valved, Male Pipe



Body Size	Acetal Part Number	Port NPT	Overall Length	Largest Diameter	Wrench Flats
1/8	S2-ACV-04-MP	1/4-18	2.15	.82	.67
3/8	S6-ACV-04-MP	1/4-18	2.90	1.02	.82
3/8	S6-ACV-06-MP	3/8-18	2.77	1.02	.82

Couplers- Valved, Hose Barb



Body Size	Acetal Part Number	Hose I.D.	Overall Length	Largest Diameter	Wrench Flats
1/8	S2-ACV-03-HB	3/16 (4 mm)	2.34	.82	.67
1/8	S2-ACV-04-HB	1/4 (6 mm)	2.34	.82	.67
3/8	S6-ACV-04-HB	1/4 (6 mm)	3.19	1.02	.82
3/8	S6-ACV-06-HB	3/8 (9 mm)	3.19	1.02	.82

Couplers- Valved, Bulkhead Hose Barb



Body Size	Acetal Part Number	Hose I.D.	Overall Length	Largest Diameter	Wrench Flats	Bulkhead Wrench Flats	Bulkhead Hole Diameter
1/8	S2-ACV-03-BHB	3/16 (4 mm)	2.89	.82	.67	.67	.50

Panel Mount Couplers- Valved, Female Pipe



Body Size	Acetal Part Number	Port NPT	Overall Length	Largest Diameter	Wrench Flats	Bulkhead Wrench Flats	Bulkhead Hole Diameter
1/8	S2-APV-04-FP	1/4-18	2.16	1.10	.67	1.06	1.00

C Thermoplastics

Panel Mount Couplers- Valved, Hose Barb



Body Size	Acetal Part Number	Hose I.D.	Overall Length	Largest Diameter	Wrench Flats	Bulkhead Wrench Flats	Bulkhead Hole Diameter
1/8	S2-APV-04-HB	1/4 (6 mm)	2.34	1.10	.67	1.06	1.00

Nipples- Unvalved, Female Pipe



Body Size	Acetal Part Number	Port NPT	Overall Length	Largest Diameter	Wrench Flats
1/8	S2-ANS-04-FP	1/4-18	1.18	.76	.67
3/8	S6-ANS-06-FP	3/8-18	1.52	.91	.83

Nipples- Unvalved, Male Pipe



Body Size	Acetal Part Number	Port NPT	Overall Length	Largest Diameter	Wrench Flats
1/8	S2-ANS-04-MP	1/4-18	1.24	.76	.67
3/8	S6-ANS-06-MP	3/8-18	1.64	.91	.83

Nipples- Unvalved, Hose Barb



Body Size	Acetal Part Number	Hose I.D.	Overall Length	Largest Diameter
1/8	S2-ANS-03-HB	3/16 (4 mm)	1.26	.34
1/8	S2-ANS-04-HB	1/4 (6 mm)	1.26	.34
3/8	S6-ANS-04-HB	1/4 (6 mm)	1.86	.71
3/8	S6-ANS-06-HB	3/8 (9 mm)	1.87	.71

Nipples- Unvalved, Bulkhead Hose Barb



Body Size	Acetal Part Number	Hose I.D.	Overall Length	Wrench Flats	Largest Diameter	Bulkhead Wrench Flats	Bulkhead Hole Diameter
1/8	S2-ANS-03-BHB	3/16 (4 mm)	1.97	.55	.64	.55	.44
1/8	S2-ANS-04-BHB	1/4 (6 mm)	1.97	.55	.77	.67	.44

Nipples- Valved, Female Pipe



Body Size	Acetal Part Number	Port NPT	Overall Length	Largest Diameter	Wrench Flats
1/8	S2-ANV-04-FP	1/4-18	1.80	.76	.67
3/8	S6-ANV-04-FP	1/4-18	2.02	.91	.83
3/8	S6-ANV-06-FP	3/8-18	2.02	.91	.83

Nipples- Valved, Male Pipe



Body Size	Acetal Part Number	Port NPT	Overall Length	Largest Diameter	Wrench Flats
1/8	S2-ANV-04-MP	1/4-18	1.80	.76	.67
3/8	S6-ANV-04-MP	1/4-18	2.24	.91	.83
3/8	S6-ANV-06-MP	3/8-18	2.16	.91	.83

Nipples- Valved, Hose Barb



Body Size	Acetal Part Number	Hose I.D.	Overall Length	Largest Diameter	Wrench Flats
1/8	S2-ANV-03-HB	3/16 (4 mm)	1.80	.76	.67
1/8	S2-ANV-04-HB	1/4 (6 mm)	1.80	.76	.67
3/8	S6-ANV-04-HB	1/4 (6 mm)	2.59	.91	.82
3/8	S6-ANV-06-HB	3/8 (9 mm)	2.59	.91	.82

Nipples- Valved, Bulkhead Hose Barb



Body Size	Acetal Part Number	Hose I.D.	Overall Length	Largest Diameter	Wrench Flats	Bulkhead Wrench Flats	Bulkhead Hole Diameter
1/8	S2-ANV-03-BHB	3/16 (4 mm)	2.35	.76	.67	.55	.44

C Thermoplastics



The Parker PF Series Dry Disconnect couplings virtually eliminate fluid loss upon disconnection and are designed help meet the demand for closed system transfer and dispensing of chemicals and fluids with minimal environmental contamination. They can be used with concentrated or diluted industrial chemicals, fertilizers, herbicides, insecticides, fungicides or pesticides when transferring from bulk storage tanks, returnable containers, applicators, etc.

Features:

The PF Series 2" body size is ideal for large bulk transfer of fluids and eliminating fluid spillage when connecting and disconnecting.

- Rugged Glass filled Polypropylene construction for chemical compatibility and reduced cost.
- Push-to-connect design.
- Flush face valves exhibit minimal spillage upon connect or disconnect and air inclusion on connect, and enables ease of cleaning.
- PTFE coated Fluorocarbon tank gasket for improved chemical compatibility.
- 1" coupler has non-wetted springs.

Performance

PF (1/2", 1", 2")
Test Fluid: Water

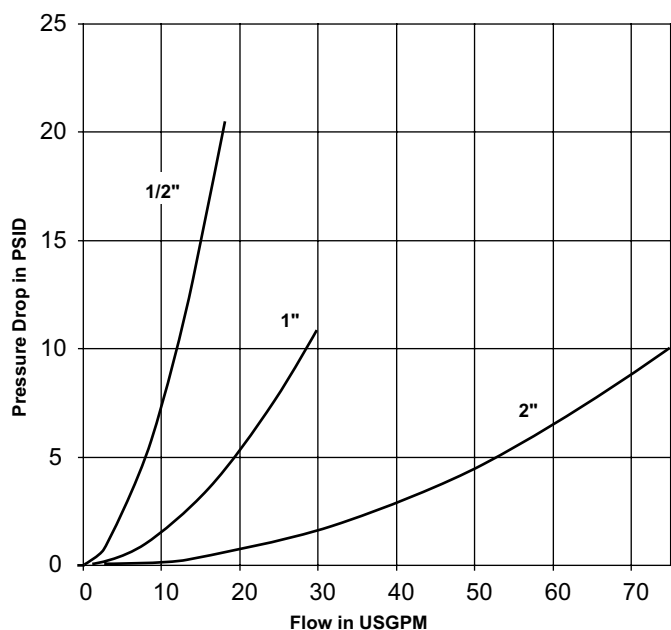

Applications include:

- Chemical Dispensing Systems
- Spray Application Equipment
- Mini Bulk Tanks
- Replacement for Banjo Style Camlok Fittings & Ball Valves
- Bulk Transfer Barrels

PF Series Specifications

Body Size	1/2	1	2
Materials: Body Springs Seals	Polypropylene 316 Stainless Steel Fluorocarbon ⁽¹⁾		
Rated Pressure (at 68° F)	100 PSI	60 PSI	100 PSI
Rated Flow	12 GPM	20 GPM	50 GPM
Pressure Drop at Rated Flow	11.3 PSI	3.4 PSI	4 PSI
Force to Connect	32 lbs.	41 lbs.	54 lbs.
Force to Disconnect	12 lbs.	17 lbs.	17 lbs.
Operating Temperature	+40° to +140° F		
Storage Temperature	-20° to +140° F		
Maximum Spillage	0.14 ml	1 ml	9 ml
per Disconnect	.01 cu. in.	.06 cu. in.	.5 cu. in.
Vacuum Rating	27.4 Hg	Contact QCD	Contact QCD (1)

(1) Also available in EPDM, Nitrile, Neoprene, Perfluoroelastomer



Couplers - Female Threads



Body Size	Part Number	Port* Thread	Overall Length	Largest Diameter	Wrench Flats	Weight
1/2	PF-501-8FP	1/2" NPT	3.02	1.88	1.38	0.18
1	PF-1001-16FP	1" NPT	3.99	3.00	1.99	0.53
2	PF-2001-32FP	2" NPT	6.63	5.00	-	1.75

* Female NPT Threads standard. For other port options contact the division.

Nipples - Female Threads



Body Size	Part Number	Port* Thread	Tank Mount Thread	Overall Length	Largest Diameter	Wrench Flats	Weight
1/2	PF-502-8FP	1/2" NPT	None	2.96	1.33	1.24	0.09
1	PF-1002-16FP	1" NPT	None	3.92	2.20	1.87	0.26
2	PF-2002-32FP	2" NPT	None	5.71	3.55	-	0.75

* Female NPT Threads standard. For other port options contact the division.

Nipples- Tank Mount



Body Size	Part Number	Port* Thread	Tank Mount Thread	Overall Length	Largest Diameter	Wrench Flats	Weight
1	PF-1002-32MB	1" NPT	Modified Buttress	3.92	2.75	1.87	0.3
1	PF-1002-32MP	1" NPT	Modified NPS	3.92	2.75	1.87	0.3

* Female NPT Threads standard. For other port options contact the division.



Dust Cap and Plugs

Body Size	Coupler Dust Cap Part Number	Nipple Dust Cap Part Number	Material
1/2	FR-501	FR-502	Synthetic Rubber
1	None	PFR-1002	Ethylene Propylene
1	None	PFR-1002-NS*	Ethylene Propylene

* For use with Tank Mount Nipples



When ordering Parker coupler bodies and nipples, please state the part number of each type of coupler body and each type of nipple desired. List coupler bodies and nipples as separate items rather than in combinations. Be sure to double check thread or hose sizes of items required.

Many of Parker's coupling products are available with unique non-standard options well suited to very specific applications. Examples of unusual end use applications might include: high temperatures (above 250° F), extremely caustic/corrosive solutions passing through the coupling, external/environmental corrosion situations, or other high wear and tear situations such as dragging the product along the ground. Please see the Fluid Compatibility Chart at the end of the catalog for a guide in selecting material for various media. It is always recommended that the Quick Coupling Division be contacted with any questions concerning specific product application needs.

Optional Seals Suffix*

No suffix is required when ordering products with the standard seals. When specifying an optional seal, refer to the following chart to determine the appropriate suffix.**

Coupling Series	Ethylene Propylene	Neoprene	Perfluoroelastomer
PF Series	E5	E12	E35*** E47****

* To select proper seal materials, see Fluid Compatibility Chart in Appendices section, or contact your Parker Quick Coupling Distributor.

**N/A = Not Available; STD = Standard (No Suffix Needed)

*** Parofluor™

**** DuPont Kalrez™



aerospace
 climate control
 electromechanical
 filtration
 fluid & gas handling
 hydraulics
 pneumatics
 process control
 sealing & shielding



Quick Coupling Products

Quick Couplings, Swivels, Valves,
 Diagnostic Equipment
 Catalog 3800 USA | February 2014



ENGINEERING YOUR SUCCESS.

Quick Coupling Division Locations



Minneapolis, MN



Grantsburg, WI



Chetek, WI



Union City, PA

WARNING

FAILURE OR IMPROPER SELECTION OR IMPROPER USE OF THE PRODUCTS DESCRIBED HEREIN OR RELATED ITEMS CAN CAUSE DEATH, PERSONAL INJURY AND PROPERTY DAMAGE.

- This document and other information from Parker-Hannifin Corporation, its subsidiaries and authorized distributors provide product or system options for further investigation by users having technical expertise.
- The user, through its own analysis and testing, is solely responsible for making the final selection of the system and components and assuring that all performance, endurance, maintenance, safety and warning requirements of the application are met. The user must analyze all aspects of the application, follow applicable industry standards, and follow the information concerning the product in the current product catalog and in any other materials provided from Parker or its subsidiaries or authorized distributors.
- To the extent that Parker or its subsidiaries or authorized distributors provide component or system options based upon data or specifications provided by the user, the user is responsible for determining that such data and specifications are suitable and sufficient for all applications and reasonably foreseeable uses of the components or systems.

Offer of Sale

The items described in this document are hereby offered for sale by Parker Hannifin Corporation, its subsidiaries or its authorized distributors. This offer and its acceptance are governed by the provisions stated in the "Offer of Sale."

Table of Contents

- Pneumatic Quick Couplings.....Section A**
- Hydraulic Quick Couplings.....Section B**
- Thermoplastic Couplings.....Section C**
- Swivels.....Section D**
- Valves.....Section E**
- Diagnostic Products.....Section F**

- Appendices:**
- Fluid Compatibility Chart.....I**
- Safety Guide.....VI**
- Offer of Sale.....IX**
- Glossary of Terms.....X**





Swivels

PS Series

Introduction	D-2
How To Order	D-4
In-Line	D-5
90°	D-16
Repair Kits	D-4
Seal Options	D-2

S Series

Introduction	D-34
How To Order	D-35
90°	D-36
Repair Kits	D-34



The PS Series Swivel is designed to meet today's application needs and performance requirements. Pressure capabilities up to 5000 psi, 1/4" through 2" body sizes, a variety of port options, Chromium-6 Free or nickel plating and a wide range of seal options make the PS Series Swivels ideal for an array of dynamic applications.

Features

- Hardened bearing races for extended service life.
- Full flow design minimizes pressure drop for optimum system performance.
- Sealed bearing design isolates bearing race from media and environment.
- Reduced bearing load design minimizes wear in the bearing race and extends service life.
- PTFE back-up rings support primary seal for high-pressure applications.
- Chromium-6 Free plating for maximum corrosion resistance.
- Variety of seal options available.
- Three piece swivel design for sizes 1 1/4" through 2" for superior performance and service life.
- Precision needle bearings and ball bearings sized 1 1/4" through 2" for additional side load resistance.
- Polyurethane U-Cup primary seal standard for sizes 1 1/4" through 2".
- PS Series Swivels eliminate hose twist and torque that may cause premature hose failure.

PS Series Specifications

Body Size (in.)	1/4	3/8	1/2	3/4	1	1 1/4	1 1/2	2
Maximum Rated Pressure (psi)	5000	5000	5000	5000	5000	4000	4000	3000
Except the following port options in the noted size								
03 (Male JIC 37°)							3000	2000
05 (Male SAE O-Ring Boss)								2500
06 (Female JIC 37°) 90° Housing Port				4000	3000	3000	2500	2000
06 (Female JIC 37°) In-Line Housing Port							3000	2000
07 (Female NPSM)			4600	3000	2600	2100	1650	1500
Temperature Range (std seals)	-40° to 250° F					-30° to 180° F		

Seal Options

Nitrile (standard unless otherwise designated)
A = Aflas™
W = Ethylene Propylene
Y = Fluorocarbon
Z = Neoprene
For Perfluoroelastomer seal option contact the division.

Performance Data

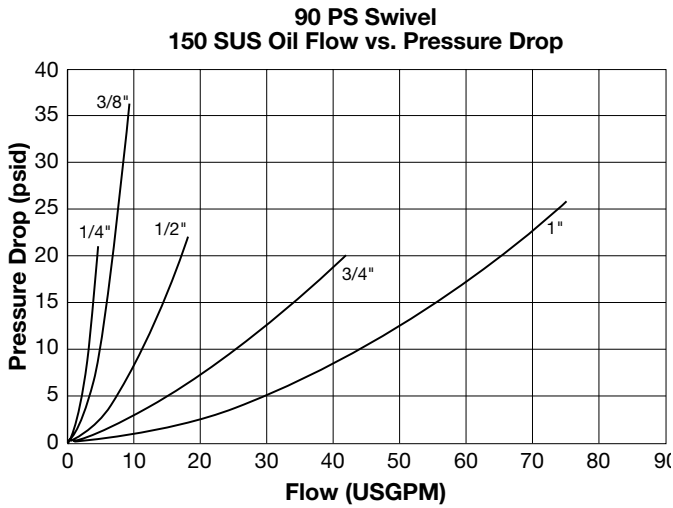
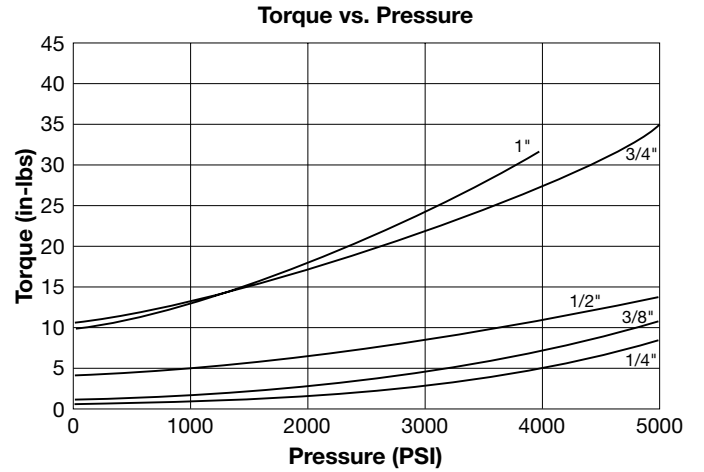
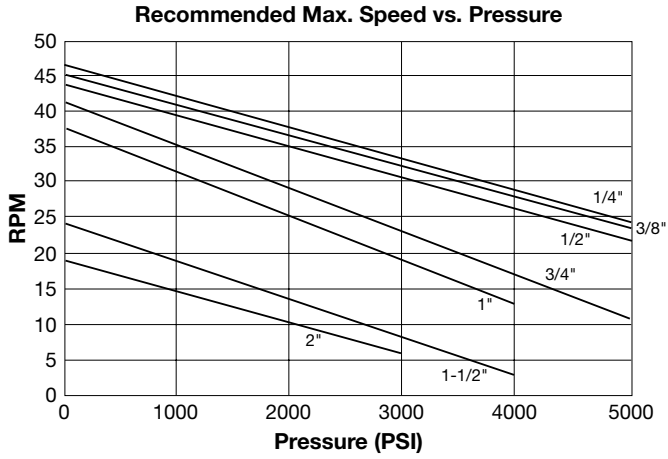

In-Line Swivels

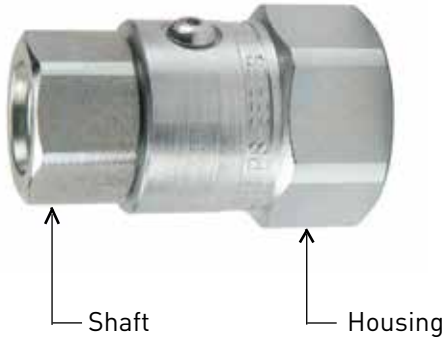

90° Swivels



PS Part Number:

PS 16 1 02 02-16-16 Y-

Material and Finish:

- Blank = Carbon Steel w/Chromium-6 Free Plating (Std.)
- NI = Carbon Steel with Electroless Nickel Plating*
- S3 = 303 Stainless Steel Passivated*
- S6 = 316 Stainless Steel Electropolished*

Seal Code:

- Blank = Nitrile†
- A = Aflas™*
- W = Ethylene Propylene
- Y = Fluorocarbon
- Z = Neoprene
- For Perfluoroelastomer Seal Option Contact the Division.

Housing Port Size (1/16 of an inch)††

Shaft Port Size (1/16 of an inch)††

Housing Port Configuration:

- 01 = Male NPTF(Non-Standard)*
- 02 = Female NPTF
- 03 = Male JIC 37 Degree
- 05 = Male SAE O-Ring Straight Thread
- 06 = Female JIC 37 Degree
- 07 = Female NPSM Pipe Swivel
- 10 = Female SAE Straight Thread
- JM = Male Seal-Lok

Shaft Port Configuration:

- 01 = Male NPTF
- 02 = Female NPTF
- 03 = Male JIC 37 Degree
- 05 = Male SAE O-Ring Straight Thread
- 10 = Female SAE Straight Thread
- JM = Male Seal-Lok

Configuration:

- 1 = In-line
- 9 = 90 degree

Body Size (1/16 of an inch)

Parker Swivel designator

*Contact Division for price and delivery

† On -24 and -32 sizes, Polyurethane U-Cup Seal is standard.

†† For -20 Ports, -24 Body is used.

PS Series Repair Kits (In-line and 90°)

Repair Kits come complete with O-Rings, PTFE Back-Up Ring, Cap Screws, Locking Balls, Retaining Ring and grease fitting. Repair kits are suitable for both current and previous design in-line and 90° PS Series Swivels.

1/4" Swivel	3/8" Swivel	1/2" Swivel	3/4" Swivel	1" Swivel
PS4-RPR	PS6-RPR	PS8-RPR	PS12-RPR	PS16-RPR
PS4Y-RPR	PS6Y-RPR	PS8Y-RPR	PS12Y-RPR	PS16Y-RPR
PS4A-RPR	PS6A-RPR	PS8A-RPR	PS12A-RPR	PS16A-RPR
PS4W-RPR	PS6W-RPR	PS8W-RPR	PS12W-RPR	PS16W-RPR

H2C-PS = Bearing Removal Pneumatic Nipple



Materials Of Construction

Housing*: Carbon Steel
 Shaft*: Carbon Steel
 Plating*: Chromium-6 Free
 Bearing*: Chrome
 O-Rings*: Nitrile
 Back-Up Ring PTFE

* See How-To-Order for optional material, plating, and seals.

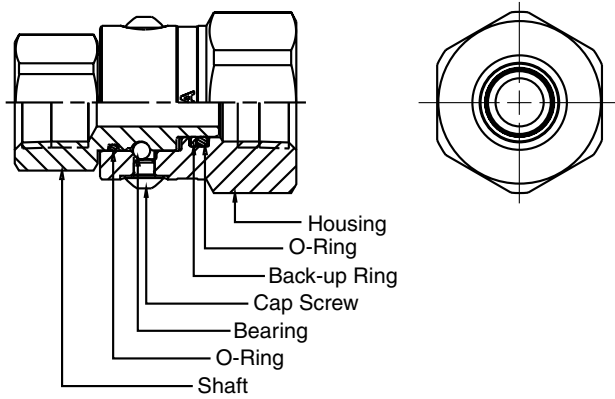

Male Pipe - Female Pipe

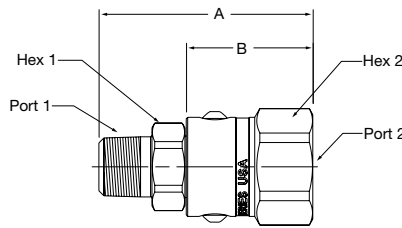

Part Number	A	B	Port 1	Port 2	Wrench Flats 1	Wrench Flats 2
PS410102-4-4	2.59" 65.8 mm	1.60" 40.6 mm	1/4-18 NPTF	1/4-18 NPTF	.75" 19.0 mm	1.19" 30.2 mm
PS610102-6-6	2.66" 67.5 mm	1.64" 41.7 mm	3/8-18 NPTF	3/8-18 NPTF	.88" 22.2 mm	1.31" 33.3 mm
PS810102-8-8	3.03" 76.8 mm	1.79" 45.5 mm	1/2-14 NPTF	1/2-14 NPTF	1.12" 28.6 mm	1.50" 36.5 mm
PS1210102-12-12	3.10" 78.8 mm	1.85" 47.0 mm	3/4-14 NPTF	3/4-14 NPTF	1.38" 35.0 mm	1.69" 42.9 mm
PS1610102-16-16	3.54" 89.8 mm	2.11" 53.5 mm	1-11 1/2 NPTF	1-11 1/2 NPTF	1.62" 41.3 mm	1.88" 47.6 mm

Male Pipe - Male 37° Flair

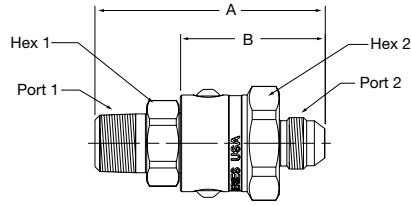

Part Number	A	B	Port 1	Port 2	Wrench Flats 1	Wrench Flats 2
PS410103-4-4	2.86" 72.6 mm	1.87" 47.5 mm	1/4-18 NPTF	7/16-20 UNF	.75" 19.0 mm	1.19" 30.2 mm
PS610103-6-6	2.92" 74.1 mm	1.90" 48.3 mm	3/8-18 NPTF	9/16-18 UNF	.88" 22.2 mm	1.31" 33.3 mm
PS810103-8-8	3.33" 84.5 mm	2.09" 53.1 mm	1/2-14 NPTF	3/4-16 UNF	1.12" 28.6 mm	1.50" 36.5 mm
PS1210103-12-12	3.55" 90.3 mm	2.30" 58.4 mm	3/4-14 NPTF	1-1/16-12 UN	1.38" 35.0 mm	1.69" 42.9 mm
PS1610103-16-16	3.88" 98.6 mm	2.45" 62.2 mm	1-11 1/2 NPTF	1-5/16-12 UN	1.62" 41.3 mm	1.88" 47.6 mm

Male Pipe - Female 37° Flair

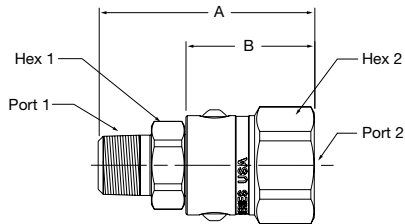

Part Number	A	B	Port 1	Port 2	Wrench Flats 1	Wrench Flats 2
PS410106-4-4	2.72" 69.1 mm	1.73" 43.9 mm	1/4-18 NPTF	7/16-20 UNF	.75" 19.0 mm	1.19" 30.2 mm
PS610106-6-6	2.77" 70.3 mm	1.75" 44.5 mm	3/8-18 NPTF	9/16-18 UNF	.88" 22.2 mm	1.31" 33.3 mm
PS810106-8-8	3.05" 77.3 mm	1.81" 46.0 mm	1/2-14 NPTF	3/4-16 UNF	1.12" 28.6 mm	1.50" 36.5 mm
PS1210106-12-12	3.27" 83.2 mm	2.02" 51.3 mm	3/4-14 NPTF	1-1/16-12 UN	1.38" 35.0 mm	1.69" 42.9 mm
PS1610106-16-16	3.62" 92.0 mm	2.19" 55.6 mm	1-11 1/2 NPTF	1-5/16-12 UN	1.62" 41.3 mm	1.88" 47.6 mm

D Swivels

Male Pipe - Female SAE Straight Thread

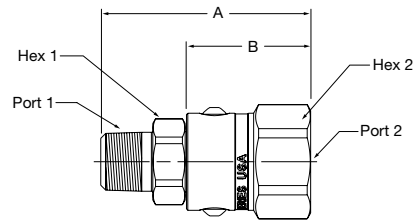

Part Number	A	B	Port 1	Port 2	Wrench Flats 1	Wrench Flats 2
PS410110-4-4	2.71" 68.8 mm	1.72" 43.7 mm	1/4-18 NPTF	7/16-20 UNF	.75" 19.0 mm	1.19" 30.2 mm
PS610110-6-6	2.74" 69.6 mm	1.72" 43.7 mm	3/8-18 NPTF	9/16-18 UNF	.88" 22.2 mm	1.31" 33.3 mm
PS810110-8-8	3.03" 76.8 mm	1.79" 45.5 mm	1/2-14 NPTF	3/4-16 UNF	1.12" 28.6 mm	1.50" 36.5 mm
PS1210110-12-12	3.33" 84.7 mm	2.08" 52.8 mm	3/4-14 NPTF	1-1/16-12 UN	1.38" 35.0 mm	1.69" 42.9 mm
PS1610110-16-16	3.63" 92.2 mm	2.20" 55.9 mm	1-11/2 NPTF	1-5/16-20 UN	1.62" 41.3 mm	1.88" 47.6 mm

Female Pipe - Female Pipe

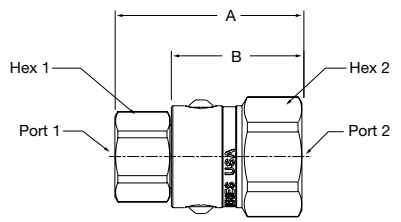

Part Number	A	B	Port 1	Port 2	Wrench Flats 1	Wrench Flats 2
PS410202-4-4	2.16" 54.9 mm	1.60" 40.6 mm	1/4-18 NPTF	1/4-18 NPTF	.75" 19.0 mm	1.19" 30.2 mm
PS610202-6-6	2.30" 58.3 mm	1.64" 41.7 mm	3/8-18 NPTF	3/8-18 NPTF	.88" 22.2 mm	1.31" 33.3 mm
PS810202-8-8	2.56" 65.0 mm	1.79" 45.5 mm	1/2-14 NPTF	1/2-14 NPTF	1.12" 28.6 mm	1.50" 36.5 mm
PS1210202-12-12	2.88" 73.1 mm	1.85" 47.0 mm	3/4-14 NPTF	3/4-14 NPTF	1.38" 35.0 mm	1.69" 42.9 mm
PS1610202-16-16	3.16" 80.1 mm	2.11" 53.5 mm	1-11/2 NPTF	1-11/2 NPTF	1.62" 41.3 mm	1.88" 47.6 mm

3 Piece Design

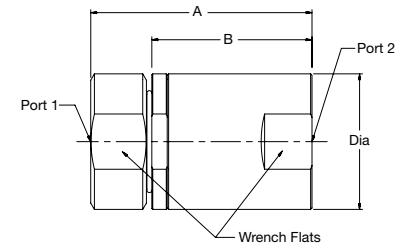

Part Number	A	B	Wrench Flats 1	Wrench Flats 2	Port 1	Port 2
PS2410202-20-20	4.67" 118.6 mm	3.38" 85.9 mm	2.63" 66.7 mm	2.88" 73.0 mm	1 1/4-11 1/2 NPTF	1 1/4-11 1/2 NPTF
PS2410202-24-24	4.67" 118.6 mm	3.38" 85.9 mm	2.63" 66.7 mm	2.88" 73.0 mm	1 1/2-11 1/2 NPTF	1 1/2-11 1/2 NPTF
PS3210202-32-32	4.88" 123.9 mm	3.58" 90.8 mm	3.06" 77.6 mm	3.35" 85.1 mm	2-11 1/2 NPTF	2-11 1/2 NPTF



Female Pipe - Male 37° Flare

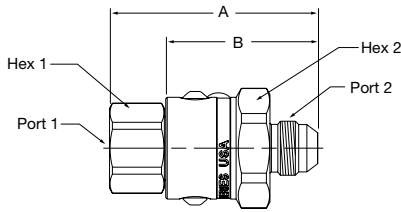

Part Number	A	B	Port 1	Port 2	Wrench Flats 1	Wrench Flats 2
PS410203-4-4	2.43" 61.7 mm	1.87" 47.5 mm	1/4-18 NPTF	7/16-20 UNF	.75" 19.0 mm	1.19" 30.2 mm
PS610203-6-6	2.56" 65.0 mm	1.90" 48.3 mm	3/8-18 NPTF	9/16-18 UNF	.88" 22.2 mm	1.31" 33.3 mm
PS810203-8-8	2.86" 72.7 mm	2.09" 53.1 mm	1/2-14 NPTF	3/4-16 UNF	1.12" 28.6 mm	1.50" 36.5 mm
PS1210203-12-12	3.33" 84.5 mm	2.30" 58.4 mm	3/4-14 NPTF	1-1/16-12 UN	1.38" 35.0 mm	1.69" 42.9 mm
PS1610203-16-16	3.50" 88.9 mm	2.45" 62.2 mm	1-11 1/2 NPTF	1-5/16-12 UN	1.62" 41.3 mm	1.88" 47.6 mm

3 Piece Design

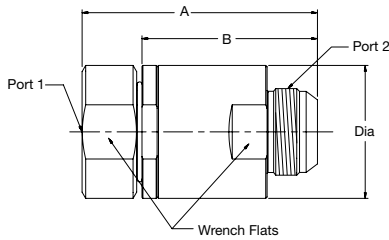

Part Number	A	B	Port 1	Port 2	Wrench Flats 1	Wrench Flats 2
PS2410203-20-20	5.06" 128.6 mm	3.78" 95.9 mm	1 1/4-11 1/2 NPTF	1 5/8-12 UN	2.63" 66.7 mm	2.88" 73.0 mm
PS2410203-24-24	5.06" 128.6 mm	3.78" 95.9 mm	1 1/2-11 1/2 NPTF	1 7/8-12 UN	2.63" 66.7 mm	2.88" 73.0 mm
PS3210203-32-32	5.58" 141.7 mm	4.28" 108.6 mm	2-11 1/2 NPTF	2 1/2-12 UN	3.06" 77.6 mm	3.35" 85.1 mm

Female Pipe - Female 37° Flare

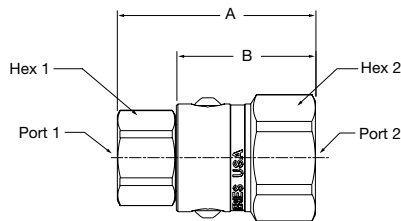

Part Number	A	B	Port 1	Port 2	Wrench Flats 1	Wrench Flats 2
PS410206-4-4	2.29" 58.2 mm	1.73" 43.9 mm	1/4-18 NPTF	7/16-20 UNF	.75" 19.0 mm	1.19" 30.2 mm
PS610206-6-6	2.41" 61.1 mm	1.75" 44.5 mm	3/8-18 NPTF	9/16-18 UNF	.88" 22.2 mm	1.31" 33.3 mm
PS810206-8-8	2.58" 65.6 mm	1.81" 46.0 mm	1/2-14 NPTF	3/4-16 UNF	1.12" 28.6 mm	1.50" 36.5 mm
PS1210206-12-12	3.05" 77.4 mm	2.02" 51.3 mm	3/4-14 NPTF	1-1/16-12 UN	1.38" 35.0 mm	1.69" 42.9 mm
PS1610206-16-16	3.24" 82.3 mm	2.19" 55.6 mm	1-11 1/2 NPTF	1-5/16-12 UN	1.62" 41.3 mm	1.88" 47.6 mm

Female Pipe - Female SAE Straight Thread

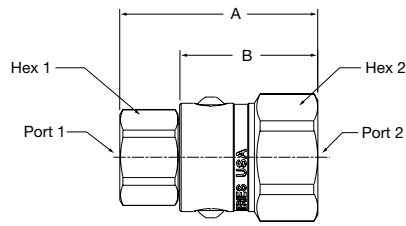

Part Number	A	B	Port 1	Port 2	Wrench Flats 1	Wrench Flats 2
PS410210-4-4	2.28" 57.9 mm	1.72" 43.7 mm	1/4-18 NPTF	7/16-20 UNF	.75" 19.0 mm	1.19" 30.2 mm
PS610210-6-6	2.38" 60.4 mm	1.72" 43.7 mm	3/8-18 NPTF	9/16-18 UNF	.88" 22.2 mm	1.31" 33.3 mm
PS810210-8-8	2.56" 65.0 mm	1.79" 45.5 mm	1/2-14 NPTF	3/4-16 UNF	1.12" 28.6 mm	1.50" 36.5 mm
PS1210210-12-12	3.11" 78.9 mm	2.08" 52.8 mm	3/4-14 NPTF	1-1/16-12 UN	1.38" 35.0 mm	1.69" 42.9 mm
PS1610210-16-16	3.25" 82.6 mm	2.20" 55.9 mm	1-11 1/2 NPTF	1-5/16-20 UN	1.62" 41.3 mm	1.88" 47.6 mm

Male 37° Flare - Female Pipe

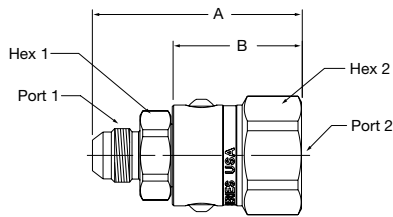

Part Number	A	B	Port 1	Port 2	Wrench Flats 1	Wrench Flats 2
PS410302-4-4	2.59" 65.8 mm	1.60" 40.6 mm	7/16-20 UNF	1/4-18 NPTF	.75" 19.0 mm	1.19" 30.2 mm
PS610302-6-6	2.66" 67.5 mm	1.64" 41.7 mm	9/16-18 UNF	3/8-18 NPTF	.88" 22.2 mm	1.31" 33.3 mm
PS810302-8-8	2.89" 73.5 mm	1.79" 45.5 mm	3/4-16 UNF	1/2-14 NPTF	1.12" 28.6 mm	1.50" 36.5 mm
PS1210302-12-12	3.21" 81.5 mm	1.85" 47.0 mm	1-1/16-12 UN	3/4-14 NPTF	1.38" 35.0 mm	1.69" 42.9 mm
PS1610302-16-16	3.54" 89.8 mm	2.11" 53.5 mm	1-5/16-12 UN	1-11 1/2 NPTF	1.62" 41.3 mm	1.88" 47.6 mm

3 Piece Design

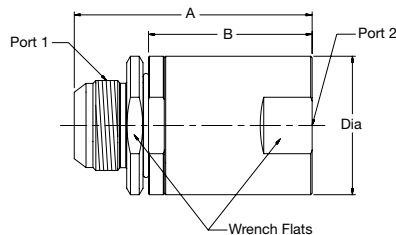

Part Number	A	B	Port 1	Port 2	Wrench Flats 1	Wrench Flats 2
PS2410302-20-20	4.91" 124.8 mm	3.38" 85.9 mm	1 5/8-12 UN	1 1/4-11 1/2 NPTF	2.63" 66.7 mm	2.88" 73.0 mm
PS2410302-24-24	4.91" 124.8 mm	3.38" 85.9 mm	1 7/8-12 UN	1 1/2-11 1/2 NPTF	2.63" 66.7 mm	2.88" 73.0 mm
PS3210302-32-32	5.50" 139.8 mm	3.58" 90.8 mm	2 1/2-12 UN	2-11 1/2 NPTF	3.06" 77.6 mm	3.35" 85.1 mm

Male 37° Flare - Male 37° Flare

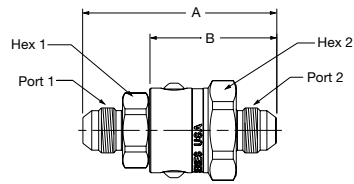

Part Number	A	B	Port 1	Port 2	Wrench Flats 1	Wrench Flats 2
PS410303-4-4	2.86" 72.6 mm	1.87" 47.5 mm	7/16-20 UNF	7/16-20 UNF	.75" 19.0 mm	1.19" 30.2 mm
PS610303-6-6	2.92" 74.1 mm	1.90" 48.3 mm	9/16-18 UNF	9/16-18 UNF	.88" 22.2 mm	1.31" 33.3 mm
PS810303-8-8	3.19" 81.1 mm	2.09" 53.1 mm	3/4-16 UNF	3/4-16 UNF	1.12" 28.6 mm	1.50" 36.5 mm
PS810303-10-10	3.39" 86.2 mm	2.19" 55.6 mm	7/8-14 UNF	7/8-14 UNF	1.12" 28.6 mm	1.50" 36.5 mm
PS1210303-12-12	3.66" 92.9 mm	2.30" 58.4 mm	1-1/16-12 UN	1-1/16-12 UN	1.38" 35.0 mm	1.69" 42.9 mm
PS1610303-16-16	3.88" 98.6 mm	2.45" 62.2 mm	1-5/16-12 UN	1-5/16-12 UN	1.62" 41.3 mm	1.88" 47.6 mm

3 Piece Design

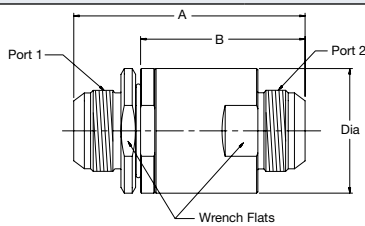

Part Number	A	B	Port 1	Port 2	Wrench Flats 1	Wrench Flats 2
PS2410303-20-20	5.31" 134.8 mm	3.78" 95.9 mm	1 5/8-12 UN	1 5/8-12 UN	2.63" 66.7 mm	2.88" 73.0 mm
PS2410303-24-24	5.31" 134.8 mm	3.78" 95.9 mm	1 7/8-12 UN	1 7/8-12 UN	2.63" 66.7 mm	2.88" 73.0 mm
PS3210303-32-32	6.20" 157.5 mm	4.28" 108.6 mm	2 1/2-12 UN	2 1/2-12 UN	3.06" 77.6 mm	3.35" 85.1 mm

Male 37° Flare - Female 37° Flare

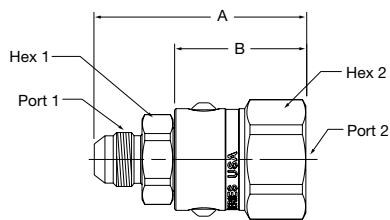

Part Number	A	B	Port 1	Port 2	Wrench Flats 1	Wrench Flats 2
PS410306-4-4	2.72" 69.1 mm	1.73" 43.9 mm	7/16-20 UNF	7/16-20 UNF	.75" 19.0 mm	1.19" 30.2 mm
PS610306-6-6	2.77" 70.3 mm	1.75" 44.5 mm	9/16-18 UNF	9/16-18 UNF	.88" 22.2 mm	1.31" 33.3 mm
PS810306-8-8	2.91" 74.0 mm	1.81" 46.0 mm	3/4-16 UNF	3/4-16 UNF	1.12" 28.6 mm	1.50" 36.5 mm
PS1210306-12-12	3.38" 85.8 mm	2.02" 51.3 mm	1-1/16-12 UN	1-1/16-12 UN	1.38" 35.0 mm	1.69" 42.9 mm
PS1610306-16-16	3.62" 92.0 mm	2.19" 55.6 mm	1-5/16-12 UN	1-5/16-12 UN	1.62" 41.3 mm	1.88" 47.6 mm

Male 37° Flare - Female SAE Straight Thread

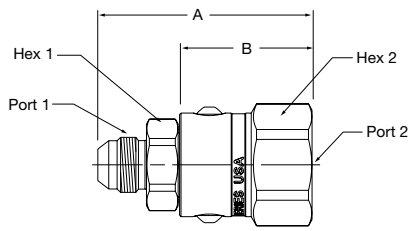

Part Number	A	B	Port 1	Port 2	Wrench Flats 1	Wrench Flats 2
PS410310-4-4	2.71" 68.8 mm	1.72" 43.7 mm	7/16-20 UNF	7/16-20 UNF	.75" 19.0 mm	1.19" 30.2 mm
PS610310-6-6	2.74" 69.6 mm	1.72" 43.7 mm	9/16-18 UNF	9/16-18 UNF	.88" 22.2 mm	1.31" 33.3 mm
PS810310-8-8	2.89" 73.5 mm	1.79" 45.5 mm	3/4-16 UNF	3/4-16 UNF	1.12" 28.6 mm	1.50" 36.5 mm
PS1210310-12-12	3.44" 87.3 mm	2.08" 52.8 mm	1-1/16-12 UN	1-1/16-12 UN	1.38" 35.0 mm	1.69" 42.9 mm
PS1610310-16-16	3.63" 92.2 mm	2.20" 55.9 mm	1-5/16-12 UN	1-5/16-12 UN	1.62" 41.3 mm	1.88" 47.6 mm

3 Piece Design

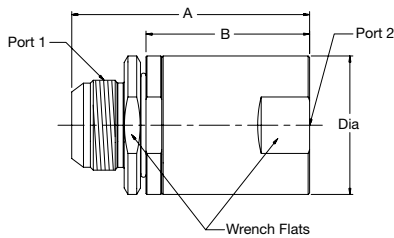

Part Number	A	B	C	D	Diameter	Port 1	Port 2	Wrench Flats
PS2410310-20-20	6.16" 150.2 mm	4.63" 117.5 mm	3.43" 87.0 mm	1.27" 32.3 mm	2.63" 66.7 mm	1 5/8-12 UN	1 5/8-12 UN	3.36" 85.2 mm
PS2410310-24-24	6.16" 150.2 mm	4.63" 117.5 mm	3.43" 87.0 mm	1.27" 32.3 mm	2.63" 66.7 mm	17/8-12 UN	17/8-12 UN	3.36" 85.2 mm
PS3210310-32-32	7.38" 187.4 mm	5.45" 138.4 mm	3.93" 99.7 mm	1.52" 38.5 mm	3.06" 77.6 mm	2 1/2-12 UN	2 1/2-12 UN	4.19" 106.4 mm

Male SAE O-Ring Straight Thread - Female Pipe

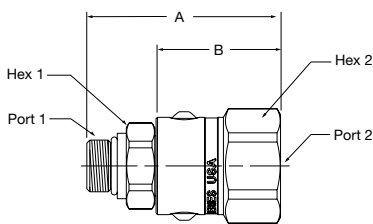

Part Number	A	B	Port 1	Port 2	Wrench Flats 1	Wrench Flats 2
PS410502-4-4	2.44" 62.1 mm	1.60" 40.6 mm	7/16-20 UNF	1/4-18 NPTF	.75" 19.0 mm	1.19" 30.2 mm
PS610502-6-6	2.48" 63.0 mm	1.64" 41.7 mm	9/16-18 UNF	3/8-18 NPTF	.88" 22.2 mm	1.31" 33.3 mm
PS810502-8-8	2.79" 70.8 mm	1.79" 45.5 mm	3/4-16 UNF	1/2-14 NPTF	1.12" 28.6 mm	1.50" 36.5 mm
PS1210502-12-12	3.02" 76.7 mm	1.85" 47.0 mm	1-1/16-12 UN	3/4-14 NPTF	1.38" 35.0 mm	1.69" 42.9 mm
PS1610502-16-16	3.31" 84.1 mm	2.11" 53.5 mm	1-5/16-12 UN	1-11 1/2 NPTF	1.62" 41.3 mm	1.88" 47.6 mm

Male SAE O-Ring Straight Thread - Male 37° Flare

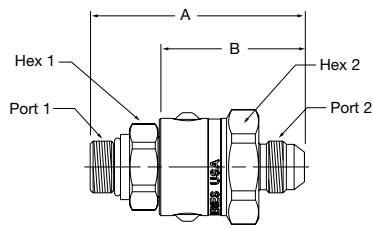

Part Number	A	B	Port 1	Port 2	Wrench Flats 1	Wrench Flats 2
PS410503-4-4	2.71" 68.9 mm	1.87" 47.5 mm	7/16-20 UNF	7/16-20 UNF	.75" 19.0 mm	1.19" 30.2 mm
PS610503-6-6	2.74" 69.6 mm	1.90" 48.3 mm	9/16-18 UNF	9/16-18 UNF	.88" 22.2 mm	1.31" 33.3 mm
PS810503-8-8	3.09" 78.4 mm	2.09" 53.1 mm	3/4-16 UNF	3/4-16 UNF	1.12" 28.6 mm	1.50" 36.5 mm
PS810503-10-10	3.25" 82.5 mm	2.19" 55.6 mm	7/8-14 UNF	7/8-14 UNF	1.12" 28.6 mm	1.50" 36.5 mm
PS1210503-12-12	3.47" 88.2 mm	2.30" 58.4 mm	1-1/16-12 UN	1-1/16-12 UN	1.38" 35.0 mm	1.69" 42.9 mm
PS1610503-16-16	3.66" 92.9 mm	2.45" 62.2 mm	1-5/16-12 UN	1-5/16-12 UN	1.62" 41.3 mm	1.88" 47.6 mm

Male SAE O-Ring Straight Thread - Female 37° Flare

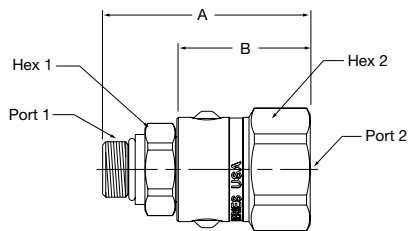

Part Number	A	B	Port 1	Port 2	Wrench Flats 1	Wrench Flats 2
PS410506-4-4	2.57" 65.4 mm	1.73" 43.9 mm	7/16-20 UNF	7/16-20 UNF	.75" 19.0 mm	1.19" 30.2 mm
PS610506-6-6	2.59" 65.8 mm	1.75" 44.5 mm	9/16-18 UNF	9/16-18 UNF	.88" 22.2 mm	1.31" 33.3 mm
PS810506-8-8	2.81" 71.3 mm	1.81" 46.0 mm	3/4-16 UNF	3/4-16 UNF	1.12" 28.6 mm	1.50" 36.5 mm
PS1210506-12-12	3.19" 81.1 mm	2.02" 51.3 mm	1-1/16-12 UN	1-1/16-12 UN	1.38" 35.0 mm	1.69" 42.9 mm
PS1610506-16-16	3.40" 86.3 mm	2.19" 55.6 mm	1-5/16-12 UN	1-5/16-12 UN	1.62" 41.3 mm	1.88" 47.6 mm

Male SAE O-Ring Straight Thread - Female SAE Straight Thread

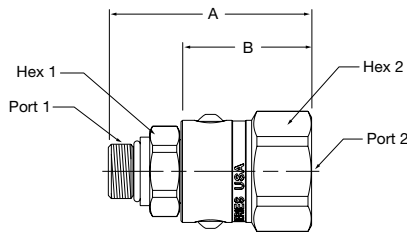

Part Number	A	B	Port 1	Port 2	Wrench Flats 1	Wrench Flats 2
PS410510-4-4	2.56" 65.0 mm	1.72" 43.7 mm	7/16-20 UNF	7/16-20 UNF	.75" 19.0 mm	1.19" 30.2 mm
PS610510-6-6	2.56" 65.0 mm	1.72" 43.7 mm	9/16-18 UNF	9/16-18 UNF	.88" 22.2 mm	1.31" 33.3 mm
PS810510-8-8	2.79" 70.8 mm	1.79" 45.5 mm	3/4-16 UNF	3/4-16 UNF	1.12" 28.6 mm	1.50" 36.5 mm
PS1210510-12-12	3.25" 82.6 mm	2.08" 52.8 mm	1-1/16-12 UN	1-1/16-12 UN	1.38" 35.0 mm	1.69" 42.9 mm
PS1610510-16-16	3.41" 86.5 mm	2.20" 55.9 mm	1-5/16-12 UN	1-5/16-12 UN	1.62" 41.3 mm	1.88" 47.6 mm

Female SAE Straight Thread - Female Pipe

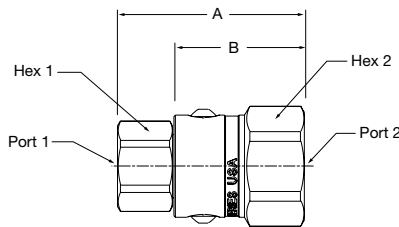

Part Number	A	B	Port 1	Port 2	Wrench Flats 1	Wrench Flats 2
PS411002-4-4	2.16" 55.0 mm	1.60" 40.6 mm	7/16-20 UNF	1/4-18 NPTF	.75" 19.0 mm	1.19" 30.2 mm
PS611002-6-6	2.30" 58.3 mm	1.64" 41.7 mm	9/16-18 UNF	3/8-18 NPTF	.88" 22.2 mm	1.31" 33.3 mm
PS811002-8-8	2.56" 65.0 mm	1.79" 45.5 mm	3/4-16 UNF	1/2-14 NPTF	1.12" 28.6 mm	1.50" 36.5 mm
PS1211002-12-12	2.88" 73.1 mm	1.85" 47.0 mm	1-1/16-12 UN	3/4-14 NPTF	1.38" 35.0 mm	1.69" 42.9 mm
PS1611002-16-16	3.16" 80.1 mm	2.11" 53.5 mm	1-5/16-12 UN	1-11 1/2 NPTF	1.62" 41.3 mm	1.88" 47.6 mm

Female SAE Straight Thread - Male 37° Flare

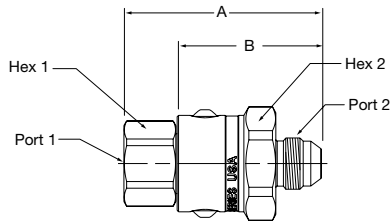

Part Number	A	B	Port 1	Port 2	Wrench Flats 1	Wrench Flats 2
PS411003-4-4	2.43" 61.8 mm	1.87" 47.5 mm	7/16-20 UNF	7/16-20 UNF	.75" 19.0 mm	1.19" 30.2 mm
PS611003-6-6	2.56" 65.0 mm	1.90" 48.3 mm	9/16-18 UNF	9/16-18 UNF	.88" 22.2 mm	1.31" 33.3 mm
PS811003-8-8	2.86" 72.7 mm	2.09" 53.1 mm	3/4-16 UNF	3/4-16 UNF	1.12" 28.6 mm	1.50" 36.5 mm
PS1211003-12-12	3.33" 84.5 mm	2.30" 58.4 mm	1-1/16-12 UN	1-1/16-12 UN	1.38" 35.0 mm	1.69" 42.9 mm
PS1611003-16-16	3.50" 88.9 mm	2.45" 62.2 mm	1-5/16-12 UN	1-5/16-12 UN	1.62" 41.3 mm	1.88" 47.6 mm

Female SAE Straight Thread - Female 37° Flare

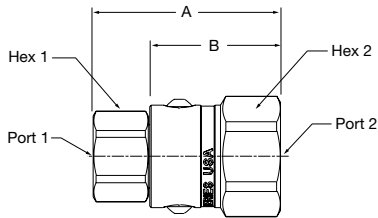

Part Number	A	B	Port 1	Port 2	Wrench Flats 1	Wrench Flats 2
PS411006-4-4	2.29" 58.3 mm	1.73" 43.9 mm	7/16-20 UNF	7/16-20 UNF	.75" 19.0 mm	1.19" 30.2 mm
PS611006-6-6	2.41" 61.1 mm	1.75" 44.5 mm	9/16-18 UNF	9/16-18 UNF	.88" 22.2 mm	1.31" 33.3 mm
PS811006-8-8	2.58" 65.6 mm	1.81" 46.0 mm	3/4-16 UNF	3/4-16 UNF	1.12" 28.6 mm	1.50" 36.5 mm
PS1211006-12-12	3.05" 77.4 mm	2.02" 51.3 mm	1-1/16-12 UN	1-1/16-12 UN	1.38" 35.0 mm	1.69" 42.9 mm
PS1611006-16-16	3.24" 82.3 mm	2.19" 55.6 mm	1-5/16-12 UN	1-5/16-12 UN	1.62" 41.3 mm	1.88" 47.6 mm

Female SAE Straight Thread - Female SAE Straight Thread

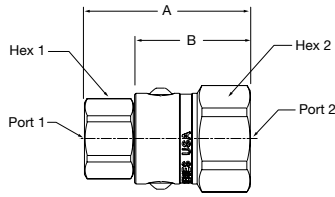

Part Number	A	B	Port 1	Port 2	Wrench Flats 1	Wrench Flats 2
PS411010-4-4	2.28" 58.0 mm	1.72" 43.7 mm	7/16-20 UNF	7/16-20 UNF	.75" 19.0 mm	1.19" 30.2 mm
PS611010-6-6	2.38" 60.4 mm	1.72" 43.7 mm	9/16-18 UNF	9/16-18 UNF	.88" 22.2 mm	1.31" 33.3 mm
PS811010-8-8	2.56" 65.0 mm	1.79" 45.5 mm	3/4-16 UNF	3/4-16 UNF	1.12" 28.6 mm	1.50" 36.5 mm
PS1211010-12-12	3.11" 78.9 mm	2.08" 52.8 mm	1-1/16-12 UN	1-1/16-12 UN	1.38" 35.0 mm	1.69" 42.9 mm
PS1611010-16-16	3.25" 82.6 mm	2.20" 55.9 mm	1-5/16-12 UN	1-5/16-12 UN	1.62" 41.3 mm	1.88" 47.6 mm

3 Piece Design

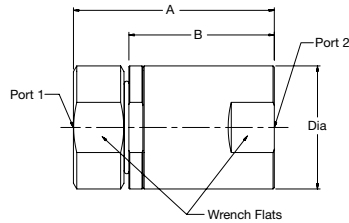

Part Number	A	B	C	D	Diameter	Port 1	Port 2	Wrench Flats
PS2411010-20-20	5.91" 150.2 mm	4.63" 117.5 mm	3.43" 87.0 mm	1.27" 32.3 mm	2.63" 66.7 mm	1 5/8-12 UN	1 5/8-12 UN	3.36" 85.2 mm
PS2411010-24-24	5.91" 150.2 mm	4.63" 117.5 mm	3.43" 87.0 mm	1.27" 32.3 mm	2.63" 66.7 mm	1 7/8-12 UN	1 7/8-12 UN	3.36" 85.2 mm
PS3211010-32-32	6.83" 173.6 mm	5.45" 138.4 mm	3.93" 99.7 mm	1.52" 38.5 mm	3.06" 77.6 mm	2 1/2-12 UN	2-1/2-12 UN	4.19" 106.4 mm

Male Seal-Lok - Male Seal-Lok

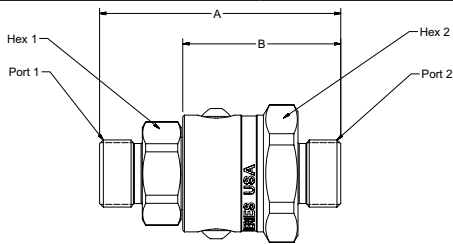

Part Number	A	B	Port 1	Port 2	Wrench Flats 1	Wrench Flats 2
PS61JMJM-6-6	2.67" 67.8 mm	1.83" 46.5 mm	11/16 - 16 UN	11/16 - 16 UN	.88" 22.2 mm	1.31" 33.3 mm
PS81JMJM-8-8	2.89" 73.4 mm	1.90" 48.3 mm	13/16 - 16 UN	13/16 - 16 UN	1.12" 28.6 mm	1.50" 38.1 mm
PS121JMJM-12-12	3.26" 82.8 mm	2.09" 53.1 mm	1-3/16 - 12 UN	1-3/16 - 12 UN	1.38" 35.0 mm	1.75" 44.4 mm
PS161JMJM-16-16	3.41" 86.6 mm	2.20" 55.9 mm	1-7/16 - 12 UN	1-7/16 - 12 UN	1.62" 41.3 mm	1.88" 47.8 mm



Materials Of Construction

Housing*: Carbon Steel
 Shaft*: Carbon Steel
 Plating:* Chromium-6 Free
 Bearing:* Chrome
 O-Rings:* Nitrile
 Back-Up Ring PTFE

* See How-To-Order for optional material, plating, and seals.

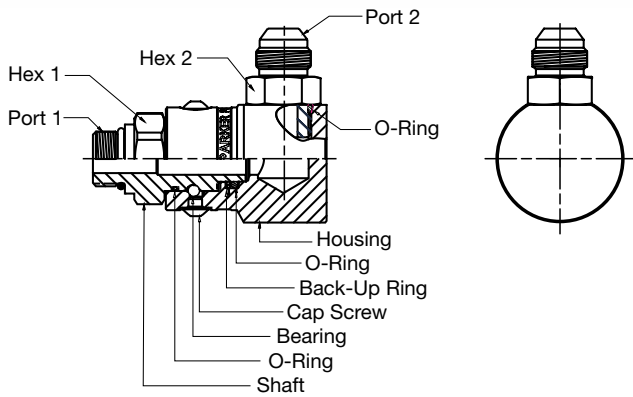

Male Pipe - Female Pipe

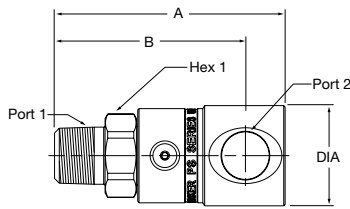

Part Number	A	B	Diameter	Port 1	Port 2	Wrench Flats 1
PS490102-4-4	2.85" 72.3 mm	2.44" 62.0 mm	1.20" 30.5 mm	1/4-18 NPTF	1/4-18 NPTF	.75" 19.0 mm
PS690102-6-6	3.05" 77.4 mm	2.54" 64.4 mm	1.29" 32.8 mm	3/8-18 NPTF	3/8-18 NPTF	.88" 22.2 mm
PS890102-8-8	3.43" 87.0 mm	2.84" 72.0 mm	1.49" 37.8 mm	1/2-14 NPTF	1/2-14 NPTF	1.12" 28.6 mm
PS1290102-12-12	3.66" 93.0 mm	3.00" 76.1 mm	1.76" 44.6 mm	3/4-14 NPTF	3/4-14 NPTF	1.38" 35.0 mm
PS1690102-16-16	4.41" 112.0 mm	3.54" 90.0 mm	2.16" 54.9 mm	1-11 1/2 NPTF	1-11 1/2 NPTF	1.62" 41.3 mm

D Swivels

Male Pipe - Male 37° Flare

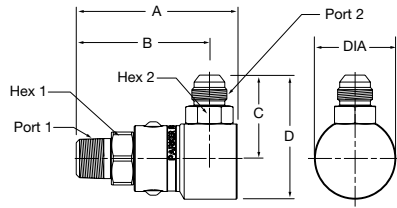

Part Number	A	B	C	D	Diameter	Port 1	Port 2	Wrench Flats 1	Wrench Flats 2
PS490103-4-4	2.85" 72.3 mm	2.44" 62.0 mm	1.39" 35.2 mm	1.99" 50.5 mm	1.20" 30.5 mm	1/4-18 NPTF	7/16-20 UNF	.75" 19.0 mm	.56" 14.3 mm
PS690103-6-6	3.05" 77.4 mm	2.54" 64.4 mm	1.44" 36.6 mm	2.09" 53.0 mm	1.29" 32.8 mm	3/8-18 NPTF	9/16-18 UNF	.88" 22.2 mm	.69" 17.5 mm
PS890103-8-8	3.43" 87.0 mm	2.84" 72.0 mm	1.78" 45.1 mm	2.64" 67.1 mm	1.73" 44.0 mm	1/2-14 NPTF	3/4-16 UNF	1.12" 28.6 mm	.88" 22.2 mm
PS1290103-12-12	3.66" 93.0 mm	3.00" 76.1 mm	2.24" 56.9 mm	3.86" 85.3 mm	2.17" 55.2 mm	3/4-14 NPTF	1-1/16-12 UN	1.38" 35.0 mm	1.25" 31.8 mm
PS1690103-16-16	4.41" 112.0 mm	3.54" 90.0 mm	2.42" 61.3 mm	3.66" 92.9 mm	2.48" 63.0 mm	1-11 1/2 NPTF	1-5/16-12 UN	1.62" 41.3 mm	1.50" 38.1 mm

Male Pipe - Male SAE O-Ring Straight Thread

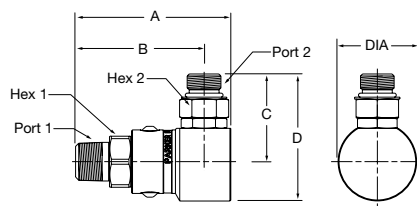

Part Number	A	B	C	D	Diameter	Port 1	Port 2	Wrench Flats 1	Wrench Flats 2
PS490105-4-4	2.85" 72.3 mm	2.44" 62.0 mm	1.38" 35.0 mm	1.98" 50.2 mm	1.20" 30.5 mm	1/4-18 NPTF	7/16-20 UNF	.75" 19.0 mm	.56" 14.3 mm
PS690105-6-6	3.05" 77.4 mm	2.54" 64.4 mm	1.55" 39.4 mm	2.20" 55.8 mm	1.29" 32.8 mm	3/8-18 NPTF	9/16-18 UNF	.88" 22.2 mm	.69" 17.5 mm
PS890105-8-8	3.43" 87.0 mm	2.84" 72.0 mm	1.86" 47.2 mm	2.72" 69.2 mm	1.73" 44.0 mm	1/2-14 NPTF	3/4-16 UNF	1.12" 28.6 mm	.88" 22.2 mm
PS1290105-12-12	3.66" 93.0 mm	3.00" 76.1 mm	2.40" 61.0 mm	3.49" 88.5 mm	2.17" 55.2 mm	3/4-14 NPTF	1-1/16-12 UN	1.38" 35.0 mm	1.25" 31.8 mm
PS1690105-16-16	4.41" 112.0 mm	3.54" 90.0 mm	2.50" 63.4 mm	3.74" 94.9 mm	2.48" 63.0 mm	1-11 1/2 NPTF	1-5/16-12 UN	1.62" 41.3 mm	1.50" 38.1 mm

D Swivels

Male Pipe - Female 37° Flare

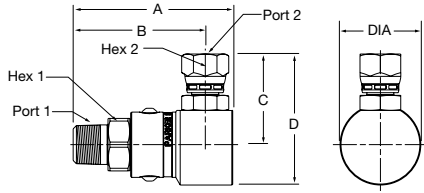

Part Number	A	B	C	D	Diameter	Port 1	Port 2	Wrench Flats 1	Wrench Flats 2
PS490106-4-4	2.85" 72.3 mm	2.44" 62.0 mm	1.47" 37.3 mm	2.07" 52.5 mm	1.20" 30.5 mm	1/4-18 NPTF	7/16-20 UNF	.75" 19.0 mm	.56" 14.3 mm
PS690106-6-6	3.05" 77.4 mm	2.54" 64.4 mm	1.57" 39.9 mm	2.22" 56.3 mm	1.29" 32.8 mm	3/8-18 NPTF	9/16-18 UNF	.88" 22.2 mm	.69" 17.5 mm
PS890106-8-8	3.43" 87.0 mm	2.84" 72.0 mm	1.91" 48.4 mm	2.77" 70.4 mm	1.73" 44.0 mm	1/2-14 NPTF	3/4-16 UNF	1.12" 28.6 mm	.88" 22.2 mm
PS1290106-12-12	3.66" 93.0 mm	3.00" 76.1 mm	2.34" 59.4 mm	3.43" 87.0 mm	2.17" 55.2 mm	3/4-14 NPTF	1-1/16-12 UN	1.38" 35.0 mm	1.25" 31.8 mm
PS1690106-16-16	4.41" 112.0 mm	3.54" 90.0 mm	2.54" 64.6 mm	3.79" 96.2 mm	2.48" 63.0 mm	1-11 1/2 NPTF	1-5/16-12 UN	1.62" 41.3 mm	1.50" 38.1 mm

Male Pipe - Female NPSM Pipe Swivel

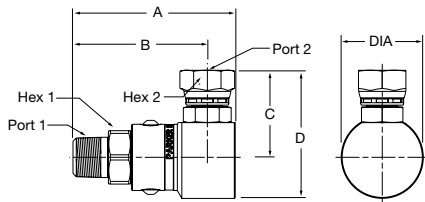

Part Number	A	B	C	D	Diameter	Port 1	Port 2	Wrench Flats 1	Wrench Flats 2
PS490107-4-4	2.85" 72.3 mm	2.44" 62.0 mm	1.48" 37.5 mm	2.08" 52.8 mm	1.20" 30.5 mm	1/4-18 NPTF	1/4-18 NPSM	.75" 19.0 mm	.69" 17.4 mm
PS690107-6-6	3.05" 77.4 mm	2.54" 64.4 mm	1.51" 38.4 mm	2.16" 54.8 mm	1.29" 32.8 mm	3/8-18 NPTF	3/8-18 NPSM	.88" 22.2 mm	.88" 22.2 mm
PS890107-8-8	3.43" 87.0 mm	2.84" 72.0 mm	1.86" 47.2 mm	2.72" 69.2 mm	1.73" 44.0 mm	1/2-14 NPTF	1/2-14 NPSM	1.12" 28.6 mm	1.00" 25.4 mm
PS1290107-12-12	3.66" 93.0 mm	3.00" 76.1 mm	2.24" 56.9 mm	3.33" 84.5 mm	2.17" 55.2 mm	3/4-14 NPTF	3/4-14 NPSM	1.38" 35.0 mm	1.25" 31.8 mm
PS1690107-16-16	4.41" 112.0 mm	3.54" 90.0 mm	2.48" 63.1 mm	3.73" 94.6 mm	2.48" 63.0 mm	1-11 1/2 NPTF	1-11 1/2 NPSM	1.62" 41.3 mm	1.50" 38.1 mm

D Swivels

Male Pipe - Female SAE Straight Thread

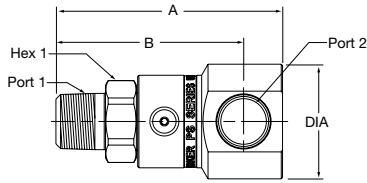

Part Number	A	B	Diameter	Port 1	Port 2	Wrench Flats 1
PS490110-4-4	2.85" 72.3 mm	2.44" 62.0 mm	1.20" 30.5 mm	1/4-18 NPTF	7/16-20 UNF	.75" 19.0 mm
PS690110-6-6	3.05" 77.4 mm	2.54" 64.4 mm	1.29" 32.8 mm	3/8-18 NPTF	9/16-18 UNF	.88" 22.2 mm
PS890110-8-8	3.43" 87.0 mm	2.84" 72.0 mm	1.73" 44.0 mm	1/2-14 NPTF	3/4-16 UNF	1.12" 28.6 mm
PS1290110-12-12	3.66" 93.0 mm	3.00" 76.1 mm	2.17" 55.2 mm	3/4-14 NPTF	1-1/16-12 UN	1.38" 35.0 mm
PS1690110-16-16	4.41" 112.0 mm	3.54" 90.0 mm	2.48" 63.0 mm	1-11 1/2 NPTF	1-5/16-12 UN	1.62" 41.3 mm

Male Pipe - O-Ring Face Seal

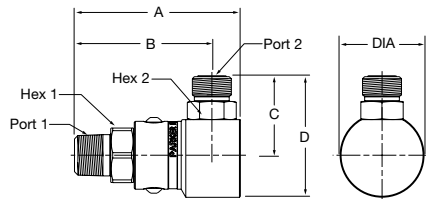

Part Number	A	B	C	D	Diameter	Port 1	Port 2	Wrench Flats 1	Wrench Flats 2
PS4901JM-4-4	2.85" 72.3 mm	2.44" 62.0 mm	1.29" 32.5 mm	1.89" 47.9 mm	1.20" 30.5 mm	1/4-18 NPTF	9/16-18 UNF	.75" 19.0 mm	.56" 14.3 mm
PS6901JM-6-6	3.05" 77.4 mm	2.54" 64.4 mm	1.40" 35.6 mm	2.05" 52.0 mm	1.29" 32.8 mm	3/8-18 NPTF	11/16-16 UN	.88" 22.2 mm	.69" 17.5 mm
PS8901JM-8-8	3.43" 87.0 mm	2.84" 72.0 mm	1.74" 44.1 mm	2.60" 66.1 mm	1.73" 44.0 mm	1/2-14 NPTF	13/16-16 UN	1.12" 28.6 mm	.88" 22.2 mm
PS12901JM-12-12	3.66" 93.0 mm	3.00" 76.1 mm	2.18" 55.4 mm	3.27" 83.0 mm	2.17" 55.2 mm	3/4-14 NPTF	1-3/16-12 UN	1.38" 35.0 mm	1.25" 31.8 mm
PS16901JM-16-16	4.41" 112.0 mm	3.54" 90.0 mm	2.34" 59.6 mm	3.59" 91.1 mm	2.48" 63.0 mm	1-11 1/2 NPTF	1-7/16-12 UN	1.62" 41.3 mm	1.50" 38.1 mm

Female Pipe - Female Pipe

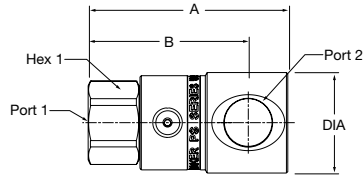

Part Number	A	B	Diameter	Port 1	Port 2	Wrench Flats 1
PS490202-4-4	2.42" 61.4 mm	2.01" 51.2 mm	1.20" 30.5 mm	1/4-18 NPTF	1/4-18 NPTF	.75" 19.0 mm
PS690202-6-6	2.68" 68.2 mm	2.17" 55.2 mm	1.29" 32.8 mm	3/8-18 NPTF	3/8-18 NPTF	.88" 22.2 mm
PS890202-8-8	2.96" 75.3 mm	2.37" 60.3 mm	1.49" 37.8 mm	1/2-14 NPTF	1/2-14 NPTF	1.12" 28.6 mm
PS1290202-12-12	3.43" 87.2 mm	2.77" 70.4 mm	1.76" 44.6 mm	3/4-14 NPTF	3/4-14 NPTF	1.38" 35.0 mm
PS1690202-16-16	4.03" 102.3 mm	3.16" 80.3 mm	2.16" 54.9 mm	1-11 1/2 NPTF	1-11 1/2 NPTF	1.62" 41.3 mm

3 Piece Design

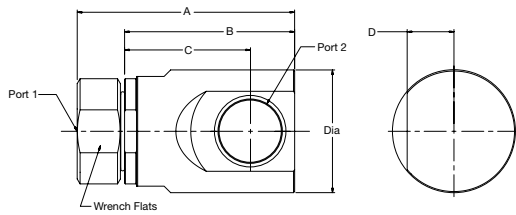

Part Number	A	B	C	D	Diameter	Port 1	Port 2	Wrench Flats
PS2490202-20-20	5.91" 150.2 mm	4.63" 117.5 mm	3.43" 87.0 mm	1.27" 32.3 mm	3.36" 85.2 mm	1 1/4-11 1/2 NPTF	1 1/4-11 1/2 NPTF	2.63" 66.7 mm
PS2490202-24-24	5.91" 150.2 mm	4.63" 117.5 mm	3.43" 87.0 mm	1.27" 32.3 mm	3.36" 85.2 mm	1 1/2-11 1/2 NPTF	1 1/2-11 1/2 NPTF	2.63" 66.7 mm
PS3290202-32-32	6.75" 171.5 mm	5.45" 138.4 mm	3.93" 99.7 mm	1.52" 38.5 mm	4.19" 106.4 mm	2 11-1/2 NPTF	2 11-1/2 NPTF	3.06" 77.6 mm

D Swivels

Female Pipe - Male 37° Flare

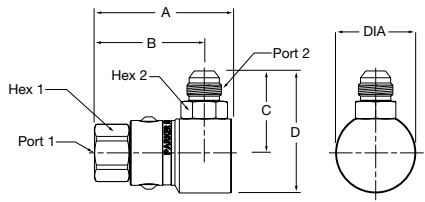

Part Number	A	B	C	D	Diameter	Port 1	Port 2	Wrench Flat 1	Wrench Flat 2
PS490203-4-4	2.42" 61.4 mm	2.01" 51.2 mm	1.39" 35.2 mm	1.99" 50.5 mm	1.20" 30.5 mm	1/4-18 NPTF	7/16-20 UNF	.75" 19.0 mm	.56" 14.3 mm
PS690203-6-6	2.68" 68.2 mm	2.17" 55.2 mm	1.44" 36.6 mm	2.09" 53.0 mm	1.29" 32.8 mm	3/8-18 NPTF	9/16-18 UNF	.88" 22.2 mm	.69" 17.5 mm
PS890203-8-8	2.96" 75.3 mm	2.37" 60.3 mm	1.78" 45.1 mm	2.64" 67.1 mm	1.73" 44.0 mm	1/2-14 NPTF	3/4-16 UNF	1.12" 28.6 mm	.88" 22.2 mm
PS1290203-12-12	3.43" 87.2 mm	2.77" 70.4 mm	2.24" 56.9 mm	3.86" 85.3 mm	2.17" 55.2 mm	3/4-14 NPTF	1-1/16-12 UN	1.38" 35.0 mm	1.25" 31.8 mm
PS1690203-16-16	4.03" 102.3 mm	3.16" 80.3 mm	2.42" 61.3 mm	3.66" 92.9 mm	2.48" 63.0 mm	1-11 1/2 NPTF	1-5/16-12 UN	1.62" 41.3 mm	1.50" 38.1 mm

3 Piece Design

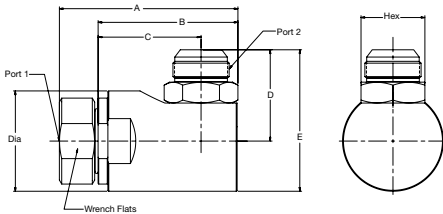

Part Number	A	B	C	D	E	Port 1	Port 2	Wrench Flats 1	Wrench Flats 2	Wrench Flats 3
PS2490203-20-20	5.91" 150.2 mm	4.63" 117.5 mm	3.43" 87.0 mm	2.85" 72.4 mm	4.53" 115.0 mm	1 1/4-11 1/2 NPTF	1 5/8-12 UN	1.88" 47.6 mm	2.63" 66.7 mm	3.36" 85.2 mm
PS2490203-24-24	5.94" 150.9 mm	4.65" 118.2 mm	3.43" 87.0 mm	3.05" 77.6 mm	4.73" 120.2 mm	1 1/2-11 1/2 NPTF	17/8-12 UN	2.13" 54.0 mm	2.63" 66.7 mm	3.36" 85.2 mm
PS3290203-32-32	6.82" 173.1 mm	5.51" 140.0 mm	3.93" 99.7 mm	3.70" 94.0 mm	5.80" 147.2 mm	2 11-1/2 NPTF	2 1/2-12 UN	2.75" 69.8 mm	3.06" 77.6 mm	4.19" 106.4 mm

Female Pipe - Male SAE O-Ring Straight Thread

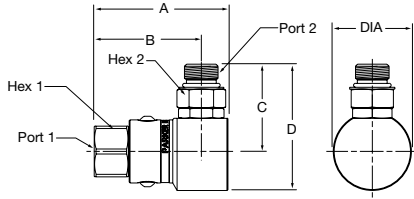

Part Number	A	B	C	D	Diameter	Port 1	Port 2	Wrench Flats 1	Wrench Flats 2
PS490205-4-4	2.42" 61.4 mm	2.01" 51.2 mm	1.38" 35.0 mm	1.98" 50.2 mm	1.20" 30.5 mm	1/4-18 NPTF	7/16-20 UNF	.75" 19.0 mm	.56" 14.3 mm
PS690205-6-6	2.68" 68.2 mm	2.17" 55.2 mm	1.55" 39.4 mm	2.20" 55.8 mm	1.29" 32.8 mm	3/8-18 NPTF	9/16-18 UNF	.88" 22.2 mm	.69" 17.5 mm
PS890205-8-8	2.96" 75.3 mm	2.37" 60.3 mm	1.86" 47.2 mm	2.72" 69.2 mm	1.73" 44.0 mm	1/2-14 NPTF	3/4-16 UNF	1.12" 28.6 mm	.88" 22.2 mm
PS1290205-12-12	3.43" 87.2 mm	2.77" 70.4 mm	2.40" 61.0 mm	3.49" 88.5 mm	2.17" 55.2 mm	3/4-14 NPTF	1-1/16-12 UN	1.38" 35.0 mm	1.25" 31.8 mm
PS1690205-16-16	4.03" 102.3 mm	3.16" 80.3 mm	2.50" 63.4 mm	3.74" 94.9 mm	2.48" 63.0 mm	1-11 1/2 NPTF	1-5/16-12 UN	1.62" 41.3 mm	1.50" 38.1 mm

Female Pipe - Female 37° Flare

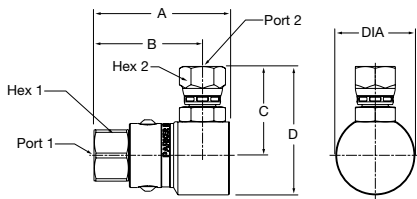

Part Number	A	B	C	D	Diameter	Port 1	Port 2	Wrench Flats 1	Wrench Flats 2
PS490206-4-4	2.42" 61.4 mm	2.01" 51.2 mm	1.47" 37.3 mm	2.07" 52.5 mm	1.20" 30.5 mm	1/4-18 NPTF	7/16-20 UNF	.75" 19.0 mm	.56" 14.3 mm
PS690206-6-6	2.68" 68.2 mm	2.17" 55.2 mm	1.57" 39.9 mm	2.22" 56.3 mm	1.29" 32.8 mm	3/8-18 NPTF	9/16-18 UNF	.88" 22.2 mm	.69" 17.5 mm
PS890206-8-8	2.96" 75.3 mm	2.37" 60.3 mm	1.91" 48.4 mm	2.77" 70.4 mm	1.73" 44.0 mm	1/2-14 NPTF	3/4-16 UNF	1.12" 28.6 mm	.88" 22.2 mm
PS1290206-12-12	3.43" 87.2 mm	2.77" 70.4 mm	2.34" 59.4 mm	3.43" 87.0 mm	2.17" 55.2 mm	3/4-14 NPTF	1-1/16-12 UN	1.38" 35.0 mm	1.25" 31.8 mm
PS1690206-16-16	4.03" 102.3 mm	3.16" 80.3 mm	2.54" 64.6 mm	3.79" 96.2 mm	2.48" 63.0 mm	1-11 1/2 NPTF	1-5/16-12 UN	1.62" 41.3 mm	1.50" 38.1 mm

Female Pipe - Female NPSM Pipe Swivel

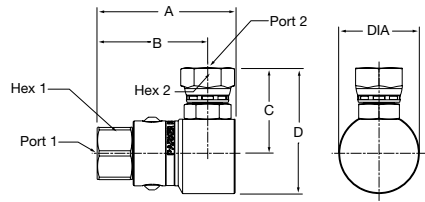

Part Number	A	B	C	D	Diameter	Port 1	Port 2	Wrench Flats 1	Wrench Flats 2
PS490207-4-4	2.42" 61.4 mm	2.01" 51.2 mm	1.48" 37.5 mm	2.08" 52.8 mm	1.20" 30.5 mm	1/4-18 NPTF	1/4-18 NPSM	.75" 19.0 mm	.69" 17.4 mm
PS690207-6-6	2.68" 68.2 mm	2.17" 55.2 mm	1.51" 38.4 mm	2.16" 54.8 mm	1.29" 32.8 mm	3/8-18 NPTF	3/8-18 NPSM	.88" 22.2 mm	.88" 22.2 mm
PS890207-8-8	2.96" 75.3 mm	2.37" 60.3 mm	1.86" 47.2 mm	2.72" 69.2 mm	1.73" 44.0 mm	1/2-14 NPTF	1/2-14 NPSM	1.12" 28.6 mm	1.00" 25.4 mm
PS1290207-12-12	3.43" 87.2 mm	2.77" 70.4 mm	2.24" 56.9 mm	3.33" 84.5 mm	2.17" 55.2 mm	3/4-14 NPTF	3/4-14 NPSM	1.38" 35.0 mm	1.25" 31.8 mm
PS1690207-16-16	4.03" 102.3 mm	3.16" 80.3 mm	2.48" 63.1 mm	3.73" 94.6 mm	2.48" 63.0 mm	1-11 1/2 NPTF	1-11 1/2 NPSM	1.62" 41.3 mm	1.50" 38.1 mm

Female Pipe - Female SAE Straight Thread

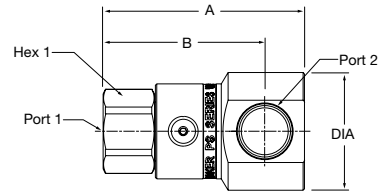

Part Number	A	B	Port 1	Port 2	Wrench Flats 1	Wrench Flats 2
PS490210-4-4	2.42" 61.4 mm	2.01" 51.2 mm	1/4-18 NPTF	7/16-20 UNF	1.20" 30.5 mm	.75" 19.0 mm
PS690210-6-6	2.68" 68.2 mm	2.17" 55.2 mm	3/8-18 NPTF	9/16-18 UNF	1.29" 32.8 mm	.88" 22.2 mm
PS890210-8-8	2.96" 75.3 mm	2.37" 60.3 mm	1/2-14 NPTF	3/4-16 UNF	1.73" 44.0 mm	1.12" 28.6 mm
PS1290210-12-12	3.43" 87.2 mm	2.77" 70.4 mm	3/4-14 NPTF	1-1/16-12 UN	2.17" 55.2 mm	1.38" 35.0 mm
PS1690210-16-16	4.03" 102.3 mm	3.16" 80.3 mm	1-11 1/2 NPTF	1-5/16-12 UN	2.48" 63.0 mm	1.62" 41.3 mm

3 Piece Design

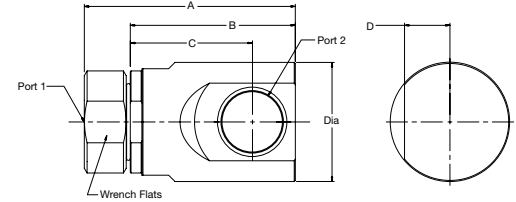

Part Number	A	B	C	D	Diameter	Port 1	Port 2	Wrench Flats
PS2490210-20-20	5.91" 150.2 mm	4.63" 117.5 mm	3.43" 87.0 mm	1.27" 32.3 mm	3.36" 85.2 mm	1 1/4-11 1/2 NPTF	1 5/8-12 UN	2.63" 66.7 mm
PS2490210-24-24	5.91" 150.2 mm	4.63" 117.5 mm	3.43" 87.0 mm	1.27" 32.3 mm	3.36" 85.2 mm	1 1/4-11 1/2 NPTF	1 5/8-12 UN	2.63" 66.7 mm
PS3290210-32-32	6.75" 171.5 mm	5.45" 138.4 mm	3.93" 99.7 mm	1.52" 38.5 mm	4.19" 106.4 mm	2 11-1/2 NPTF	2-1/2-12 UN	3.06" 77.6 mm

Male 37° Flare - Female Pipe

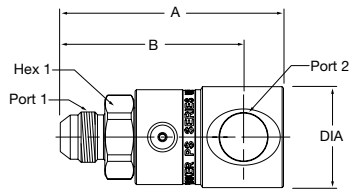

Part Number	A	B	Port 1	Port 2	Wrench Flats 1	Wrench Flats 2
PS490302-4-4	2.85" 72.3 mm	2.44" 62.0 mm	7/16-20 UNF	1/4-18 NPTF	1.20" 30.5 mm	.75" 19.0 mm
PS690302-6-6	3.05" 77.4 mm	2.54" 64.4 mm	9/16-18 UNF	3/8-18 NPTF	1.29" 32.8 mm	.88" 22.2 mm
PS890302-8-8	3.29" 83.7 mm	2.70" 68.7 mm	3/4-16 UNF	1/2-14 NPTF	1.49" 37.8 mm	1.12" 28.6 mm
PS1290302-12-12	3.76" 95.6 mm	3.10" 78.8 mm	1-1/16-12 UN	3/4-14 NPTF	1.76" 44.6 mm	1.38" 35.0 mm
PS1690302-16-16	4.41" 112.0 mm	3.54" 90.0 mm	1-5/16-12 UN	1-11 1/2 NPTF	2.16" 54.9 mm	1.62" 41.3 mm

3 Piece Design

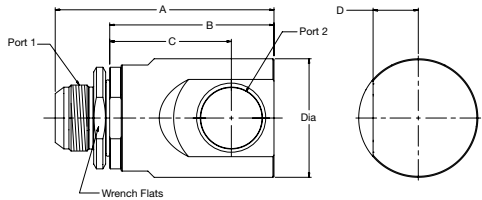

Part Number	A	B	C	D	Diameter	Port 1	Port 2	Wrench Flats
PS2490302-20-20	6.16" 150.2 mm	4.63" 117.5 mm	3.43" 87.0 mm	1.27" 32.3 mm	3.36" 85.2 mm	1 5/8-12 UN	1 1/4-11 1/2 NPTF	2.63" 66.7 mm
PS2490302-24-24	6.16" 150.2 mm	4.63" 117.5 mm	3.43" 87.0 mm	1.27" 32.3 mm	3.36" 85.2 mm	1 7/8-12 UN	1 1/2-11 1/2 NPTF	2.63" 66.7 mm
PS3290302-32-32	7.38" 187.4 mm	5.45" 138.4 mm	3.93" 99.7 mm	1.52" 38.5 mm	4.19" 106.4 mm	2 1/2-12 UN	2-11-1/2 NPTF	3.06" 77.6 mm

Male 37° Flare - Male 37° Flare

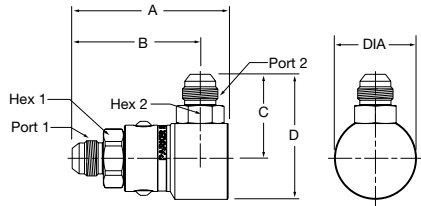

Part Number	A	B	C	D	Diameter	Port 1	Port 2	Wrench Flats 1	Wrench Flats 2
PS490303-4-4	2.85" 72.3 mm	2.44" 62.0 mm	1.39" 35.2 mm	1.99" 50.5 mm	1.20" 30.5 mm	7/16-20 UNF	7/16-20 UNF	.75" 19.0 mm	.56" 14.3 mm
PS690303-6-6	3.05" 77.4 mm	2.54" 64.4 mm	1.44" 36.6 mm	2.09" 53.0 mm	1.29" 32.8 mm	9/16-18 UNF	9/16-18 UNF	.88" 22.2 mm	.69" 17.5 mm
PS890303-8-8	3.29" 83.7 mm	2.70" 68.7 mm	1.78" 45.1 mm	2.64" 67.1 mm	1.73" 44.0 mm	3/4-16 UNF	3/4-16 UNF	1.12" 28.6 mm	.88" 22.2 mm
PS890303-10-10	3.39" 86.2 mm	2.80" 71.2 mm	1.90" 48.4 mm	2.77" 70.4 mm	1.73" 44.0 mm	7/8-14 UNF	7/8-14 UNF	1.12" 28.6 mm	.88" 22.2 mm
PS1290303-12-12	3.76" 95.6 mm	3.10" 78.8 mm	2.24" 56.9 mm	3.86" 85.3 mm	2.17" 55.2 mm	1-1/16-12 UN	1-1/16-12 UN	1.38" 35.0 mm	1.25" 31.8 mm
PS1690303-16-16	4.41" 112.0 mm	3.54" 90.0 mm	2.42" 61.3 mm	3.66" 92.9 mm	2.48" 63.0 mm	1-5/16-12 UN	1-5/16-12 UN	1.62" 41.3 mm	1.50" 38.1 mm

3 Piece Design

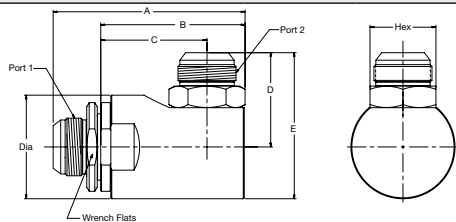

Part Number	A	B	C	D	E	Diameter	Port 1	Port 2	Wrench Flats 1	Wrench Flats 2
PS2490303-20-20	6.16" 156.4 mm	4.63" 117.5 mm	3.43" 87.0 mm	2.85" 72.4 mm	4.53" 115.0 mm	3.36" 85.2 mm	1 5/8-12 UN	1 5/8-12 UN	1.88" 47.6 mm	2.63" 66.7 mm
PS2490303-24-24	5.81" 157.1 mm	4.65" 118.2 mm	3.43" 87.0 mm	3.05" 77.6 mm	4.73" 120.2 mm	3.36" 85.2 mm	1 7/8-12 UN	1 7/8-12 UN	2.13" 54.0 mm	2.63" 66.7 mm
PS3290303-32-32	7.44" 189.0 mm	5.51" 140.0 mm	3.93" 99.7 mm	3.70" 94.0 mm	5.80" 147.2 mm	4.19" 106.4 mm	2 1/2-12 UN	2 1/2-12 UN	2.75" 69.8 mm	3.06" 77.6 mm

Male 37° Flare - Male SAE O-Ring Straight Thread

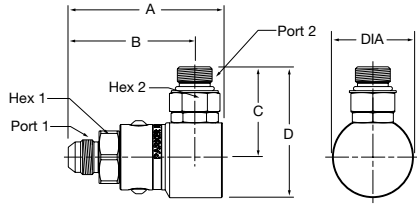

Part Number	A	B	C	D	Diameter	Port 1	Port 2	Wrench Flats 1	Wrench Flats 2
PS490305-4-4	2.85" 72.3 mm	2.44" 62.0 mm	1.38" 35.0 mm	1.98" 50.2 mm	1.20" 30.5 mm	7/16-20 UNF	7/16-20 UNF	.75" 19.0 mm	.56" 14.3 mm
PS690305-6-6	3.05" 77.4 mm	2.54" 64.4 mm	1.55" 39.4 mm	2.20" 55.8 mm	1.29" 32.8 mm	9/16-18 UNF	9/16-18 UNF	.88" 22.2 mm	.69" 17.5 mm
PS890305-8-8	3.29" 83.7 mm	2.70" 68.7 mm	1.86" 47.2 mm	2.72" 69.2 mm	1.73" 44.0 mm	3/4-16 UNF	3/4-16 UNF	1.12" 28.6 mm	.88" 22.2 mm
PS1290305-12-12	3.76" 95.6 mm	3.10" 78.8 mm	2.40" 61.0 mm	3.49" 88.5 mm	2.17" 55.2 mm	1-1/16-12 UN	1-1/16-12 UN	1.38" 35.0 mm	1.25" 31.8 mm
PS1690305-16-16	4.41" 112.0 mm	3.54" 90.0 mm	2.50" 63.4 mm	3.74" 94.9 mm	2.48" 63.0 mm	1-5/16-12 UN	1-5/16-12 UN	1.62" 41.3 mm	1.50" 38.1 mm

Male 37° Flare - Female 37° Flare

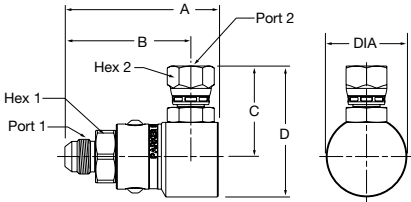

Part Number	A	B	C	D	Diameter	Port 1	Port 2	Wrench Flats 1	Wrench Flats 2
PS490306-4-4	2.85" 72.3 mm	2.44" 62.0 mm	1.47" 37.3 mm	2.07" 52.5 mm	1.20" 30.5 mm	7/16-20 UNF	7/16-20 UNF	.75" 19.0 mm	.56" 14.3 mm
PS690306-6-6	3.05" 77.4 mm	2.54" 64.4 mm	1.57" 39.9 mm	2.22" 56.3 mm	1.29" 32.8 mm	9/16-18 UNF	9/16-18 UNF	.88" 22.2 mm	.69" 17.5 mm
PS890306-8-8	3.29" 83.7 mm	2.70" 68.7 mm	1.91" 48.4 mm	2.77" 70.4 mm	1.73" 44.0 mm	3/4-16 UNF	3/4-16 UNF	1.12" 28.6 mm	.88" 22.2 mm
PS1290306-12-12	3.76" 95.6 mm	3.10" 78.8 mm	2.34" 59.4 mm	3.43" 87.0 mm	2.17" 55.2 mm	1-1/16-12 UN	1-1/16-12 UN	1.38" 35.0 mm	1.25" 31.8 mm
PS1690306-16-16	4.41" 112.0 mm	3.54" 90.0 mm	2.54" 64.6 mm	3.79" 96.2 mm	2.48" 63.0 mm	1-5/16-12 UN	1-5/16-12 UN	1.62" 41.3 mm	1.50" 38.1 mm

D Swivels

Male 37° Flare - Female NPSM Pipe Swivel

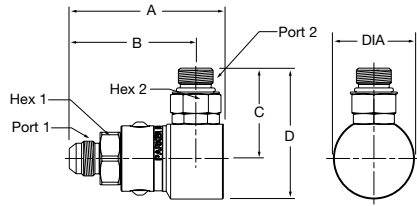

Part Number	A	B	C	D	Diameter	Port 1	Port 2	Wrench Flats 1	Wrench Flats 2
PS490307-4-4	2.85" 72.3 mm	2.44" 62.0 mm	1.48" 37.5 mm	2.08" 52.8 mm	1.20" 30.5 mm	7/16-20 UNF	1/4-18 NPSM	.75" 19.0 mm	.69" 17.4 mm
PS690307-6-6	3.05" 77.4 mm	2.54" 64.4 mm	1.51" 38.4 mm	2.16" 54.8 mm	1.29" 32.8 mm	9/16-18 UNF	3/8-18 NPSM	.88" 22.2 mm	.88" 22.2 mm
PS890307-8-8	3.29" 83.7 mm	2.70" 68.7 mm	1.86" 47.2 mm	2.72" 69.2 mm	1.73" 44.0 mm	3/4-16 UNF	1/2-14 NPSM	1.12" 28.6 mm	1.00" 25.4 mm
PS1290307-12-12	3.76" 95.6 mm	3.10" 78.8 mm	2.24" 56.9 mm	3.33" 84.5 mm	2.17" 55.2 mm	1-1/16-12 UN	3/4-14 NPSM	1.38" 35.0 mm	1.25" 31.8 mm
PS1690307-16-16	4.41" 112.0 mm	3.54" 90.0 mm	2.48" 63.1 mm	3.73" 94.6 mm	2.48" 63.0 mm	1-5/16-12 UN	1-11 1/2 NPSM	1.62" 41.3 mm	1.50" 38.1 mm

Male 37° Flare - Female SAE Straight Thread

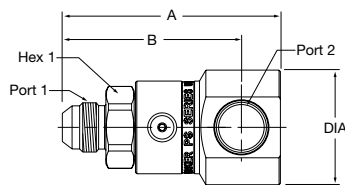

Part Number	A	B	Diameter	Port 1	Port 2	Wrench Flats
PS490310-4-4	2.85" 72.3 mm	2.44" 62.0 mm	1.20" 30.5 mm	7/16-20 UNF	7/16-20 UNF	.75" 19.0 mm
PS690310-6-6	3.05" 77.4 mm	2.54" 64.4 mm	1.29" 32.8 mm	9/16-18 UNF	9/16-18 UNF	.88" 22.2 mm
PS890310-8-8	3.29" 83.7 mm	2.70" 68.7 mm	1.73" 44.0 mm	3/4-16 UNF	3/4-16 UNF	1.12" 28.6 mm
PS1290310-12-12	3.76" 95.6 mm	3.10" 78.8 mm	2.17" 55.2 mm	1-1/16-12 UN	1-1/16-12 UN	1.38" 35.0 mm
PS1690310-16-16	4.41" 112.0 mm	3.54" 90.0 mm	2.48" 63.0 mm	1-1/16-12 UN	1-1/16-12 UN	1.62" 41.3 mm

Male SAE O-Ring Straight Thread - Female Pipe

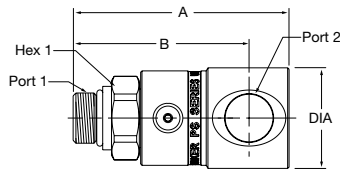

Part Number	A	B	Diameter	Port 1	Port 2	Wrench Flats
PS490502-4-4	2.70" 68.6 mm	2.29" 58.3 mm	1.20" 30.5 mm	7/16-20 UNF	1/4-18 NPTF	.75" 19.0 mm
PS690502-6-6	2.87" 72.8 mm	2.36" 59.8 mm	1.29" 32.8 mm	9/16-18 UNF	3/8-18 NPTF	.88" 22.2 mm
PS890502-8-8	3.19" 80.9 mm	2.60" 65.9 mm	1.49" 37.8 mm	3/4-16 UNF	1/2-14 NPTF	1.12" 28.6 mm
PS1290502-12-12	3.58" 90.9 mm	2.92" 74.0 mm	1.76" 44.6 mm	1-1/16-12 UN	3/4-14 NPTF	1.38" 35.0 mm
PS1690502-16-16	4.18" 106.3 mm	3.32" 84.3 mm	2.16" 54.9 mm	1-5/16-12 UN	1-11 1/2 NPTF	1.62" 41.3 mm

Male SAE O-Ring Straight Thread - Male 37° Flare

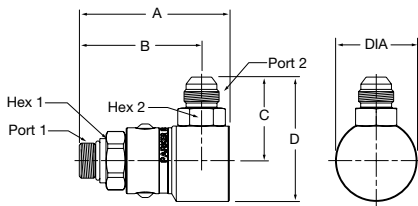

Part Number	A	B	C	D	Diameter	Port 1	Port 2	Wrench Flats 1	Wrench Flats 2
PS490503-4-4	2.70" 68.6 mm	2.29" 58.3 mm	1.39" 35.2 mm	1.99" 50.5 mm	1.20" 30.5 mm	7/16-20 UNF	7/16-20 UNF	.75" 19.0 mm	.56" 14.3 mm
PS690503-6-6	2.87" 72.8 mm	2.36" 59.8 mm	1.44" 36.6 mm	2.09" 53.0 mm	1.29" 32.8 mm	9/16-18 UNF	9/16-18 UNF	.88" 22.2 mm	.69" 17.5 mm
PS890503-8-8	3.19" 80.9 mm	2.60" 65.9 mm	1.78" 45.1 mm	2.64" 67.1 mm	1.73" 44.0 mm	3/4-16 UNF	3/4-16 UNF	1.12" 28.6 mm	.88" 22.2 mm
PS890503-10-10	3.25" 82.5 mm	2.66" 67.5 mm	1.90" 48.4 mm	2.77" 70.4 mm	1.73" 44.0 mm	7/8-14 UNF	7/8-14 UNF	1.12" 28.6 mm	.88" 22.2 mm
PS1290503-12-12	3.58" 90.9 mm	2.92" 74.0 mm	2.24" 56.9 mm	3.86" 85.3 mm	2.17" 55.2 mm	1-1/16-12 UN	1-1/16-12 UN	1.38" 35.0 mm	1.25" 31.8 mm
PS1690503-16-16	4.18" 106.3 mm	3.32" 84.3 mm	2.42" 61.3 mm	3.66" 92.9 mm	2.48" 63.0 mm	1-5/16-12 UN	1-5/16-12 UN	1.62" 41.3 mm	1.50" 38.1 mm

Male SAE O-Ring Straight Thread - Male SAE O-Ring Straight Thread

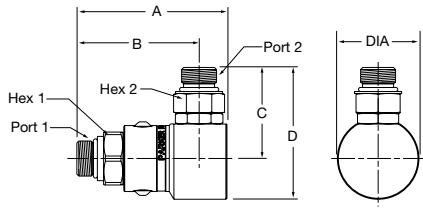

Part Number	A	B	C	D	Diameter	Port 1	Port 2	Wrench Flats 1	Wrench Flats 2
PS490505-4-4	2.70" 68.6 mm	2.29" 58.3 mm	1.38" 35.0 mm	1.98" 50.2 mm	1.20" 30.5 mm	7/16-20 UNF	7/16-20 UNF	.75" 19.0 mm	.56" 14.3 mm
PS690505-6-6	2.87" 72.8 mm	2.36" 59.8 mm	1.55" 39.4 mm	2.20" 55.8 mm	1.29" 32.8 mm	9/16-18 UNF	9/16-18 UNF	.88" 22.2 mm	.69" 17.5 mm
PS890505-8-8	3.19" 80.9 mm	2.60" 65.9 mm	1.86" 47.2 mm	2.72" 69.2 mm	1.73" 44.0 mm	3/4-16 UNF	3/4-16 UNF	1.12" 28.6 mm	.88" 22.2 mm
PS1290505-12-12	3.58" 90.9 mm	2.92" 74.0 mm	2.40" 61.0 mm	3.49" 88.5 mm	2.17" 55.2 mm	1-1/16-12 UN	1-1/16-12 UN	1.38" 35.0 mm	1.25" 31.8 mm
PS1690505-16-16	4.18" 106.3 mm	3.32" 84.3 mm	2.50" 63.4 mm	3.74" 94.9 mm	2.48" 63.0 mm	1-5/16-12 UN	1-5/16-12 UN	1.62" 41.3 mm	1.50" 38.1 mm

Male SAE O-Ring Straight Thread - Female 37° Flare

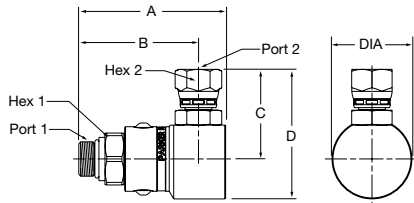

Part Number	A	B	C	D	Diameter	Port 1	Port 2	Wrench Flats 1	Wrench Flats 2
PS490506-4-4	2.70" 68.6 mm	2.29" 58.3 mm	1.47" 37.3 mm	2.07" 52.5 mm	1.20" 30.5 mm	7/16-20 UNF	7/16-20 UNF	.75" 19.0 mm	.56" 14.3 mm
PS690506-6-6	2.87" 72.8 mm	2.36" 59.8 mm	1.57" 39.9 mm	2.22" 56.3 mm	1.29" 32.8 mm	9/16-18 UNF	9/16-18 UNF	.88" 22.2 mm	.69" 17.5 mm
PS890506-8-8	3.19" 80.9 mm	2.60" 65.9 mm	1.91" 48.4 mm	2.77" 70.4 mm	1.73" 44.0 mm	3/4-16 UNF	3/4-16 UNF	1.12" 28.6 mm	.88" 22.2 mm
PS1290506-12-12	3.58" 90.9 mm	2.92" 74.0 mm	2.34" 59.4 mm	3.43" 87.0 mm	2.17" 55.2 mm	1-1/16-12 UN	1-1/16-12 UN	1.38" 35.0 mm	1.25" 31.8 mm
PS1690506-16-16	4.18" 106.3 mm	3.32" 84.3 mm	2.54" 64.6 mm	3.79" 96.2 mm	2.48" 63.0 mm	1-5/16-12 UN	1-5/16-12 UN	1.62" 41.3 mm	1.50" 38.1 mm

Male SAE O-Ring Straight Thread - Female NPSM Pipe Swivel

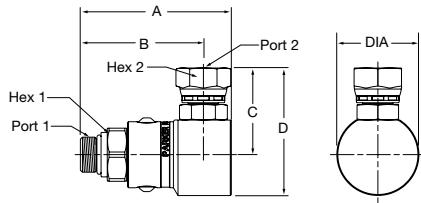

Part Number	A	B	C	D	Diameter	Port 1	Port 2	Wrench Flats 1	Wrench Flats 2
PS490507-4-4	2.70" 68.6 mm	2.29" 58.3 mm	1.48" 37.5 mm	2.08" 52.8 mm	1.20" 30.5 mm	7/16-20 UNF	1/4-18 NPSM	.75" 19.0 mm	.69" 17.4 mm
PS690507-6-6	2.87" 72.8 mm	2.36" 59.8 mm	1.51" 38.4 mm	2.16" 54.8 mm	1.29" 32.8 mm	9/16-18 UNF	3/8-18 NPSM	.88" 22.2 mm	.88" 22.2 mm
PS890507-8-8	3.19" 80.9 mm	2.60" 65.9 mm	1.86" 47.2 mm	2.72" 69.2 mm	1.73" 44.0 mm	3/4-16 UNF	1/2-14 NPSM	1.12" 28.6 mm	1.00" 25.4 mm
PS1290507-12-12	3.58" 90.9 mm	2.92" 74.0 mm	2.24" 56.9 mm	3.33" 84.5 mm	2.17" 55.2 mm	1-1/16-12 UN	3/4-14 NPSM	1.38" 35.0 mm	1.25" 31.8 mm
PS1690507-16-16	4.18" 106.3 mm	3.32" 84.3 mm	2.48" 63.1 mm	3.73" 94.6 mm	2.48" 63.0 mm	1-5/16-12 UN	1-11/2 NPSM	1.62" 41.3 mm	1.50" 38.1 mm

Male SAE O-Ring Straight Thread - Female SAE Straight Thread

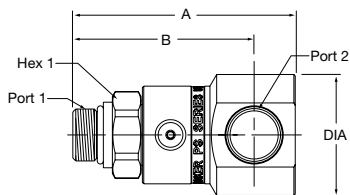

Part Number	A	B	Diameter	Port 1	Port 2	Wrench Flats
PS490510-4-4	2.70" 68.6 mm	2.29" 58.3 mm	1.20" 30.5 mm	7/16-20 UNF	7/16-20 UNF	.75" 19.0 mm
PS690510-6-6	2.87" 72.8 mm	2.36" 59.8 mm	1.29" 32.8 mm	9/16-18 UNF	9/16-18 UNF	.88" 22.2 mm
PS890510-8-8	3.19" 80.9 mm	2.60" 65.9 mm	1.73" 44.0 mm	3/4-16 UNF	3/4-16 UNF	1.12" 28.6 mm
PS1290510-12-12	3.58" 90.9 mm	2.92" 74.0 mm	2.17" 55.2 mm	1-1/16-12 UN	1-1/16-12 UN	1.38" 35.0 mm
PS1690510-16-16	4.18" 106.3 mm	3.32" 84.3 mm	2.48" 63.0 mm	1-5/16-12 UN	1-5/16-12 UN	1.62" 41.3 mm

Female SAE Straight Thread - Female Pipe

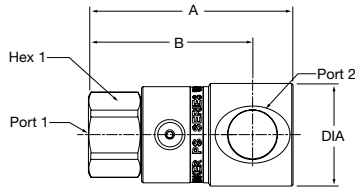

Part Number	A	B	Diameter	Port 1	Port 2	Wrench Flats
PS491002-4-4	2.42" 61.4 mm	2.01" 51.2 mm	1.20" 30.5 mm	7/16-20 UNF	1/4-18 NPTF	.75" 19.0 mm
PS691002-6-6	2.68" 68.2 mm	2.17" 55.2 mm	1.29" 32.8 mm	9/16-18 UNF	3/8-18 NPTF	.88" 22.2 mm
PS891002-8-8	2.96" 75.3 mm	2.37" 60.3 mm	1.49" 37.8 mm	3/4-16 UNF	1/2-14 NPTF	1.12" 28.6 mm
PS1291002-12-12	3.43" 87.2 mm	2.77" 70.4 mm	1.76" 44.6 mm	1-1/16-12 UN	3/4-14 NPTF	1.38" 35.0 mm
PS1691002-16-16	4.03" 102.3 mm	3.16" 80.3 mm	2.16" 54.9 mm	1-5/16-12 UN	1-11/2 NPTF	1.62" 41.3 mm

Female SAE Straight Thread - Male 37° Flare

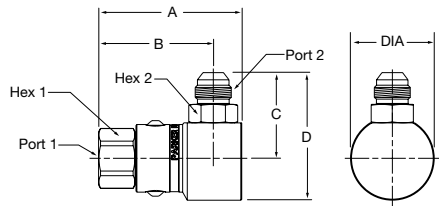

Part Number	A	B	C	D	Diameter	Port 1	Port 2	Wrench Flats 1	Wrench Flats 2
PS491003-4-4	2.42" 61.4 mm	2.01" 51.2 mm	1.39" 35.2 mm	1.99" 50.5 mm	1.20" 30.5 mm	7/16-20 UNF	7/16-20 UNF	.75" 19.0 mm	.56" 14.3 mm
PS691003-6-6	2.68" 68.2 mm	2.17" 55.2 mm	1.44" 36.6 mm	2.09" 53.0 mm	1.29" 32.8 mm	9/16-18 UNF	9/16-18 UNF	.88" 22.2 mm	.69" 17.5 mm
PS891003-8-8	2.96" 75.3 mm	2.37" 60.3 mm	1.78" 45.1 mm	2.64" 67.1 mm	1.73" 44.0 mm	3/4-16 UNF	3/4-16 UNF	1.12" 28.6 mm	.88" 22.2 mm
PS1291003-12-12	3.43" 87.2 mm	2.77" 70.4 mm	2.24" 56.9 mm	3.86" 85.3 mm	2.17" 55.2 mm	1-1/16-12 UN	1-1/16-12 UN	1.38" 35.0 mm	1.25" 31.8 mm
PS1691003-16-16	4.03" 102.3 mm	3.16" 80.3 mm	2.42" 61.3 mm	3.66" 92.9 mm	2.48" 63.0 mm	1-5/16-12 UN	1-5/16-12 UN	1.62" 41.3 mm	1.50" 38.1 mm

D Swivels

Female SAE Straight Thread - Male SAE O-Ring Straight Thread

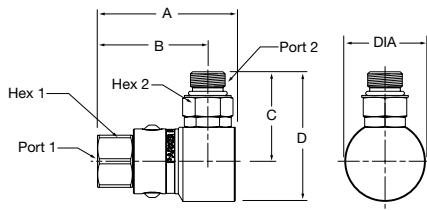

Part Number	A	B	C	D	Diameter	Port 1	Port 2	Wrench Flats 1	Wrench Flats 2
PS491005-4-4	2.42" 61.4 mm	2.01" 51.2 mm	1.38" 35.0 mm	1.98" 50.2 mm	1.20" 30.5 mm	7/16-20 UNF	7/16-20 UNF	.75" 19.0 mm	.56" 14.3 mm
PS691005-6-6	2.68" 68.2 mm	2.17" 55.2 mm	1.55" 39.4 mm	2.20" 55.8 mm	1.29" 32.8 mm	9/16-18 UNF	9/16-18 UNF	.88" 22.2 mm	.69" 17.5 mm
PS891005-8-8	2.96" 75.3 mm	2.37" 60.3 mm	1.86" 47.2 mm	2.72" 69.2 mm	1.73" 44.0 mm	3/4-16 UNF	3/4-16 UNF	1.12" 28.6 mm	.88" 22.2 mm
PS1291005-12-12	3.43" 87.2 mm	2.77" 70.4 mm	2.40" 61.0 mm	3.49" 88.5 mm	2.17" 55.2 mm	1-1/16-12 UN	1-1/16-12 UN	1.38" 35.0 mm	1.25" 31.8 mm
PS1691005-16-16	4.03" 102.3 mm	3.16" 80.3 mm	2.50" 63.4 mm	3.74" 94.9 mm	2.48" 63.0 mm	1-5/16-12 UN	1-5/16-12 UN	1.62" 41.3 mm	1.50" 38.1 mm

Female SAE Straight Thread - Female 37° Flare

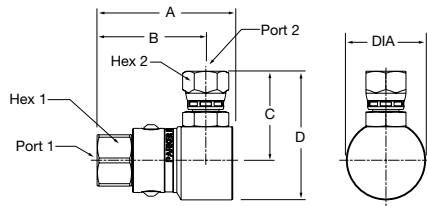

Part Number	A	B	C	D	Diameter	Port 1	Port 2	Wrench Flats 1	Wrench Flats 2
PS491006-4-4	2.42" 61.4 mm	2.01" 51.2 mm	1.47" 37.3 mm	2.07" 52.5 mm	1.20" 30.5 mm	7/16-20 UNF	7/16-20 UNF	.75" 19.0 mm	.56" 14.3 mm
PS691006-6-6	2.68" 68.2 mm	2.17" 55.2 mm	1.57" 39.9 mm	2.22" 56.3 mm	1.29" 32.8 mm	9/16-18 UNF	9/16-18 UNF	.88" 22.2 mm	.69" 17.5 mm
PS891006-8-8	2.96" 75.3 mm	2.37" 60.3 mm	1.91" 48.4 mm	2.77" 70.4 mm	1.73" 44.0 mm	3/4-16 UNF	3/4-16 UNF	1.12" 28.6 mm	.88" 22.2 mm
PS1291006-12-12	3.43" 87.2 mm	2.77" 70.4 mm	2.34" 59.4 mm	3.43" 87.0 mm	2.17" 55.2 mm	1-1/16-12 UN	1-1/16-12 UN	1.38" 35.0 mm	1.25" 31.8 mm
PS1691006-16-16	4.03" 102.3 mm	3.16" 80.3 mm	2.54" 64.6 mm	3.79" 96.2 mm	2.48" 63.0 mm	1-5/16-12 UN	1-5/16-12 UN	1.62" 41.3 mm	1.50" 38.1 mm

Female SAE Straight Thread - Female NPSM Pipe Swivel

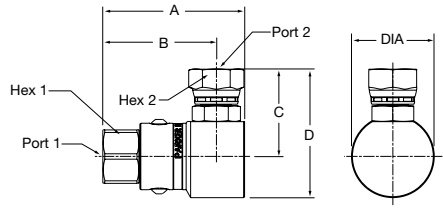

Part Number	A	B	C	D	Diameter	Port 1	Port 2	Wrench Flats 1	Wrench Flats 2
PS491007-4-4	2.42" 61.4 mm	2.01" 51.2 mm	1.48" 37.5 mm	2.08" 52.8 mm	1.20" 30.5 mm	7/16-20 UNF	1/4-18 NPSM	.75" 19.0 mm	.69" 17.4 mm
PS691007-6-6	2.68" 68.2 mm	2.17" 55.2 mm	1.51" 38.4 mm	2.16" 54.8 mm	1.29" 32.8 mm	9/16-18 UNF	3/8-18 NPSM	.88" 22.2 mm	.88" 22.2 mm
PS891007-8-8	2.96" 75.3 mm	2.37" 60.3 mm	1.86" 47.2 mm	2.72" 69.2 mm	1.73" 44.0 mm	3/4-16 UNF	1/2-14 NPSM	1.12" 28.6 mm	1.00" 25.4 mm
PS1291007-12-12	3.43" 87.2 mm	2.77" 70.4 mm	2.24" 56.9 mm	3.33" 84.5 mm	2.17" 55.2 mm	1-1/16-12 UN	3/4-14 NPSM	1.38" 35.0 mm	1.25" 31.8 mm
PS1691007-16-16	4.03" 102.3 mm	3.16" 80.3 mm	2.48" 63.1 mm	3.73" 94.6 mm	2.48" 63.0 mm	1-5/16-12 UN	1-11/2 NPSM	1.62" 41.3 mm	1.50" 38.1 mm

Female SAE Straight Thread - Female SAE Straight Thread

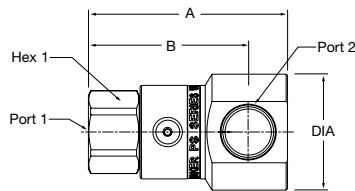

Part Number	A	B	Diameter	Port 1	Port 2	Wrench Flats 2
PS491010-4-4	2.42" 61.4 mm	2.01" 51.2 mm	1.20" 30.5 mm	7/16-20 UNF	7/16-20 UNF	.75" 19.0 mm
PS691010-6-6	2.68" 68.2 mm	2.17" 55.2 mm	1.29" 32.8 mm	9/16-18 UNF	9/16-18 UNF	.88" 22.2 mm
PS891010-8-8	2.96" 75.3 mm	2.37" 60.3 mm	1.73" 44.0 mm	3/4-16 UNF	3/4-16 UNF	1.12" 28.6 mm
PS1291010-12-12	3.43" 87.2 mm	2.77" 70.4 mm	2.17" 55.2 mm	1-1/16-12 UN	1-1/16-12 UN	1.38" 35.0 mm
PS1691010-16-16	4.03" 102.3 mm	3.16" 80.3 mm	2.48" 63.0 mm	1-5/16-12 UN	1-5/16-12 UN	1.62" 41.3 mm

3 Piece Design

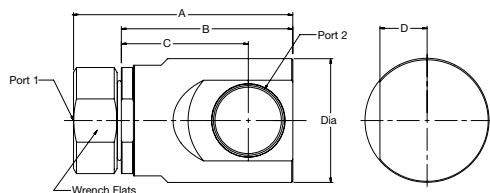

Part Number	A	B	C	D	Diameter	Port 1	Port 2	Wrench Flats
PS2491010-20-20	5.91" 150.2 mm	4.63" 117.5 mm	3.43" 87.0 mm	1.27" 32.3 mm	3.36" 85.2 mm	1 5/8-12 UN	1 5/8-12 UN	2.63" 66.7 mm
PS2491010-24-24	5.91" 150.2 mm	4.63" 117.5 mm	3.43" 87.0 mm	1.27" 32.3 mm	3.36" 85.2 mm	1 7/8-12 UN	1 7/8-12 UN	2.63" 66.7 mm
PS3291010-32-32	6.83" 179.8 mm	5.45" 138.4 mm	3.93" 99.7 mm	1.52" 38.5 mm	4.19" 106.4 mm	2 11-1/2 UN	2-1/2-12 UN	3.06" 77.6 mm

D Swivels



Performance Data

S Series Swivel (1/4", 3/8", 1/2", 3/4", 1")
 Test Fluid: Oil - 150 SUS vs. Pressure Drop

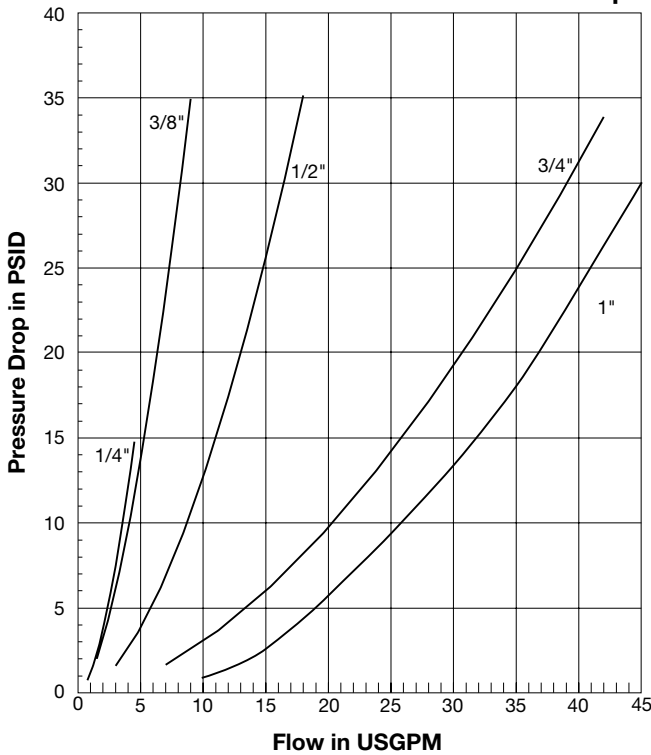

Introduction

The S Series Swivel product line complements the Quick Coupling Division's PS Series swivel line by offering a pressure balanced, compact forged body design. As a result of the pressure balanced design, the S Series Swivel does not experience a significant increase in torque as pressure rises. The housing body is forged to provide superior performance and durability in tough applications. This product is great for eliminating hose twist, torque and stress caused by the movement of the hydraulic components where side load to the swivel can be minimized.

Features

- 3000 psi working pressure rating for all sizes.
- Variety of seal options.
- Torque value does not significantly increase with pressure.
- Dust seals protect the swivel from damaging environmental contaminants.
- Field service kits are available for quick and reliable repairs.
- 360° swivel eliminates long radius bends, hose twist and stress that can cause premature hose failure.
- One piece forged housing eliminates a brazed 90° adapter connection.
- Case hardened for enhanced service life.
- Compact design to fit into tight areas.

S Series Swivel Specifications

Body Size	1/4	3/8	1/2	3/4	1
Maximum Rated Pressure (psi)	3000	3000	3000	3000	3000*
Temperature Range (standard seals)	-40° to 250° F				
Maximum RPM	10				

* 07 ports on 1" S Series maximum rated pressure is 2600 psi.

S Series Repair Kits

Repair Kits come complete with primary O-Rings, PTFE back-up rings, external and internal dust seals, retaining ring and instruction sheet.

Nitrile Seals		EP Seals		Fluorocarbon Seals	
Size	Kit Number	Size	Kit Number	Size	Kit Number
-4/-6	RK-4/6N	-4/-6	RK-4/6E	-4/-6	RK-4/6V
-8/-10	RK-8N	-8/-10	RK-8E	-8/-10	RK-8V
-12	RK-12N	-12	RK-12E	-12	RK-12V
-16	RK-16N	-16	RK-16E	-16	RK-16V

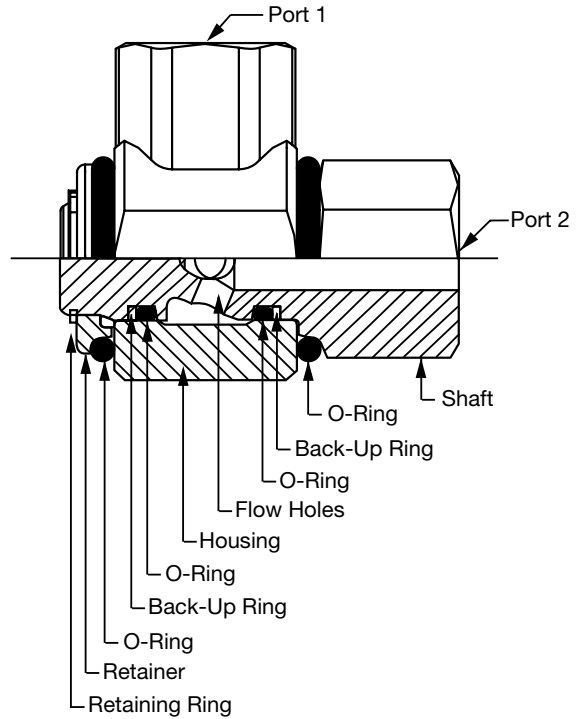

S Part Number:

S 21 02 V - 8 - 8 NI

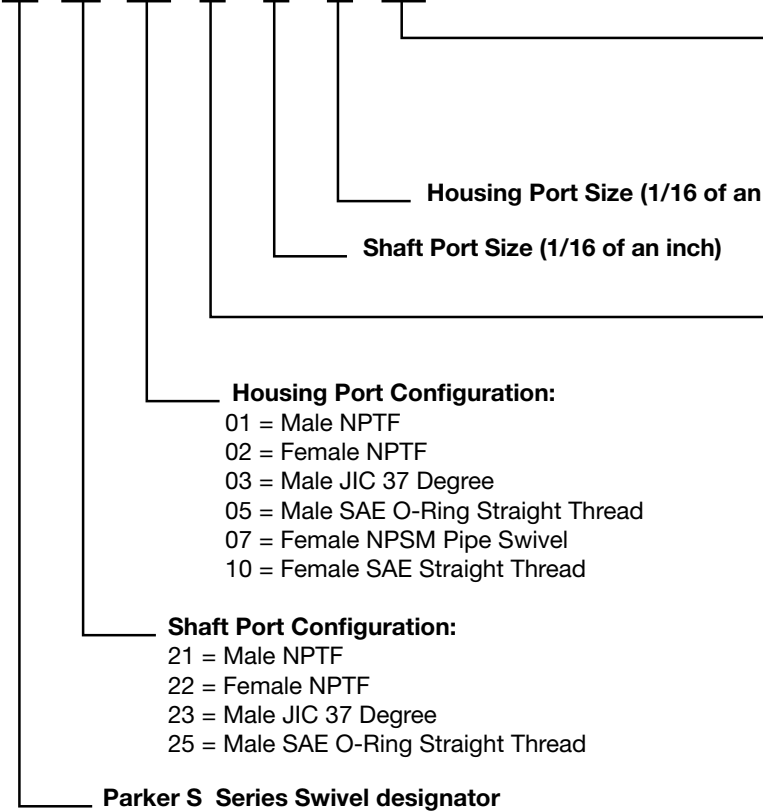

Material and Finish:
Blank = Carbon Steel (12L14)
w/Chromium-6 Free Plating
NI = Carbon Steel (12L14)*
Nickel Plating

Seal Code:
Blank = Nitrile (Standard)
E = Ethylene Propylene
V = Fluorocarbon

Housing Port Configuration:
01 = Male NPTF
02 = Female NPTF
03 = Male JIC 37 Degree
05 = Male SAE O-Ring Straight Thread
07 = Female NPSM Pipe Swivel
10 = Female SAE Straight Thread

Shaft Port Configuration:
21 = Male NPTF
22 = Female NPTF
23 = Male JIC 37 Degree
25 = Male SAE O-Ring Straight Thread

* Contact the Division for Price and Availability

Male Pipe - Male Pipe

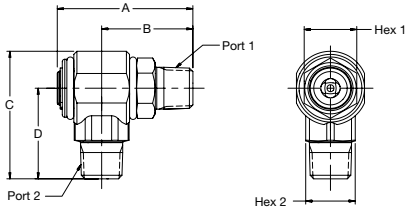

Part Number	A	B	C	D	Port 1	Port 2	Wrench Flats 1	Wrench Flats 2
S2101-4-4	2.31" 58.7 mm	1.51" 38.4 mm	2.19" 55.5 mm	1.50" 38.0 mm	1/4-18 NPTF	1/4-18 NPTF	.88" 22.2 mm	.88" 22.2 mm
S2101-6-6	2.31" 58.7 mm	1.51" 38.4 mm	2.19" 55.5 mm	1.50" 38.0 mm	3/8-18 NPTF	3/8-18 NPTF	.88" 22.2 mm	.88" 22.2 mm
S2101-8-8	2.74" 69.6 mm	1.84" 46.8 mm	2.59" 65.8 mm	1.84" 46.7 mm	1/2-14 NPTF	1/2-14 NPTF	1.06" 27.0 mm	1.00" 25.4 mm
S2101-12-12	3.35" 85.1 mm	2.12" 53.9 mm	3.00" 76.2 mm	2.11" 53.5 mm	3/4-14 NPTF	3/4-14 NPTF	1.38" 34.9 mm	1.38" 34.9 mm

Male Pipe - Female Pipe

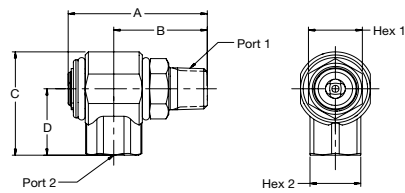

Part Number	A	B	C	D	Port 1	Port 2	Wrench Flats 1	Wrench Flats 2
S2102-4-4	2.31" 58.7 mm	1.51" 38.4 mm	1.78" 45.1 mm	1.09" 27.6 mm	1/4-18 NPTF	1/4-18 NPTF	.88" 22.2 mm	.88" 22.2 mm
S2102-6-6	2.31" 58.7 mm	1.51" 38.4 mm	1.78" 45.1 mm	1.09" 27.6 mm	3/8-18 NPTF	3/8-18 NPTF	.88" 22.2 mm	.88" 22.2 mm
S2102-8-8	2.74" 69.6 mm	1.84" 46.8 mm	2.10" 53.3 mm	1.35" 34.3 mm	1/2-14 NPTF	1/2-14 NPTF	1.06" 27.0 mm	1.00" 25.4 mm
S2102-12-12	3.35" 85.1 mm	2.12" 53.9 mm	2.39" 60.7 mm	1.50" 38.0 mm	3/4-14 NPTF	3/4-14 NPTF	1.38" 34.9 mm	1.38" 34.9 mm

Male Pipe - Male 37° Flare

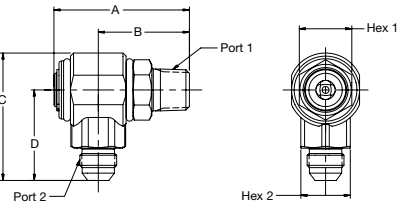

Part Number	A	B	C	D	Port 1	Port 2	Wrench Flats 1	Wrench Flats 2
S2103-4-4	2.31" 58.7 mm	1.51" 38.4 mm	2.19" 55.5 mm	1.50" 38.0 mm	1/4-18 NPTF	7/16-20 UNF	.88" 22.2 mm	.88" 22.2 mm
S2103-6-6	2.31" 58.7 mm	1.51" 38.4 mm	2.19" 55.5 mm	1.50" 38.0 mm	3/8-18 NPTF	9/16-18 UNF	.88" 22.2 mm	.88" 22.2 mm
S2103-8-8	2.74" 69.6 mm	1.84" 46.8 mm	2.59" 65.8 mm	1.84" 46.7 mm	1/2-14 NPTF	3/4-16 UNF	1.06" 27.0 mm	1.00" 25.4 mm
S2103-12-12	3.35" 85.1 mm	2.12" 53.9 mm	3.07" 77.9 mm	2.17" 55.2 mm	3/4-14 NPTF	1-1/16-12 UN	1.38" 34.9 mm	1.38" 34.9 mm
S2103-16-16	3.95" 100.33 mm	2.54" 64.5 mm	3.01" 76.5 mm	2.11" 53.6 mm	1-11 1/2 NPTF	1-5/16-12 UN	1.63" 41.4 mm	1.69" 42.9 mm

Male Pipe - Female NPSM Pipe Swivel

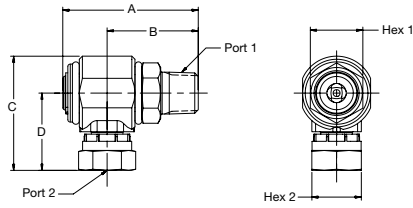

Part Number	A	B	C	D	Port 1	Port 2	Wrench Flats 1	Wrench Flats 2
S2107-4-4	2.31" 58.7 mm	1.51" 38.4 mm	2.05" 52.0 mm	1.36" 34.5 mm	1/4-18 NPTF	1/4-18 NPSM	.88" 22.2 mm	.69" 17.5 mm
S2107-6-6	2.31" 58.7 mm	1.51" 38.4 mm	2.07" 52.5 mm	1.38" 35.1 mm	3/8-18 NPTF	3/8-18 NPSM	.88" 22.2 mm	.88" 22.2 mm
S2107-8-8	2.74" 69.6 mm	1.84" 46.8 mm	2.32" 59.0 mm	1.57" 39.9 mm	1/2-14 NPTF	1/2-14 NPSM	1.06" 27.0 mm	1.00" 25.4 mm
S2107-12-12	3.35" 85.1 mm	2.12" 53.9 mm	2.74" 69.5 mm	1.85" 46.9 mm	3/4-14 NPTF	3/4-14 NPSM	1.38" 34.9 mm	1.25" 31.8 mm
S2107-16-16	3.95" 100.3 mm	2.54" 64.5 mm	3.14" 79.8 mm	2.23" 56.6 mm	1-11 1/2 NPTF	1-11 1/2 NPSM	1.63" 41.4 mm	1.69" 42.9 mm

Male Pipe - Female SAE Straight Thread

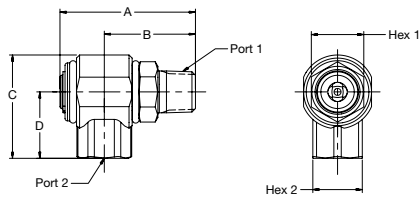

Part Number	A	B	C	D	Port 1	Port 2	Wrench Flats 1	Wrench Flats 2
S2110-6-6	2.31" 58.7 mm	1.51" 38.4 mm	1.78" 45.1 mm	1.09" 27.6 mm	3/8-18 NPTF	9/16-18 UNF	.88" 22.2 mm	.88" 22.2 mm
S2110-8-8	2.74" 69.6 mm	1.84" 46.8 mm	2.10" 53.3 mm	1.35" 34.3 mm	1/2-14 NPTF	3/4-16 UNF	1.06" 27.0 mm	1.00" 25.4 mm
S2110-12-12	3.35" 85.1 mm	2.12" 53.9 mm	2.54" 64.5 mm	1.65" 41.9 mm	3/4-14 NPTF	1-1/16-12 UN	1.38" 34.9 mm	1.38" 34.9 mm

Female Pipe - Male Pipe

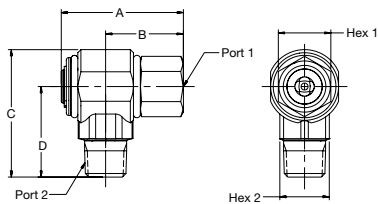

Part Number	A	B	C	D	Port 1	Port 2	Wrench Flats 1	Wrench Flats 2
S2201-4-4	2.19" 55.6 mm	1.39" 35.4 mm	2.19" 55.5 mm	1.50" 38.0 mm	1/4-18 NPTF	1/4-18 NPTF	.88" 22.2 mm	.88" 22.2 mm
S2201-6-6	2.19" 55.6 mm	1.39" 35.4 mm	2.19" 55.5 mm	1.50" 38.0 mm	3/8-18 NPTF	3/8-18 NPTF	.88" 22.2 mm	.88" 22.2 mm
S2201-8-8	2.47" 62.7 mm	1.57" 40.0 mm	2.59" 65.8 mm	1.84" 46.7 mm	1/2-14 NPTF	1/2-14 NPTF	1.06" 27.0 mm	1.00" 25.4 mm
S2201-12-12	3.15" 80.0 mm	1.92" 48.8 mm	3.00" 76.2 mm	2.11" 53.5 mm	3/4-14 NPTF	3/4-14 NPTF	1.38" 34.9 mm	1.38" 34.9 mm

Female Pipe - Female Pipe

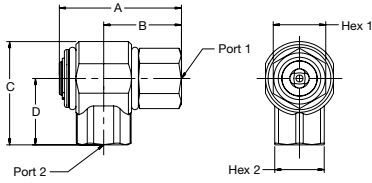

Part Number	A	B	C	D	Port 1	Port 2	Wrench Flats 1	Wrench Flats 2
S2202-4-4	2.19" 55.6 mm	1.39" 35.4 mm	1.78" 45.1 mm	1.09" 27.6 mm	1/4-18 NPTF	1/4-18 NPTF	.88" 22.2 mm	.88" 22.2 mm
S2202-6-6	2.19" 55.6 mm	1.39" 35.4 mm	1.78" 45.1 mm	1.09" 27.6 mm	3/8-18 NPTF	3/8-18 NPTF	.88" 22.2 mm	.88" 22.2 mm
S2202-8-8	2.47" 62.7 mm	1.57" 40.0 mm	2.10" 53.3 mm	1.35" 34.3 mm	1/2-14 NPTF	1/2-14 NPTF	1.06" 27.0 mm	1.00" 25.4 mm
S2202-12-12	3.15" 80.0 mm	1.92" 48.8 mm	2.39" 60.7 mm	1.50" 38.0 mm	3/4-14 NPTF	3/4-14 NPTF	1.38" 34.9 mm	1.38" 34.9 mm

Female Pipe - Male 37° Flare

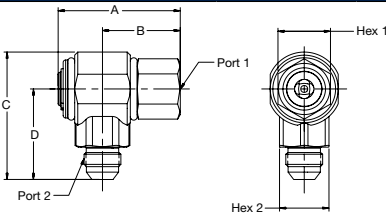

Part Number	A	B	C	D	Port 1	Port 2	Wrench Flats 1	Wrench Flats 2
S2203-4-4	2.19" 55.6 mm	1.39" 35.4 mm	2.19" 55.5 mm	1.50" 38.0 mm	1/4-18 NPTF	7/16-20 UNF	.88" 22.2 mm	.88" 22.2 mm
S2203-6-6	2.19" 55.6 mm	1.39" 35.4 mm	2.19" 55.5 mm	1.50" 38.0 mm	3/8-18 NPTF	9/16-18 UNF	.88" 22.2 mm	.88" 22.2 mm
S2203-8-8	2.47" 62.7 mm	1.57" 40.0 mm	2.59" 65.8 mm	1.84" 46.7 mm	1/2-14 NPTF	3/4-16 UNF	1.06" 27.0 mm	1.00" 25.4 mm
S2203-12-12	3.15" 80.0 mm	1.92" 48.8 mm	3.07" 77.9 mm	2.17" 55.2 mm	3/4-14 NPTF	1-1/16-12 UN	1.38" 34.9 mm	1.38" 34.9 mm
S2203-16-16	3.55" 90.2 mm	2.13" 54.1 mm	3.01" 76.5 mm	2.11" 53.6 mm	1-11/2 NPTF	1-5/16-12 UN	1.63" 41.4 mm	1.69" 42.9 mm

Female Pipe - Female SAE Straight Thread

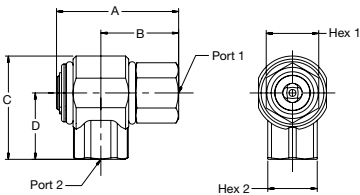

Part Number	A	B	C	D	Port 1	Port 2	Wrench Flats 1	Wrench Flats 2
S2210-6-6	2.19" 55.6 mm	1.39" 35.4 mm	1.78" 45.1 mm	1.09" 27.6 mm	3/8-18 NPTF	9/16-18 UNF	.88" 22.2 mm	.88" 22.2 mm
S2210-8-8	2.47" 62.7 mm	1.57" 40.0 mm	2.10" 53.3 mm	1.35" 34.3 mm	1/2-14 NPTF	3/4-16 UNF	1.06" 27.0 mm	1.00" 25.4 mm
S2210-12-12	3.15" 80.0 mm	1.92" 48.8 mm	2.54" 64.5 mm	1.65" 41.9 mm	3/4-14 NPTF	1-1/16-12 UN	1.38" 34.9 mm	1.38" 34.9 mm

Female Pipe - Female NPSM Pipe Swivel

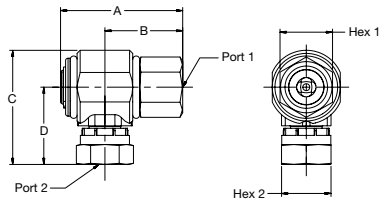

Part Number	A	B	C	D	Port 1	Port 2	Wrench Flats 1	Wrench Flats 2
S2207-4-4	2.19" 55.6 mm	1.39" 35.4 mm	2.05" 52.0 mm	1.36" 34.5 mm	1/4-18 NPTF	1/4-18 NPSM	.88" 22.2 mm	.69" 17.5 mm
S2207-6-6	2.19" 55.6 mm	1.39" 35.4 mm	2.07" 52.5 mm	1.38" 35.1 mm	3/8-18 NPTF	3/8-18 NPSM	.88" 22.2 mm	.88" 22.2 mm
S2207-8-8	2.47" 62.7 mm	1.57" 40.0 mm	2.32" 59.0 mm	1.57" 39.9 mm	1/2-14 NPTF	1/2-14 NPSM	1.06" 27.0 mm	1.00" 25.4 mm
S2207-12-12	3.15" 80.0 mm	1.92" 48.8 mm	2.74" 69.5 mm	1.85" 46.9 mm	3/4-14 NPTF	3/4-14 NPSM	1.38" 34.9 mm	1.25" 31.8 mm
S2207-16-16	3.55" 90.2 mm	2.13" 54.1 mm	3.14" 79.8 mm	2.23" 56.6 mm	1-11 1/2 NPTF	1-11 1/2 NPSM	1.63" 41.4 mm	1.69" 42.9 mm

Male 37° Flare - Male Pipe

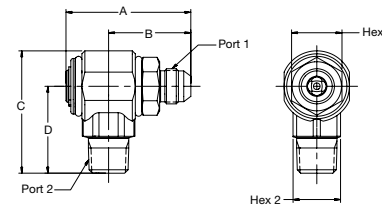

Part Number	A	B	C	D	Port 1	Port 2	Wrench Flats 1	Wrench Flats 2
S2301-4-4	2.41" 61.2 mm	1.61" 40.9 mm	2.19" 55.5 mm	1.50" 38.0 mm	7/16-20 UNF	1/4-18 NPTF	.88" 22.2 mm	.88" 22.2 mm
S2301-6-6	2.41" 61.2 mm	1.61" 40.9 mm	2.19" 55.5 mm	1.50" 38.0 mm	9/16-18 UNF	3/8-18 NPTF	.88" 22.2 mm	.88" 22.2 mm
S2301-8-8	2.63" 66.8 mm	1.73" 44.0 mm	2.59" 65.8 mm	1.84" 46.7 mm	3/4-16 UNF	1/2-14 NPTF	1.06" 27.0 mm	1.00" 25.4 mm
S2301-12-12	3.33" 84.6 mm	2.10" 53.4 mm	3.00" 76.2 mm	2.11" 53.5 mm	1-1/16-12 UN	3/4-14 NPTF	1.38" 34.9 mm	1.38" 34.9 mm

Male 37° Flare - Female Pipe

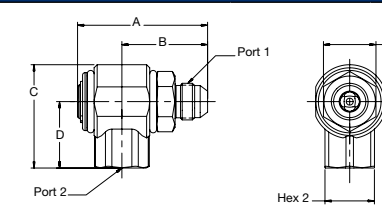

Part Number	A	B	C	D	Port 1	Port 2	Wrench Flats 1	Wrench Flats 2
S2302-4-4	2.41" 61.2 mm	1.61" 40.9 mm	1.78" 45.1 mm	1.09" 27.6 mm	7/16-20 UNF	1/4-18 NPTF	.88" 22.2 mm	.88" 22.2 mm
S2302-6-6	2.41" 61.2 mm	1.61" 40.9 mm	1.78" 45.1 mm	1.09" 27.6 mm	9/16-18 UNF	3/8-18 NPTF	.88" 22.2 mm	.88" 22.2 mm
S2302-8-8	2.63" 66.8 mm	1.73" 44.0 mm	2.10" 53.3 mm	1.35" 34.3 mm	3/4-16 UNF	1/2-14 NPTF	1.06" 27.0 mm	1.00" 25.4 mm
S2302-12-12	3.33" 84.6 mm	2.10" 53.4 mm	2.39" 60.7 mm	1.50" 38.0 mm	1-1/16-12 UN	3/4-14 NPTF	1.38" 34.9 mm	1.38" 34.9 mm



Male 37° Flare - Male 37° Flare

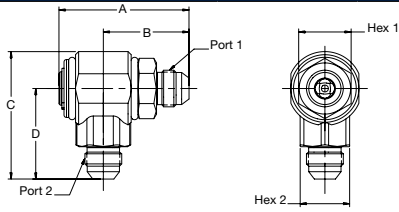

Part Number	A	B	C	D	Port 1	Port 2	Wrench Flats 1	Wrench Flats 2
S2303-4-4	2.41" 61.2 mm	1.61" 40.9 mm	2.19" 55.5 mm	1.50" 38.0 mm	7/16-20 UNF	7/16-20 UNF	.88" 22.2 mm	.88" 22.2 mm
S2303-6-6	2.41" 61.2 mm	1.61" 40.9 mm	2.19" 55.5 mm	1.50" 38.0 mm	9/16-18 UNF	9/16-18 UNF	.88" 22.2 mm	.88" 22.2 mm
S2303-8-8	2.63" 66.8 mm	1.73" 44.0 mm	2.59" 65.8 mm	1.84" 46.7 mm	3/4-16 UNF	3/4-16 UNF	1.06" 27.0 mm	1.00" 25.4 mm
S2303-10-10	2.63" 66.8 mm	1.73" 44.0 mm	2.59" 65.8 mm	1.84" 46.7 mm	7/8-14 UNF	7/8-14 UNF	1.06" 27.0 mm	1.00" 25.4 mm
S2303-12-12	3.33" 84.6 mm	2.10" 53.4 mm	3.07" 77.9 mm	2.17" 55.2 mm	1-1/16-12 UN	1-1/16-12 UN	1.38" 34.9 mm	1.38" 34.9 mm
S2303-16-16	4.05" 102.9 mm	2.64" 67.1 mm	3.01" 76.5 mm	2.11" 53.6 mm	1-5/16-12 UN	1-5/16-12 UN	1.63" 41.4 mm	1.69" 42.9 mm

Male 37° Flare - Female NPSM Pipe Swivel

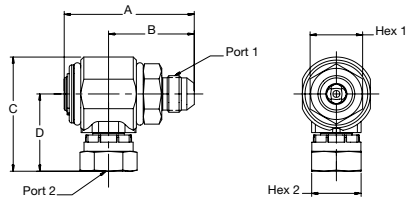

Part Number	A	B	C	D	Port 1	Port 2	Wrench Flats 1	Wrench Flats 2
S2307-4-4	2.41" 61.2 mm	1.61" 40.9 mm	2.05" 52.0 mm	1.36" 34.5 mm	7/16-20 UNF	1/4-18 NPSM	.88" 22.2 mm	.69" 17.5 mm
S2307-6-6	2.41" 61.2 mm	1.61" 40.9 mm	2.07" 52.5 mm	1.38" 35.1 mm	9/16-18 UNF	3/8-18 NPSM	.88" 22.2 mm	.88" 22.2 mm
S2307-8-8	2.63" 66.8 mm	1.73" 44.0 mm	2.32" 59.0 mm	1.57" 39.9 mm	3/4-16 UNF	1/2-14 NPSM	1.06" 27.0 mm	1.00" 25.4 mm
S2307-12-12	3.33" 84.6 mm	2.10" 53.4 mm	2.74" 69.5 mm	1.85" 46.9 mm	1-1/16-12 UN	3/4-14 NPSM	1.38" 34.9 mm	1.25" 31.8 mm

Male 37° Flare - Female SAE Straight Thread

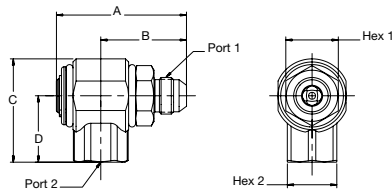

Part Number	A	B	C	D	Port 1	Port 2	Wrench Flats 1	Wrench Flats 2
S2310-6-6	2.41" 61.2 mm	1.61" 40.9 mm	1.78" 45.1 mm	1.09" 27.6 mm	9/16-18 UNF	9/16-18 UNF	.88" 22.2 mm	.88" 22.2 mm
S2310-8-8	2.63" 66.8 mm	1.73" 44.0 mm	2.10" 53.3 mm	1.35" 34.3 mm	3/4-16 UNF	3/4-16 UNF	1.06" 27.0 mm	1.00" 25.4 mm
S2310-12-12	3.33" 84.6 mm	2.10" 53.4 mm	2.54" 64.5 mm	1.65" 41.9 mm	1-1/16-12 UN	1-1/16-12 UN	1.38" 34.9 mm	1.38" 34.9 mm

Male SAE O-Ring Straight Thread - Male Pipe

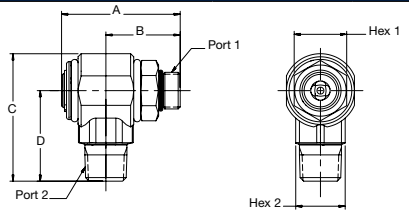

Part Number	A	B	C	D	Port 1	Port 2	Wrench Flats 1	Wrench Flats 2
S2501-6-6	2.13" 54.1 mm	1.33" 33.8 mm	2.19" 55.5 mm	1.50" 38.0 mm	9/16-18 UNF	3/8-18 NPTF	.88" 22.2 mm	.88" 22.2 mm
S2501-8-8	2.40" 61.0 mm	1.50" 38.2 mm	2.59" 65.8 mm	1.84" 46.7 mm	3/4-16 UNF	1/2-14 NPTF	1.06" 27.0 mm	1.00" 25.4 mm
S2501-12-12	3.40" 86.4 mm	2.17" 55.2 mm	3.00" 76.2 mm	2.11" 53.5 mm	1-1/16-12 UN	3/4-14 NPTF	1.38" 34.9 mm	1.38" 34.9 mm

Male SAE O-Ring Straight Thread - Female Pipe

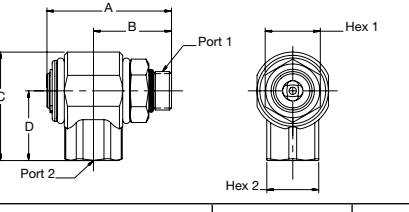

Part Number	A	B	C	D	Port 1	Port 2	Wrench Flats 1	Wrench Flats 2
S2502-6-6	2.13" 54.1 mm	1.33" 33.8 mm	1.78" 45.1 mm	1.09" 27.6 mm	9/16-18 UNF	3/8-18 NPTF	.88" 22.2 mm	.88" 22.2 mm
S2502-8-8	2.40" 61.0 mm	1.50" 38.2 mm	2.10" 53.3 mm	1.35" 34.3 mm	3/4-16 UNF	1/2-14 NPTF	1.06" 27.0 mm	1.00" 25.4 mm
S2502-12-12	3.40" 86.4 mm	2.17" 55.2 mm	2.39" 60.7 mm	1.50" 38.0 mm	1-1/16-12 UN	3/4-14 NPTF	1.38" 34.9 mm	1.38" 34.9 mm

Male SAE O-Ring Straight Thread - Male 37° Flare

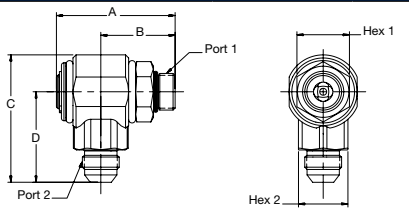

Part Number	A	B	C	D	Port 1	Port 2	Wrench Flats 1	Wrench Flats 2
S2503-6-6	2.13" 54.1 mm	1.33" 33.8 mm	2.19" 55.5 mm	1.50" 38.0 mm	9/16-18 UNF	9/16-18 UNF	.88" 22.2 mm	.88" 22.2 mm
S2503-8-8	2.40" 61.0 mm	1.50" 38.2 mm	2.59" 65.8 mm	1.84" 46.7 mm	3/4-16 UNF	3/4-16 UNF	1.06" 27.0 mm	1.00" 25.4 mm
S2503-10-10	2.54" 64.5 mm	1.64" 41.7 mm	2.59" 65.8 mm	1.84" 46.7 mm	7/8-14 UNF	7/8-14 UNF	1.06" 27.0 mm	1.00" 25.4 mm
S2503-12-12	3.40" 86.4 mm	2.17" 55.2 mm	3.07" 77.9 mm	2.17" 55.2 mm	1-1/16-12 UN	1-1/16-12 UN	1.38" 34.9 mm	1.38" 34.9 mm
S2503-16-16	3.75" 95.3 mm	2.33" 59.2 mm	3.01" 76.5 mm	2.11" 53.6 mm	1-5/16-12 UN	1-5/16-12 UN	1.63" 41.4 mm	1.69" 42.9 mm

Male SAE O-Ring Straight Thread - Female NPSM Pipe Swivel

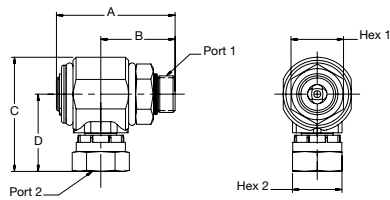

Part Number	A	B	C	D	Port 1	Port 2	Wrench Flats 1	Wrench Flats 2
S2507-6-6	2.13" 54.1 mm	1.33" 33.8 mm	2.07" 52.5 mm	1.38" 35.1 mm	9/16-18 UNF	3/8-18 NPSM	.88" 22.2 mm	.88" 22.2 mm
S2507-8-8	2.40" 61.0 mm	1.50" 38.2 mm	2.32" 59.0 mm	1.57" 39.9 mm	3/4-16 UNF	1/2-14 NPSM	1.06" 27.0 mm	1.00" 25.4 mm
S2507-12-12	3.75" 86.4 mm	2.17" 55.2 mm	2.74" 69.5 mm	1.85" 46.9 mm	1-1/16-12 UN	3/4-14 NPSM	1.38" 34.9 mm	1.25" 31.8 mm
S2507-16-16	3.75" 95.3 mm	2.33" 59.2 mm	3.14" 79.8 mm	2.23" 56.6 mm	1-5/16-12 UN	1-11 1/2 NPSM	1.63" 41.4 mm	1.69" 42.9 mm

Male SAE O-Ring Straight Thread - Female SAE Straight Thread

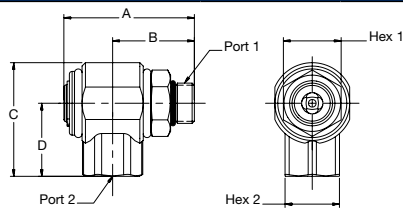

Part Number	A	B	C	D	Port 1	Port 2	Wrench Flats 1	Wrench Flats 2
S2510-6-6	2.13" 54.1 mm	1.33" 33.8 mm	1.78" 45.1 mm	1.09" 27.6 mm	9/16-18 UNF	9/16-18 UNF	.88" 22.2 mm	.88" 22.2 mm
S2510-8-8	2.40" 61.0 mm	1.50" 38.2 mm	2.10" 53.3 mm	1.35" 34.3 mm	3/4-16 UNF	3/4-16 UNF	1.06" 27.0 mm	1.00" 25.4 mm
S2510-12-12	3.40" 86.4 mm	2.17" 55.2 mm	2.54" 64.5 mm	1.65" 41.9 mm	1-1/16-12 UN	1-1/16-12 UN	1.38" 34.9 mm	1.38" 34.9 mm



aerospace
climate control
electromechanical
filtration
fluid & gas handling
hydraulics
pneumatics
process control
sealing & shielding



Quick Coupling Products

Quick Couplings, Swivels, Valves,
Diagnostic Equipment
Catalog 3800 USA | February 2014



ENGINEERING YOUR SUCCESS.

Quick Coupling Division Locations



Minneapolis, MN



Grantsburg, WI



Chetek, WI



Union City, PA

WARNING

FAILURE OR IMPROPER SELECTION OR IMPROPER USE OF THE PRODUCTS DESCRIBED HEREIN OR RELATED ITEMS CAN CAUSE DEATH, PERSONAL INJURY AND PROPERTY DAMAGE.

- This document and other information from Parker-Hannifin Corporation, its subsidiaries and authorized distributors provide product or system options for further investigation by users having technical expertise.
- The user, through its own analysis and testing, is solely responsible for making the final selection of the system and components and assuring that all performance, endurance, maintenance, safety and warning requirements of the application are met. The user must analyze all aspects of the application, follow applicable industry standards, and follow the information concerning the product in the current product catalog and in any other materials provided from Parker or its subsidiaries or authorized distributors.
- To the extent that Parker or its subsidiaries or authorized distributors provide component or system options based upon data or specifications provided by the user, the user is responsible for determining that such data and specifications are suitable and sufficient for all applications and reasonably foreseeable uses of the components or systems.

Offer of Sale

The items described in this document are hereby offered for sale by Parker Hannifin Corporation, its subsidiaries or its authorized distributors. This offer and its acceptance are governed by the provisions stated in the "Offer of Sale."

Table of Contents

Pneumatic Quick Couplings.....Section A

Hydraulic Quick Couplings.....Section B

Thermoplastic Couplings.....Section C

Swivels.....Section D

Valves.....Section E

Diagnostic Products.....Section F

Appendices:

Fluid Compatibility Chart.....I

Safety Guide.....VI

Offer of Sale.....IX

Glossary of Terms.....X



Valves

Multiple Hydraulic System Applications

Parker Check Valves are unidirectional flow control devices used primarily in hydraulic systems to eliminate potential damage caused by fluid back pressure. Offered in many configurations, Parker can satisfy most hydraulic system applications. Parker's in-line style check valves are available in a variety of sizes, pressure ratings, flow capacities and crack pressures.

H1, HM1 and PV Series Pressure / Vacuum Relief Valves are used to create and maintain a positive pressure in hydraulic tanks and reservoirs. These pressurized reservoir valves provide the following benefits:

- Prevents pump cavitation by assuring a positive supply of oil at the pump inlet
- Minimizes the tank breathing of outside, moist, contaminated air
- Filters all incoming air

As oil is drawn from the reservoir and pumped to the circuit, a vacuum is created in the reservoir. The vacuum relief valve opens to allow filtered air to enter. As oil is pumped back into the reservoir, air pressure builds. Additionally, as the oil heats, the pressure inside the reservoir increases. When the pressure exceeds the relief valve setting, the excess pressure is vented to atmosphere. Normally, the pressure will fluctuate between zero and the pressure relief setting without opening either valve. This can significantly reduce the breathing of outside air and minimize the chance for moisture and contamination to enter.

TH Series Thermal Bypass Valves ensure efficient equipment operation at any temperature. These valves are ideally suited for hydrostatic drive circuits which require fast warm-up, controlled fluid temperatures and low return line back pressure. When installed in a return line of a hydraulic circuit that utilizes an oil cooler, this valve will modulate fluid temperature by either shifting return line flow through the cooler, or bypassing directly to the reservoir. An integral pressure relief function automatically releases excess pressure to the reservoir if the cooler becomes restricted and the inlet pressure becomes excessive.



Table of Contents

Introduction	E-1
Check Valves	
Selection Guide & General	
Technical Information	E-3
CV Series	E-9
Ordering Information	E-11
DC Series	E-12
Ordering Information	E-13
DT Series	E-4
Ordering Information	E-8
CPIFF Series (soft seat)	E-14
S6C Series (soft seat)	E-15
3C Series (soft seat)	E-15
2600 Series (swing type)	E-17
Pressure/Vacuum Relief Valves	
H1 & HM1 Series	E-18
Ordering Information	E-18
PV Series	E-19
Ordering Information	E-19
Thermal Bypass Valves	
TH Series	E-20
Ordering Information	E-21



Parker's Check Valves have several unique features that insure years of trouble-free operation.

Selection Guide					
Series	Body Size	Material	Type	Rated Pressure (psi)	Crack Pressure Range (psi)
CV Series	1/4 - 1"	Steel	Metal to Metal Seal	3000	5-130
DT Series	1/4 - 1 1/4"			2500-5000	5-200
DC Series	1/4 - 2"			3000	5-100
CPIFF Series	1/4 - 1"	Steel	Soft Seat	5000	5-65
3C Series	1 1/4 - 2"	Steel		3000	5-65
S6C Series	1/4 - 1"	316 Stainless Steel		6000	5-65

Crack Pressure

Crack pressure refers to the amount of fluid pressure in the free flow direction required to move the poppet off the seat. The normal crack pressure setting is 5 PSI; however, other crack pressures are available to allow the check valve to perform special circuit functions, or operate under unique conditions.

Check valves are not field repairable or adjustable. Crack pressure settings are made at the factory only.

Applications

Typical hydraulic circuit, the check valve is used to protect the pump by preventing pressure from returning to the outlet port of the pump.

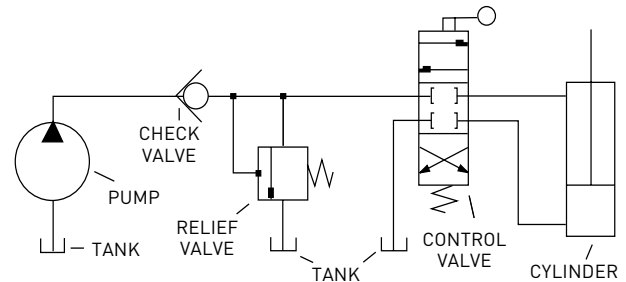
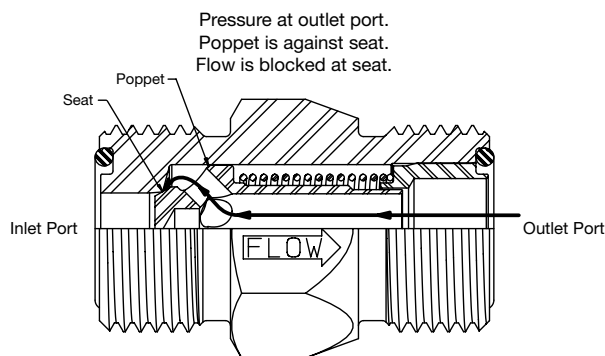
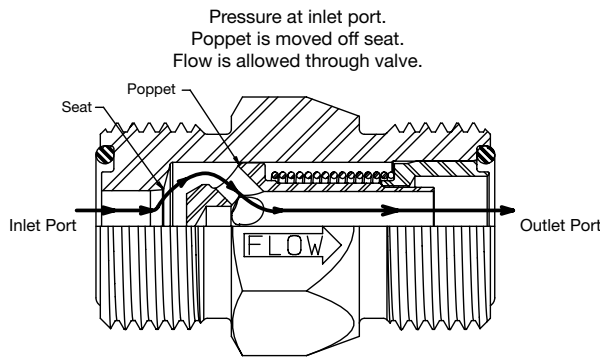

The graphic symbol for a check-valve is:

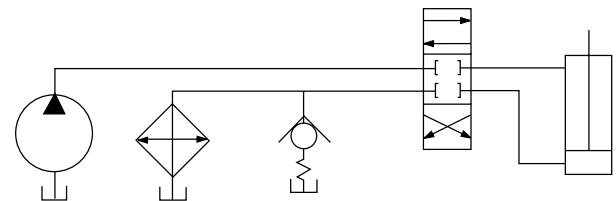

Oil cooler bypass circuit. If return line pressure becomes excessive due to resistance through oil cooler (such as startup in cold weather). Check valve opens and allows oil to bypass the cooler and flow to the tank.

E Valves



Parker DT Series Check Valves Offer the Features of a Compact Body Size, and up to 5000 psi Maximum Operating Pressure.

The DT Series check valves utilize the dependable, internal design features found in Parker check valves, but with the added benefit and convenience of compact design. Sizes are available from 1/4" to 1-1/4" with six different Fitting Styles. The DT Series expands Parker's high quality product line of versatile and efficient check valves.

Features

- Compact Design. Easy to plumb into tight circuits.
- All steel construction. No internal gaskets or seals to wear out.
- One-piece body eliminates threads and seals that may be potential leakage points.
- Smooth flow stream. Poppet spring is isolated from flow stream.
- Variety of end fittings.
- Optional crack pressures available from 1 to 200 PSI.
- Chromium-6 Free plated exterior finish.
- Nitrile O-Ring included on MO and MS fittings.
- Captive O-Ring Groove is standard on MS end fittings.

Specifications

The DT Series check valves have a Maximum Operating Pressure of 2500-5000 PSI. Standard crack pressures are 1, 5, and 65 PSI depending on the port size and configuration. Other crack pressures up to 200 PSI in 5 PSI increments are available upon request.

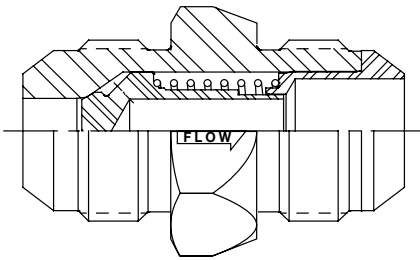

DT-MFMF

Male Flare 37° JIC Inlet to Male Flare 37° JIC Outlet

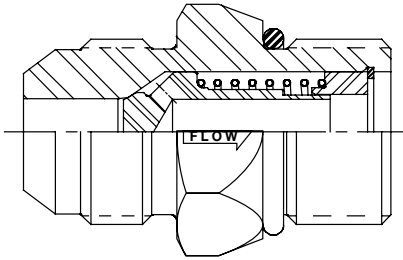

DT-MFMO

Male Flare 37° JIC Inlet to Male O-Ring Boss Outlet

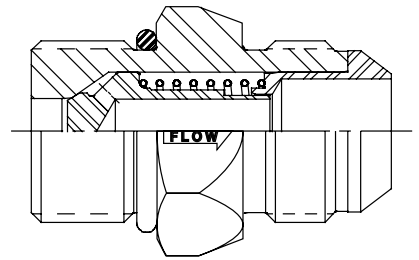

DT-MOMF

Male O-Ring Boss Inlet to Male Flare 37° JIC Outlet

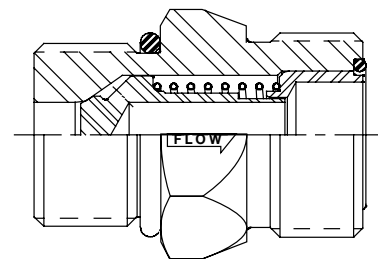

DT-MOMS

Male O-Ring Boss Inlet to Male Seal-Lok® Outlet

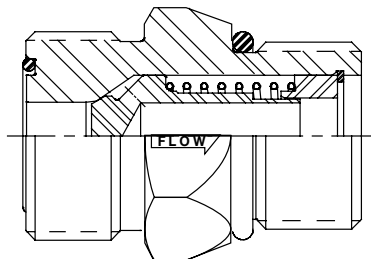

DT-MSMO

Male Seal-Lok® Inlet to Male O-Ring Boss Outlet

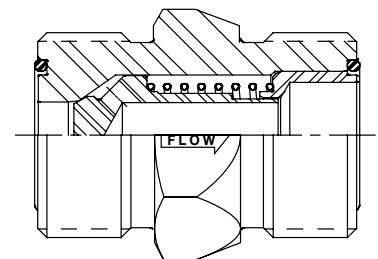

DT-MSMS

Male Seal-Lok® Inlet to Male Seal-Lok® Outlet

DT-MFMF Male Flare 37° JIC Inlet to Male Flare 37° JIC Outlet

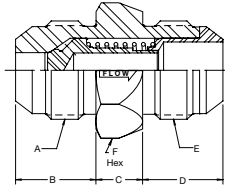

Valve Size	Part Number	Inlet Port Thread	Dimensions (in.)				Outlet Port Thread	Wrench Flats	** Std Crack Pressure (psi)
		A	B	C	D	E	F		
3/8	DT-370-MFMF-**	9/16-18 UNF	.56	.44	.56	9/16-18 UNF	.75	1, 5, 65	
1/2	DT-500-MFMF-**	3/4-16 UNF	.66	.50	.66	3/4-16 UNF	.88	5, 65	
5/8	DT-620-MFMF-**	7/8-14 UNF	.76	.50	.76	7/8-14 UNF	1.06	5	
3/4	DT-750-MFMF-**	1-1/16 - 12 UN	.86	.50	.86	1-1/16-12 UN	1.25	1, 5, 65	
1	DT-1000-MFMF-**	1-5/16 - 12 UN	.91	.62	.91	1-5/16-12 UN	1.50	5, 65	
1-1/4	DT-1250-MFMF-**	1-5/8 - 12 UN	.96	1.06	.96	1-5/8-12 UN	1.88	1, 5	

DT-MFMO Male Flare 37° JIC Inlet to Male O-Ring Boss Outlet

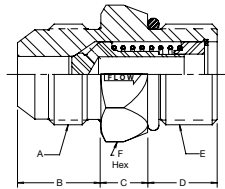

Valve Size	Part Number	Inlet Port Thread	Dimensions (in.)				Outlet Port Thread	Wrench Flats	** Std Crack Pressure (psi)
		A	B	C	D	E	F		
3/8	DT-370-MFMO-**	9/16-18 UNF	.56	.44	.47	9/16-18 UNF	.75	1, 5, 65	
1/2	DT-500-MFMO-**	3/4-16 UNF	.66	.50	.55	3/4-16 UNF	.88	5, 65	
5/8	DT-620-MFMO-**	7/8-14 UNF	.76	.50	.63	7/8-14 UNF	1.06	5	
3/4	DT-750-MFMO-**	1-1/16 - 12 UN	.86	.50	.73	1-1/16 - 12 UN	1.25	1, 5, 65	
1	DT-1000-MFMO-**	1-5/16 - 12 UN	.91	.62	.73	1-5/16 - 12 UN	1.50	5, 65	
1-1/4	DT-1250-MFMO-**	1-5/8 - 12 UN	.96	1.06	.73	1-5/8 - 12 UN	1.88	1, 5	

DT-MOMF Male O-Ring Boss Inlet to Male Flare 37° JIC Outlet

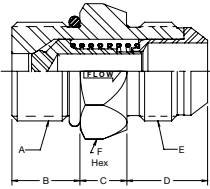

Valve Size	Part Number	Inlet Port Thread	Dimensions (in.)				Outlet Port Thread	Wrench Flats	** Std Crack Pressure (psi)
		A	B	C	D	E	F		
1/4	DT-250-MOMF-**	7/16-20 UNF	.43	.44	.55	7/16-20 UNF	.62	5	
3/8	DT-370-MOMF-**	9/16-18 UNF	.47	.44	.56	9/16-18 UNF	.75	1, 5, 65	
1/2	DT-500-MOMF-**	3/4-16 UNF	.55	.50	.66	3/4-16 UNF	.88	5, 65	
5/8	DT-620-MOMF-**	7/8-14 UNF	.63	.50	.76	7/8-14 UNF	1.06	5	
3/4	DT-750-MOMF-**	1-1/16 - 12 UN	.73	.50	.86	1-1/16 - 12 UN	1.25	1, 5, 65	
1	DT-1000-MOMF-**	1-5/16 - 12 UN	.73	.62	.91	1-5/16 - 12 UN	1.50	5, 65	
1-1/4	DT-1250-MOMF-**	1-5/8 - 12 UN	.73	1.06	.96	1-5/8 - 12 UN	1.88	1, 5	

DT-MOMS Male O-Ring Boss Inlet to Male Seal-Lok® Outlet

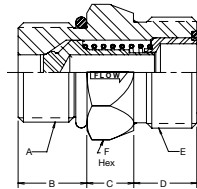

Valve Size	Part Number	Inlet Port Thread	Dimensions (in.)				Outlet Port Thread	Wrench Flats	** Std Crack Pressure (psi)
		A	B	C	D	E	F		
1/4	DT-250-MOMS-**	7/16-20 UNF	.43	.45	.39	9/16-18 UNF	.62	5	
3/8	DT-370-MOMS-**	9/16-18 UNF	.47	.44	.44	11/16-16 UN	.75	1, 5, 65	
1/2	DT-500-MOMS-**	3/4-16 UNF	.55	.50	.51	13/16-16 UN	.88	5, 65	
5/8	DT-620-MOMS-**	7/8-14 UNF	.63	.50	.62	1-14 UNS	1.06	5	
3/4	DT-750-MOMS-**	1-1/16 - 12 UN	.73	.50	.68	1-3/16 - 12 UN	1.25	1, 5, 65	
1	DT-1000-MOMS-**	1-5/16 - 12 UN	.73	.62	.70	1-7/16 - 12 UN	1.50	5, 65	
1-1/4	DT-1250-MOMS-**	1-5/8 - 12 UN	.73	1.06	.70	1-11/16 - 12 UN	1.88	1, 5	

E Valves

DT-MSMO Male Seal-Lok® Inlet to Male O-Ring Boss Outlet

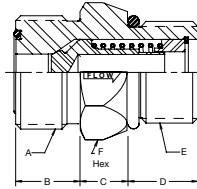

Valve Size	Part Number	Inlet Port Thread	Dimensions (in.)			Outlet Port Thread	Wrench Flats	** Std Crack Pressure (psi)
			A	B	C			
3/8	DT-370-MSMO-**	11/16-16 UN	.44	.44	.47	9/16-18 UNF	.75	1, 5, 65
1/2	DT-500-MSMO-**	13/16-16 UN	.51	.50	.55	3/4-16 UNF	.88	5, 65
5/8	DT-620-MSMO-**	1-14 UNS	.62	.49	.63	7/8-14 UNF	1.06	5
3/4	DT-750-MSMO-**	1-3/16 - 12 UN	.68	.50	.73	1-1/16 - 12 UN	1.25	1, 5, 65
1	DT-1000-MSMO-**	1-7/16 - 12 UN	.70	.62	.73	1-5/16 - 12 UN	1.50	5, 65
1-1/4	DT-1250-MSMO-**	1-11/16 - 12 UN	.70	1.06	.73	1-5/8 - 12 UN	1.88	1, 5

DT-MSMS Male Seal-Lok® Inlet to Male Seal-Lok® Outlet

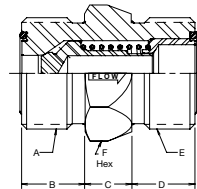

Valve Size	Part Number	Inlet Port Thread	Dimensions (in.)			Outlet Port Thread	Wrench Flats	** Std Crack Pressure (psi)
			A	B	C			
3/8	DT-370-MSMS-**	11/16-16 UN	.44	.44	.44	11/16-16 UN	.75	1, 5, 65
1/2	DT-500-MSMS-**	13/16-16 UN	.51	.50	.51	13/16-16 UN	.88	5, 65
5/8	DT-620-MSMS-**	1-14 UNS	.62	.50	.62	1-14 UNS	1.06	5
3/4	DT-750-MSMS-**	1-3/16 - 12 UN	.68	.50	.68	1-3/16 - 12 UN	1.25	1, 5, 65
1	DT-1000-MSMS-**	1-7/16 - 12 UN	.70	.62	.70	1-7/16 - 12 UN	1.50	5, 65
1-1/4	DT-1250-MSMS-**	1-11/16 - 12 UN	.70	1.06	.70	1-11/16 - 12 UN	1.88	1, 5

Flow Data

DT Series (1/4" & 3/8")
Test Fluid: Oil - 200 SUS

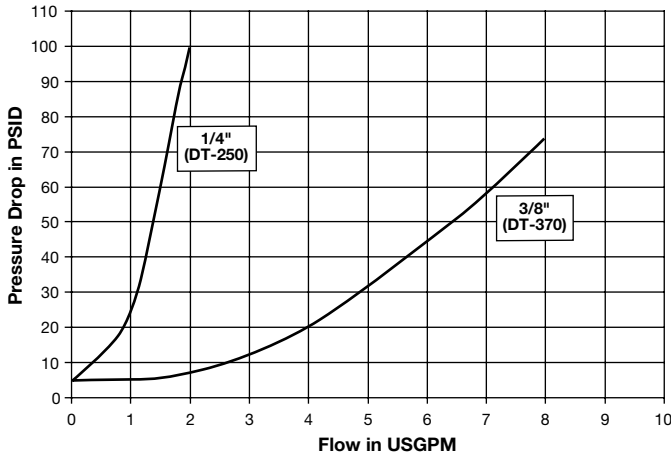

DT Series (1/2", 5/8" & 3/4")
Test Fluid: Oil - 200 SUS

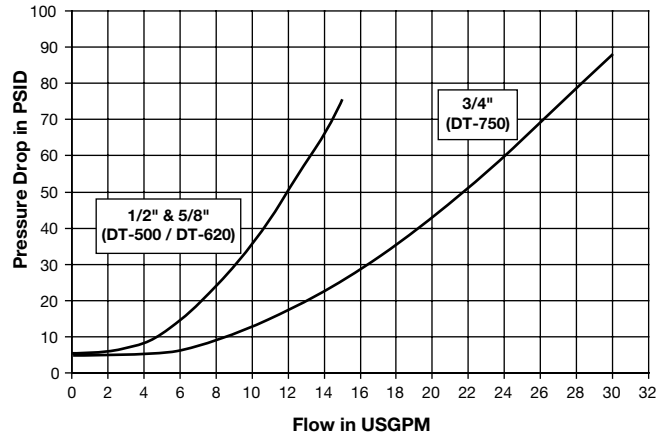

DT Series (1" & 1-1/4")
Test Fluid: Oil - 200 SUS

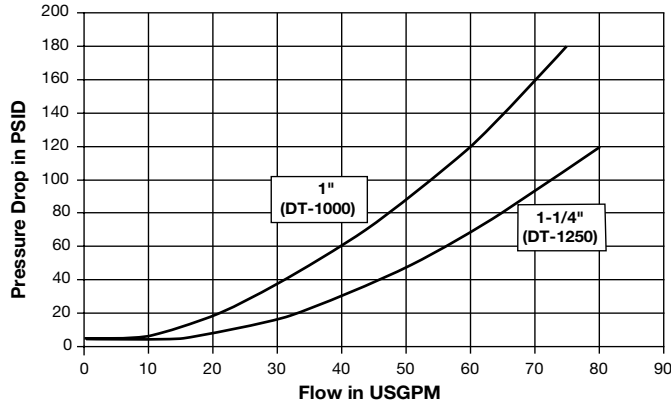

Specifications

Series	Body Size (in.)	Material	Rated Pressure (psi)	Crack Pressure Range (psi)
DT Series	1/4 - 1 1/4	Steel	2500-5000	5-200

DT Series Pressure Table (psi)

Body Size	Max Rated Pressure	MF (Male JIC 37)	M0 (SAE O-Ring Boss)	MS (Male Seal-Lok)
1/4	5000	5000	5000	5000
3/8	5000	5000	5000	5000
1/2	5000	4500	5000	5000
5/8	5000	3500	5000	5000
3/4	5000	3500	5000	5000
1	5000	3000	5000	5000
1 1/4	4000	2500	4000	4000

DT Series Installation Assembly Torque (ft-lbs)

Body Size	MF (Male JIC 37)	M0 (SAE O-Ring Boss)	MS (Male Seal-Lok)
1/4	Refer to Parker TFD Catalog 4300 for torque recommendation	13.3 +10% / -0%	Refer to Parker TFD Catalog 4300 for torque recommendation
3/8		22.1 +10% / -0%	
1/2		62.6 +10% / -0%	
5/8		84.8 +10% / -0%	
3/4		125.3 +10% / -0%	
1		199 +10% / -0%	
1 1/4	210 +10% / -0%	210 +10% / -0%	

Ordering Information

DT - * * * - * * * * - * *

SERIES	SIZE	FITTING STYLE
250	1/4"	MFMF - Male Flare Inlet to Male Flare Outlet
370	3/8"	MFMO - Male Flare Inlet to Male O-Ring Boss Outlet
500	1/2"	MOMF - Male O-Ring Boss Inlet to Male Flare Outlet
620	5/8"	MOMS - Male O-Ring Boss Inlet to Male Face Seal Outlet
750	3/4"	MSMO - Male Face Seal Inlet to Male O-Ring Boss Outlet
1000	1"	MSMS - Male Face Seal Inlet to Male Face Seal Outlet
1250	1-1/4"	

CRACK PRESSURE
 1 = 1 PSI
 5 = 5 PSI
 65 = 65 PSI
 Other Crack Pressures up to 200 PSI in 5 PSI increments are available. Contact the Division for price and delivery on non-standard crack pressures



CV Series Check Valves Offer Low Pressure Drop and High Flow.

Parker's CV Series check valves are a rugged built and versatile product designed to protect hydraulic systems from fluid back pressure. The CV Series compliments the DT Series by adding the feature of modular design. The larger body results in less pressure drop and increased performance. The CV Series are in-line unidirectional valves, available in sizes 1/4" to 1", with a pressure rating of up to 3000 PSI, and flow capacities to 100 GPM. Standard spring crack pressures are 5 and 65 PSI. Other crack pressures available upon request.

Features

1. Nitrile O-ring is standard in the body assembly. Note port O-rings are included on the MO and MS ports.
2. All-steel construction
3. Valve seats resist damage from shocks, surges and contamination.
4. Poppet has an oil retention groove that lubricates the bore and eliminates galling.
5. Poppet spring is isolated from the liquid flow stream, minimizing turbulence.
6. Poppet is heat treated to help prevent damage from shocks, surges and galling.
7. Close tolerance fit between poppet and poppet retainer creates a cushion that protects valve from surge shock damage.
8. Optional crack pressures available upon request.

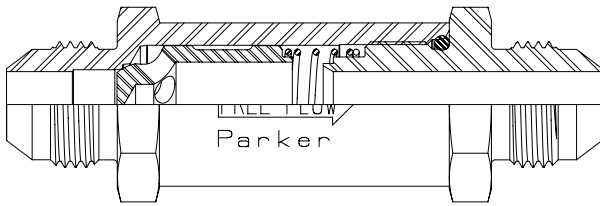
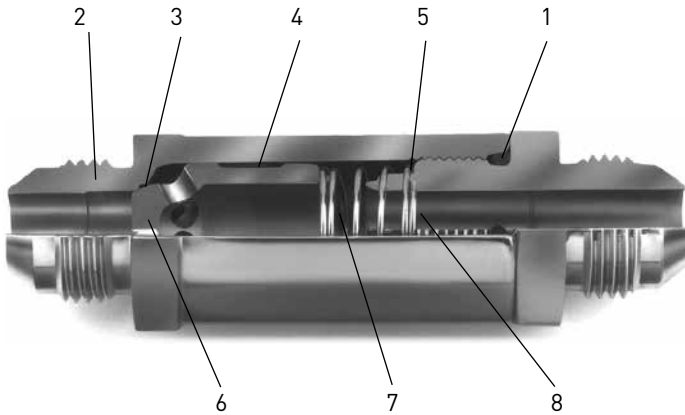

CV-MFMF
Male Flare 37° JIC Inlet to Male Flare 37° JIC Outlet

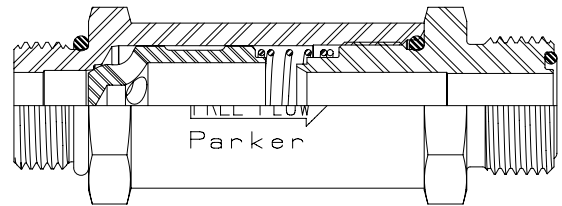

CV-MOMS
Male O-Ring Boss Inlet to Male Seal-Lok® Outlet

NOTE: Contact QCD for additional port end options.

CV-MFMF Male Flare 37° JIC Inlet to Male Flare 37° JIC Outlet

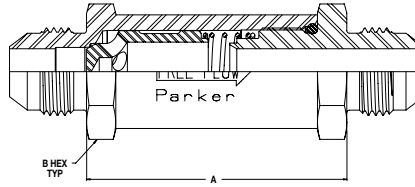

Valve Size	Part Number	Inlet Port Thread	Dimensions (in.)		Outlet Port Thread	** Std Crack Pressure (psi)	Max Operating Pressure (psi)
			Length	Wrench Flats			
			A	B			
1/4	CV-250-MFMF-**	7/16-20 UNF	1.53	.68	7/16-20 UNF	5, 65	3000
3/8	CV-370-MFMF-**	9/16-18 UNF	1.75	.81	9/16-18 UNF	5, 65	3000
1/2	CV-500-MFMF-**	3/4-16 UNF	2.22	1.00	3/4-16 UNF	5, 65	3000
5/8	CV-620-MFMF-**	7/8-14 UNF	2.41	1.12	7/8-14 UNF	5, 65	3000
3/4	CV-750-MFMF-**	1-1/16-12 UN	2.75	1.38	1-1/16-12 UN	5, 65	3000
1	CV-1000-MFMF-**	1-5/16-12 UN	3.31	1.62	1-5/16-12 UN	5, 65	3000

CV-MOMS Male O-Ring Boss Inlet to Male Seal-Lok® Outlet

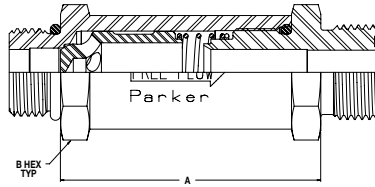

Valve Size	Part Number	Inlet Port Thread	Dimensions (in.)		Outlet Port Thread	** Std Crack Pressure (psi)	Max Operating Pressure (psi)
			Length	Wrench Flats			
			A	B			
1/4	CV-250-MOMS-**	7/16-20 UNF	1.53	.68	9/16-18 UNF	5, 65	3000
3/8	CV-370-MOMS-**	9/16-18 UNF	1.75	.81	11/16-16 UN	5, 65	3000
1/2	CV-500-MOMS-**	3/4-16 UNF	2.22	1.00	13/16-16 UN	5, 65	3000
5/8	CV-620-MOMS-**	7/8-14 UNF	2.41	1.12	1-14 UNS	5, 65	3000
3/4	CV-750-MOMS-**	1-1/16-12 UN	2.75	1.38	1-3/16-12 UN	5, 65	3000
1	CV-1000-MOMS-**	1-5/16-12 UN	3.31	1.62	1-7/16-12 UN	5, 65	3000

E Valves

Flow Data

CV Series (1/4" & 3/8")
Test Fluid: Oil - 200 SUS

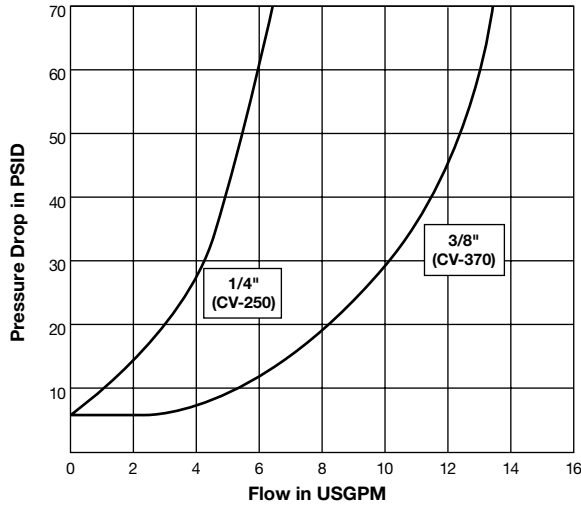

CV Series (1/2", 5/8", 3/4" & 1")
Test Fluid: Oil - 200 SUS

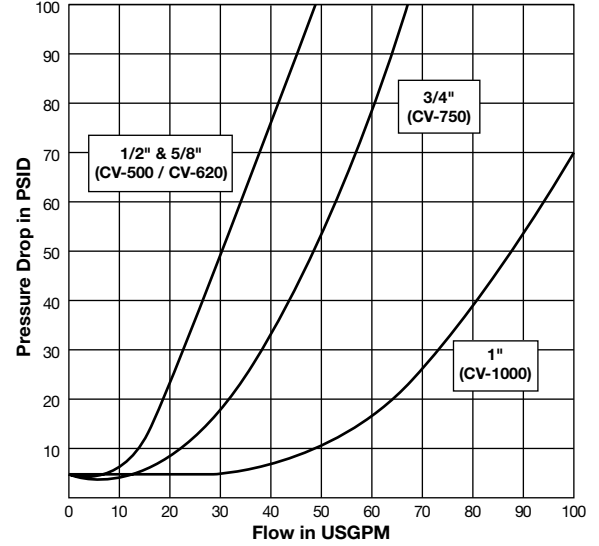

Ordering Information

CV - * * * * - * * * * - * *

CRACK PRESSURE
5 - 5 PSI
65 - 65 PSI
Other Crack Pressures up to 200 PSI in 5 PSI increments are available. Contact the Division for price and delivery on non-standard crack pressures

SERIES	SIZE	FITTING STYLE
250	1/4"	MFMF - Male Flare Inlet to Male Flare Outlet
370	3/8"	MOMS - Male O-Ring Boss Inlet to Male Seal-Lok® Outlet
500	1/2"	
620	5/8"	
750	3/4"	
1000	1"	

NOTE: Contact QCD for additional port end options.

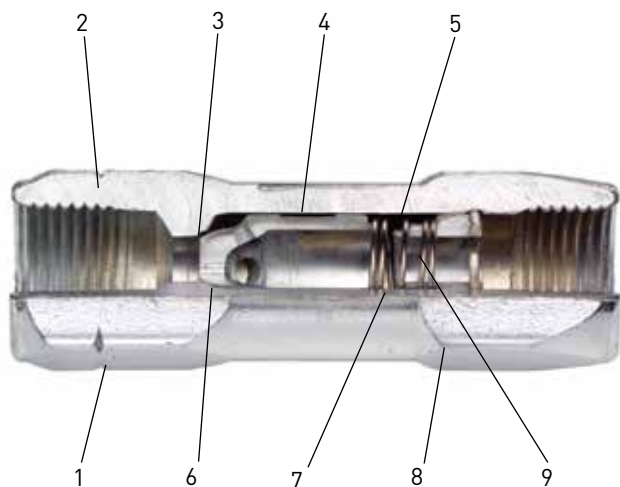

DC Series Check Valves are Rugged, Cost-competitive.

The DC Series offers basic, workhorse check valves – ruggedly built, readily available and reasonably priced. They are in-line valves, available in sizes 1/4” to 2”, with a pressure rating range up to 3000 psi, and flow capacities to 300 GPM.

Features

1. All-steel construction–no internal seals or gaskets to wear out.
2. One-piece body eliminates threads and seals that may be potential failure or leakage points.
3. Valve seats resist damage from shocks, surges and contamination.
4. Poppet has an oil retention groove that lubricates the bore and eliminates galling.
5. Poppet spring is isolated from the liquid flow stream, minimizing turbulence.
6. Poppet is heat treated to help prevent damage from shocks, surges and galling.
7. Close tolerance fit between poppet and poppet retainer creates a cushion that protects valve from surge shock damage.
8. Check valve body is shaped like an arrow to indicate flow direction.
9. Available in a variety of standard and non-standard crack pressures.

DC Series- Part Numbers

Valve Size	Part Number	Inlet Port Thread	Dimensions (In.)		Outlet Port Thread	** Std Crack Pressure (psi)	Max Operating Pressure (psi)
			Length	Wrench Flats			
1/4	DC-250-**	1/4 - 18 NPSF	2.44	0.81	1/4 - 18 NPSF	1, 5, 65	3000
1/4	DC-250-FOFO-**	.438 - 20 UNF	2.44	0.81	.438 - 20 UNF	1, 5	3000
3/8	DC-370-**	3/8 - 18 NPSF	2.75	0.88	3/8 - 18 NPSF	1, 5, 65	3000
3/8	DC-370-FOFO-**	.562 - 18 UNF	2.75	0.88	.562 - 18 UNF	5	3000
1/2	DC-500-**	1/2 - 14 NPSF	3.5	1.06	1/2 - 14 NPSF	1, 5, 65	3000
1/2	DC-500-FOFO-**	.750 - 16 UNF	3.5	1.06	.750 - 16 UNF	5, 65	3000
3/4	DC-750-**	3/4 - 14 NPSF	3.88	1.37	3/4 - 14 NPSF	1, 5, 65	3000
3/4	DC-750-FOFO-**	1.062 - 12 UN	3.88	1.37	1.062 - 12 UN	5, 65	3000
1	DC-1000-**	1 - 11.5 NPSF	4.88	1.62	1 - 11.5 NPSF	5, 65	3000
1	DC-1000-FOFO-**	1.312 - 12 UN	4.88	1.62	1.312 - 12 UN	5, 65	3000
1-1/4	DC-1250-**	1-1/4 - 11.5 NPTF	5.94	2.00	1-1/4 - 11.5 NPTF	5, 65	3000
1-1/4	DC-1250-FOFO-**	1.625 - 12 UN	5.94	2.00	1.625 - 12 UN	5, 65	3000
1-1/2	DC-1500-**	1-1/2 - 11.5 NPTF	6.37	2.38	1-1/2 - 11.5 NPTF	5, 65	3000
1-1/2	DC-1500-FOFO-**	1.875 - 12 UN	6.37	2.38	1.875 - 12 UN	5, 65	3000
2	DC-2000-**	2 - 11.5 NPTF	7.00	3.00	2 - 11.5 NPTF	5, 65	3000
2	DC-2000-FOFO-**	2.500 - 12 UN	7.00	3.00	2.500 - 12 UN	65	3000

Flow Data

DC Series (1/4")
Test Fluid: Oil - 200 SUS

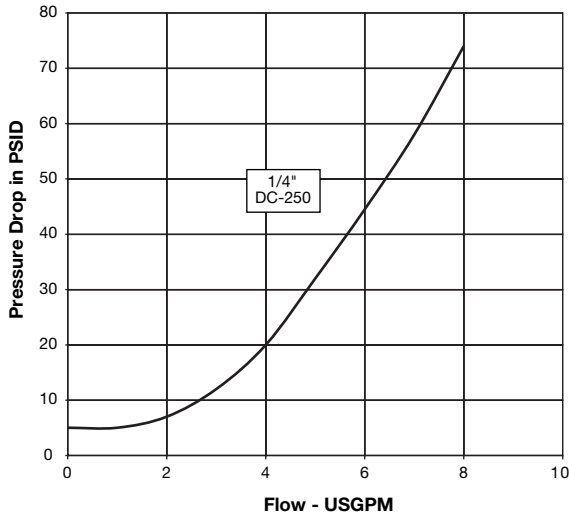

DC Series (3/8", 1/2" & 3/4")
Test Fluid: Oil - 200 SUS

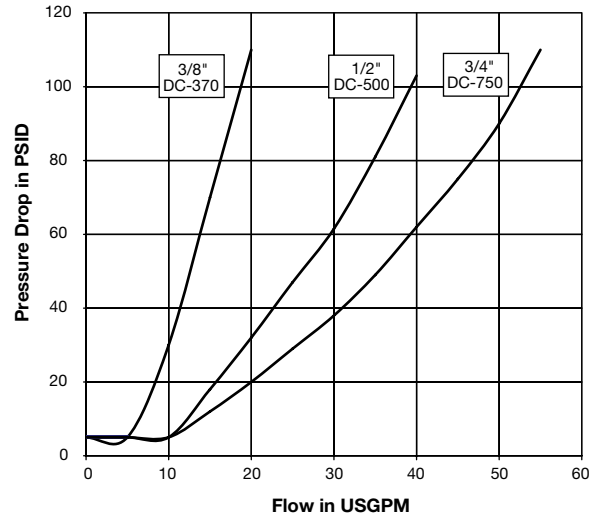

DC Series (1", 1-1/4", 1-1/2" & 2")
Test Fluid: Oil - 200 SUS

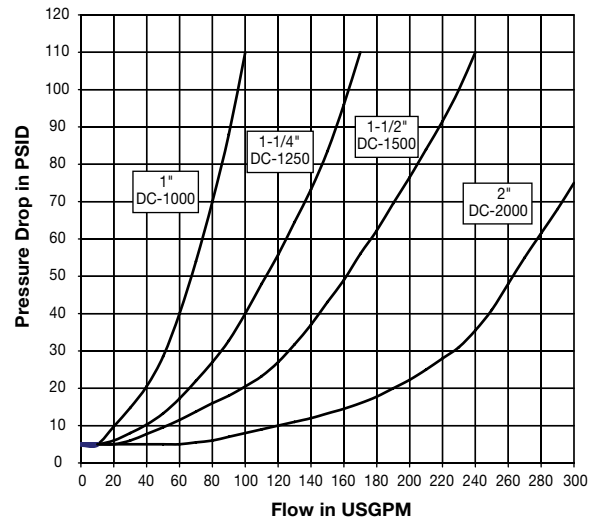

Ordering Information

DC - * - * - * - * - * - *

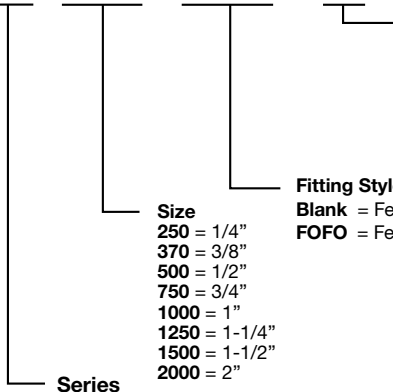

Crack Pressure:

- 1 = 1 PSI
 - 5 = 5 PSI
 - 65 = 65 PSI
- Other crack pressures up to 100 PSI (in 5 PSI increments) are available. Contact the Division for price and delivery on non-standard crack pressures.

Fitting Style:

- Blank = Female pipe inlet to Female pipe outlet
- FOFO = Female O-ring Boss inlet to Female O-ring Boss outlet

- Size
- 250 = 1/4"
 - 370 = 3/8"
 - 500 = 1/2"
 - 750 = 3/4"
 - 1000 = 1"
 - 1250 = 1-1/4"
 - 1500 = 1-1/2"
 - 2000 = 2"



CPIFF Series Soft Seat Check Valves provide a positive shut off to prevent reverse flow.

CPIFF Series check valves are designed to protect hydraulic systems from fluid back pressure. The poppet is streamlined with minimum restriction of flow in one direction. Flow is blocked in the reverse direction as the soft seat creates a leak free seal in the closed position.

These in-line unidirectional valves are available in sizes 1/4" to 1" with a pressure rating up to 5000 psi. Standard spring crack pressures are shown in the part number table. Other crack pressures available upon request.

Features

1. Fluorocarbon poppet seal is standard.
2. Steel construction
3. Optional crack pressures available on request

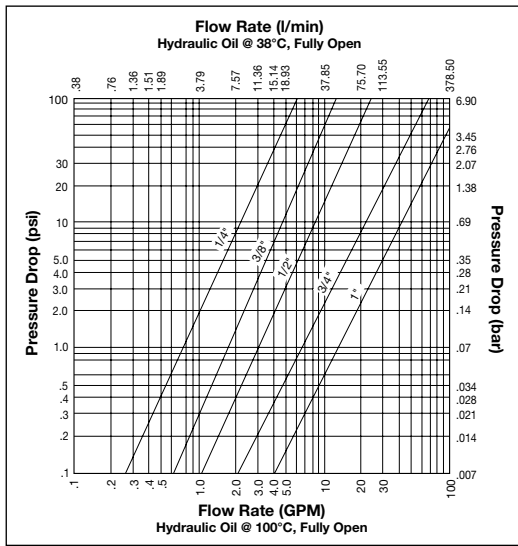

Specifications		
Size (in)	Max Pressure (psi)	Rated Flow (gpm)
1/4	5000	3
3/8	5000	8
1/2	5000	12
3/4	5000	20
1	5000	30

Seal Options (add code to part number)	
Code	Poppet Seal Material
suffix A	Nitrile
suffix E	Ethylene Propylene

CPIFF Series Part Numbers



Valve Size	Part Number	Inlet and Outlet Port Threads (Female)	Dimensions (In.)		Standard Seal Material	** Std Crack Pressure (psi)	Max Operating Pressure (psi)
			Length	Wrench Flats			
1/4	CPIFF-2P-**	1/4 - 18 NPSF	1.97	3/4	Fluorocarbon	5, 15, 25, 65	5000
3/8	CPIFF-3P-**	3/8 - 18 NPSF	2.60	1	Fluorocarbon	5, 15, 25, 65	5000
1/2	CPIFF-4P-**	1/2 - 14 NPSF	3.25	1-1/4	Fluorocarbon	5, 15, 25, 65	5000
1/2	CPIFF-8S-**	3/4 - 16 UNF	3.25	1-1/4	Fluorocarbon	5, 15, 25, 65	5000
3/4	CPIFF-6P-**	3/4 - 14 NPSF	4.33	1-3/8	Fluorocarbon	5, 15, 25, 65	5000
3/4	CPIFF-12S-**	1-1/16 - 12 UN	4.33	1-3/8	Fluorocarbon	5, 15, 25, 65	5000
1	CPIFF-8P-**	1 - 11-1/2 NPSF	4.78	1-3/4	Fluorocarbon	5, 15, 25, 65	5000
1	CPIFF-16S-**	1-5/16 - 12 UN	4.78	1-3/4	Fluorocarbon	5, 15, 25, 65	5000



S6C and 3C Soft Seat Check Valves span a wide variety of sizes and end configurations.

S6C and 3C check valves have a variety of options enabling them to meet the needs of most systems. The soft seated poppet creates a leak free seal to protect hydraulic systems from reverse flow.

S6C check valves are stainless steel with a rated pressure of 6000 psi (sizes 1/4", 3/8", 1/2", 3/4" & 1"). 3C check valves are steel with a rated pressure of 3000 psi (sizes 1-1/4", 1-1/2" & 2").

These in-line unidirectional valves are available in sizes 1/4" to 2". Standard spring crack pressures are shown in the part number table. Other crack pressures available upon request.

Features

1. Fluorocarbon poppet seal is standard.
2. Steel or stainless steel construction
3. Optional crack pressures available on request
4. Contact QCD for other materials or configurations

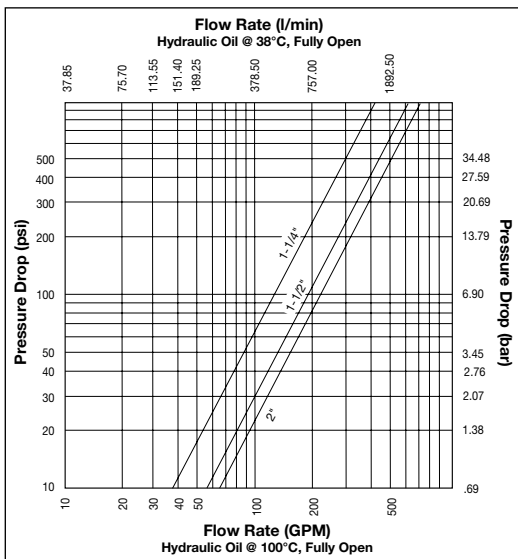
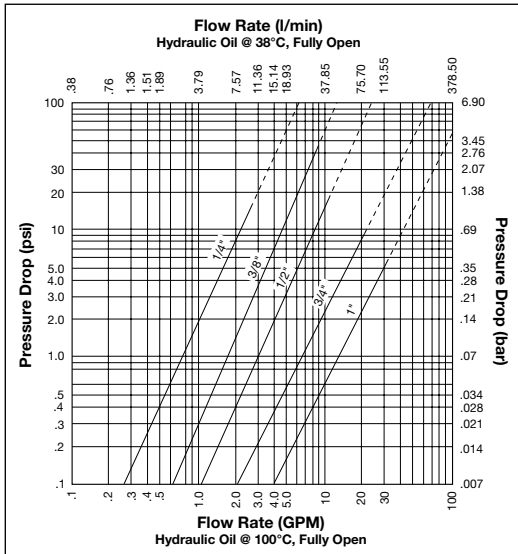

Specifications	
Size (in)	Rated Flow (gpm)
1/4	3
3/8	8
1/2	12
3/4	20
1	30
1-1/4	90
1-1/2	125
2	175

Seal Options (add code to part number)	
Code	Poppet Seal Material
suffix A	Nitrile
suffix E	Ethylene Propylene

S6C Series Part Numbers



Valve Size	Part Number	Inlet Port Threads	Dimensions (In.)		Outlet Port Threads	Standard Seal Material	** Std Crack Pressure (psi)	Max Operating Pressure (psi)
			Length	Wrench Flats				
1/4	S6C4F-F*	1/4 - 18 NPTF (female)	2.82	3/4	1/4 - 18 NPTF (female)	Fluorocarbon	5, 25, 65	6000
1/4	S6C4F-M*	1/4 - 18 NPTF (female)	2.65	3/4	1/4 - 18 NPT (male)	Fluorocarbon	5, 25, 65	6000
1/4	S6C4M-M*	1/4 - 18 NPT (male)	2.70	3/4	1/4 - 18 NPT (male)	Fluorocarbon	5, 25, 65	6000
3/8	S6C6F-F**	3/8 - 18 NPTF (female)	3.38	1-1/8	3/8 - 18 NPTF (female)	Fluorocarbon	5, 25, 65	6000
3/8	S6C6F-M*	3/8 - 18 NPTF (female)	3.18	1-1/8	3/8 - 18 NPT (male)	Fluorocarbon	5, 25, 65	6000
1/2	S6C8F-F*	1/2 - 14 NPTF (female)	3.73	1-1/4	1/2 - 14 NPTF (female)	Fluorocarbon	5, 25, 65	6000
1/2	S6C8M-F*	1/2 - 14 NPT (male)	4.20	1-1/4	1/2 - 14 NPTF (female)	Fluorocarbon	5, 25, 65	6000
1/2	S6C8M-M*	1/2 - 14 NPT (male)	4.04	1-1/4	1/2 - 14 NPT (male)	Fluorocarbon	5, 25, 65	6000
3/4	S6C12F-F*	3/4 - 14 NPTF (female)	4.91	1-5/8	3/4 - 14 NPTF (female)	Fluorocarbon	5, 25, 65	5000
1	S6C16F-F*	1 - 14 NPTF (female)	6.06	1-7/8	1 - 14 NPTF (female)	Fluorocarbon	5, 25, 65	4000

3C Series Part Numbers



Valve Size	Part Number	Inlet and Outlet Port Threads (Female)	Dimensions (In.)		Standard Seal Material	** Std Crack Pressure (psi)	Max Operating Pressure (psi)
			Length	Wrench Flats			
1-1/4	3C20F-F**	1-1/4 - 11-1/2 NPTF	5.76	2	Fluorocarbon	5, 15, 25, 65	3000
1-1/4	3C20EF-EF**	1-5/8 - 12 UN	5.76	2	Fluorocarbon	5, 15, 25, 65	3000
1-1/4	3C20EM-EM**	1-5/8 - 12 UN (male 37° flare)	6.57	2	Fluorocarbon	5, 15, 25, 65	3000
1-1/2	3C24F-F**	1-1/2 - 11-1/2 NPTF	6.50	2-1/2	Fluorocarbon	5, 15, 25, 65	3000
1-1/2	3C24EF-EF**	1-7/8 - 12 UN	6.50	2-1/2	Fluorocarbon	5, 15, 25, 65	3000
2	3C32EF-EF**	2-1/2 - 12 UN	7.28	3-1/4	Fluorocarbon	5, 25, 65	3000

E Valves



Low Pressure and Lightweight

Constructed of lightweight aluminum, the 2600 Series Swing Check Valve has a spring-loaded, trapdoor style valve. The valve opens when system pressure approaches 1/2 psi to permit full flow with low pressure drop. As system pressure is relieved, the valve closes, retaining fluids upstream.

Parker’s 2600 Series are in-line check valves designed especially for diesel and gasoline engine fuel lines. They are also used for externally mounted oil filters, and coolers, as well as transmission fluid lubrication lines. With a maximum of 1/2 psi cracking pressure, these Swing Check Valves are useful in most low pressure air, liquid, or gas systems.

Features

- Lightweight, corrosion-resistant aluminum construction.
- Available with 1/4” or 3/8” NPTF ports.
- Standard Nitrile or Fluorocarbon seals.
- 1/2 PSI maximum crack pressure.
- Trapdoor style valve permits full flow with low pressure drop.

2600 Series Specifications	
Rated Pressure	250 psi max
Crack Pressure	1/2 psi max
Weight	0.08 lbs
Temperature Range	Nitrile: -40° to 200°F (-40° C to 93° C) Fluorocarbon: -40° to 400°F (-40° C to 204° C)
Max Leakage	5 cc / 24 hours at 28” head
Rated Flow	6 gpm (based on 3/8” hose size)

2600 Series Part Numbers				
Part Number	Thread	Seal Material	Dimensions	
			Length (mm)	Wrench Flats (in)
2600	1/4 - 18NPTF	Nitrile	2.06 (52)	1-1/16
2676	1/4 - 18NPTF	Fluorocarbon	2.06 (52)	1-1/16
2650	3/8 - 18NPTF	Nitrile	2.12 (54)	1-1/16
2625	3/8 - 18NPTF	Fluorocarbon	2.12 (54)	1-1/16



H1 Series Pressure/Vacuum Relief Valves are used to maintain positive pressure in hydraulic reservoirs. The compact size, reusable bronze filter and high flow characteristics make this valve a popular choice.

The HM1 Series offers the same features and characteristics as the H1 series with the option of manual over ride. This feature allows the operator to relieve the reservoir pressure before opening the tank for refilling, inspection or servicing.

Features

- Easy to remove, cleanable bronze filter.
- High flow characteristics.
- Compact size.
- Available with male pipe or male ORB threads.
- Wide variety of pressure relief settings.
- HM1 series has a manual pressure relief button.

H1 and HM1 Series Specifications		
	H1 Series	HM1 Series
Pressure Rating	60 psi max	
Filter Rating	10 micron, nominal	
Pressure Relief Setting	5 psi through 50 psi (in 5 psi increments)	
Vacuum Relief Setting	0.3 psi	
Weight	1.0 lbs	1.1 lbs

Flow Data H1 and HM1 Pressure-Vacuum Relief Valve

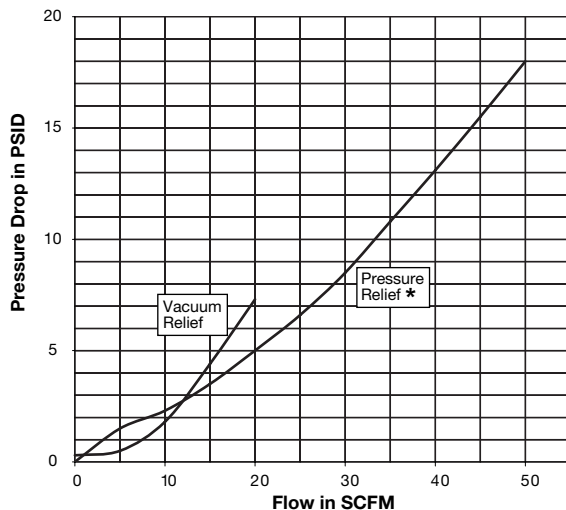

* Pressure drop is pressure relief valve crack pressure until pressure drop curve increases above pressure relief crack pressure.

Ordering Information

H * - * * - * * * *

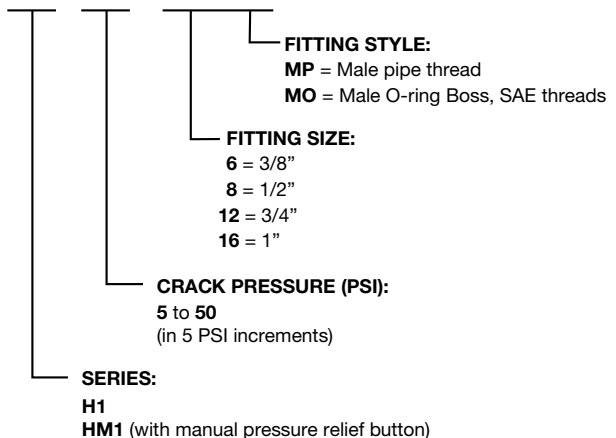



PV Series is an economical Pressure/Vacuum Relief Valve used to maintain positive pressure in hydraulic reservoirs. The large filter area makes this valve an ideal choice for use in heavily contaminated environments. The optional bayonet type mount allows the valve to be installed in the tank filler port, eliminating the need for an extra port. In this configuration, the valve also serves as a filler cap.

Features

- Disposable spin-on automotive type, field replaceable filter (240 sq inches).
- Several pressure relief settings.
- Economic design.
- Optional bayonet style allows mounting in filler port with valve also functioning as filler cap.

PV Series Specifications		
	PV Series	PV Bayonet Style
Filter Rating	10 micron, nominal (240 sq inches)	
Pressure Relief Setting	5 PSI through 30 PSI (in 5 PSI increments)	5 and 10 PSI
Vacuum Relief Setting	0.3 PSI	
Weight	1.0 lb.	
Mounting	Male ORB, SAE threads Male pipe threads	Bayonet style with tank receptacle gaskets & screws (optional strainer basket)
Replacement Filter Part Number	7312-009	

Flow Data PV Pressure-Vacuum Relief Valve

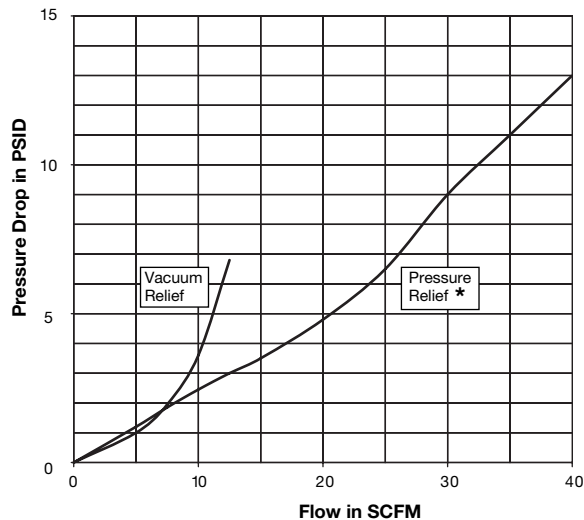

* Pressure drop is pressure relief valve crack pressure until pressure drop curve increases above pressure relief crack pressure.

Ordering Information

PV - ** - * - ****

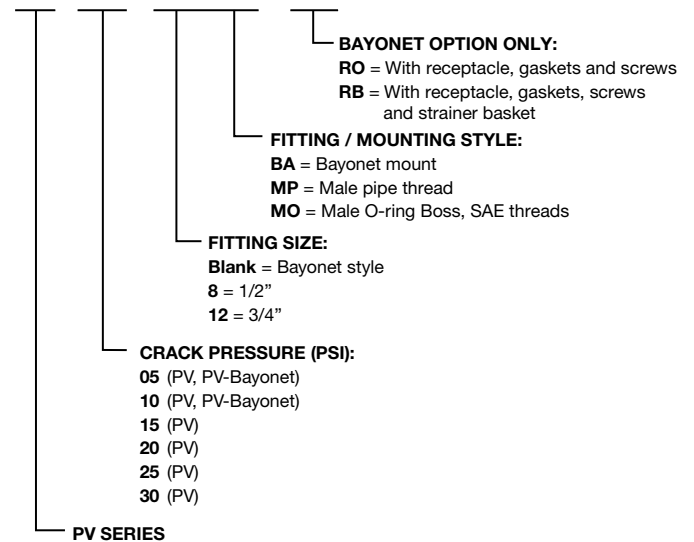

E Valves



Maintain Optimum Fluid Temperature

Parker's thermal bypass valve will modulate fluid temperature by shifting return line flow through the cooler, or bypassing it directly to the reservoir.

Additionally, an integral pressure relief function automatically releases excess pressure to the reservoir if the cooler becomes restricted, and the inlet pressure becomes excessive. Relief crack pressure settings range from 5 to 85 PSI.

These lightweight, aluminum valves are ideal for hydrostatic drive circuits requiring fast warm-up, controlled fluid temperatures, and low return line back pressure.

Features

- Lightweight, corrosion-resistant aluminum housing.
- Available in five shift temperatures.
- Integral relief valve to dump excessive inlet pressures to the reservoir.
- 250 PSI maximum operating pressure.
- Up to 60 GPM flow rates.

Flow Data

Pressure Drop (Mobil DTE 26 oil)

**Inlet Port thru Tank Port
@ 100°F (300 SUS)**

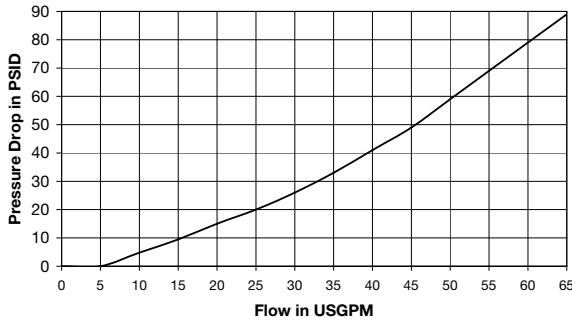

**Inlet Port over Integral Relief Valve
@ 170°F (78 SUS Oil)**

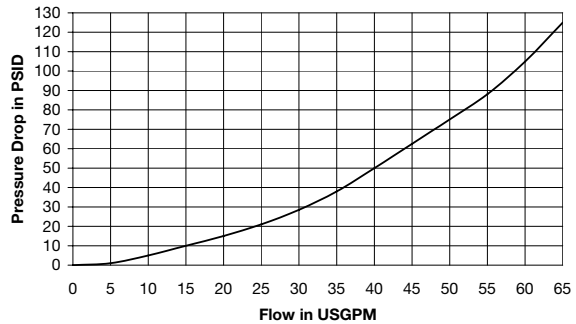

**Inlet Port thru Cooler Port
@ 145°F (110 SUS Oil)**

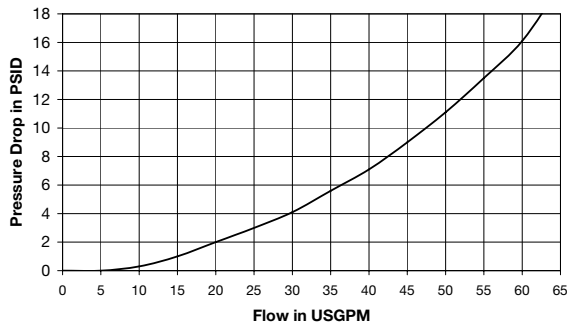

E Valves

TH Series Specifications	
Size	1 inch
Weight	2.00 lbs
Std Shift Temperatures	100° F (38° C), 120° F (49° C), 140° F (60° C), 160° F (71° C), 180° F (82° C)
Full Shift Temperature (cooler port open)	Shift Temperature plus 25° F (14° C)
Proof Pressure	300 PSI (21 bar)
Minimum Burst Pressure	Up to full shift temperature: 325 PSI (22 bar) Above full shift temperature: 600 PSI (41 bar)
Operating Temperature	Min: -30° F (-34° C) Max: Shift temperature plus 75° F (24° C)
Max Flow Rate	60 GPM (227 l/m)

Dimensions

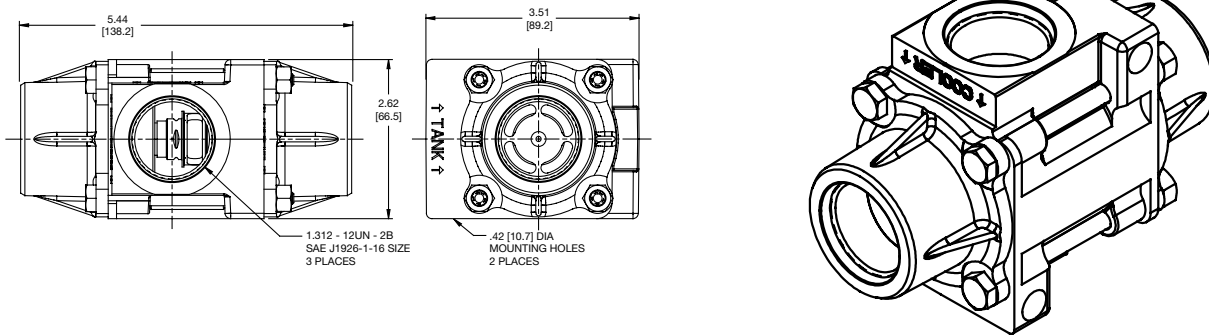

Ordering Information

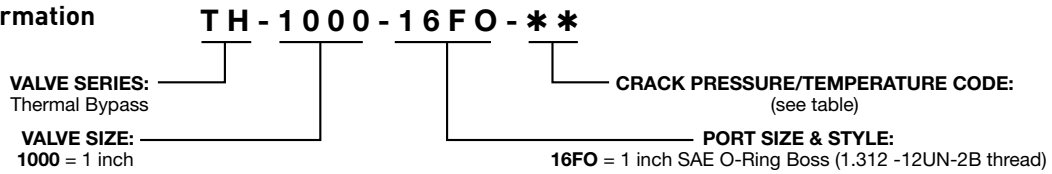

Shift Temperature	Crack Pressure PSI																	
	5	10	15	20	25	30	35	40	45	50	55	60	65	70	75	80	85	
100° F (38° C)	01	02	03	04	05	06	07	08	09	10	11	12	13	14	15	16	17	
120° F (49° C)	21	22	23	24	25	26	27	28	29	30	31	32	33	34	35	36	37	
140° F (60° C)	41	42	43	44	45	46	47	48	49	50	51	52	53	54	55	56	57	
160° F (71° C)	61	62	63	64	65	66	67	68	69	70	71	72	73	74	75	76	77	
180° F (82° C)	81	82	83	84	85	86	87	88	89	90	91	92	93	94	95	96	97	



aerospace
 climate control
 electromechanical
 filtration
 fluid & gas handling
 hydraulics
 pneumatics
 process control
 sealing & shielding



Quick Coupling Products

Quick Couplings, Swivels, Valves,
 Diagnostic Equipment
 Catalog 3800 USA | February 2014



ENGINEERING YOUR SUCCESS.

Quick Coupling Division Locations



Minneapolis, MN



Grantsburg, WI



Chetek, WI



Union City, PA

WARNING

FAILURE OR IMPROPER SELECTION OR IMPROPER USE OF THE PRODUCTS DESCRIBED HEREIN OR RELATED ITEMS CAN CAUSE DEATH, PERSONAL INJURY AND PROPERTY DAMAGE.

- This document and other information from Parker-Hannifin Corporation, its subsidiaries and authorized distributors provide product or system options for further investigation by users having technical expertise.
- The user, through its own analysis and testing, is solely responsible for making the final selection of the system and components and assuring that all performance, endurance, maintenance, safety and warning requirements of the application are met. The user must analyze all aspects of the application, follow applicable industry standards, and follow the information concerning the product in the current product catalog and in any other materials provided from Parker or its subsidiaries or authorized distributors.
- To the extent that Parker or its subsidiaries or authorized distributors provide component or system options based upon data or specifications provided by the user, the user is responsible for determining that such data and specifications are suitable and sufficient for all applications and reasonably foreseeable uses of the components or systems.

Offer of Sale

The items described in this document are hereby offered for sale by Parker Hannifin Corporation, its subsidiaries or its authorized distributors. This offer and its acceptance are governed by the provisions stated in the "Offer of Sale."

Table of Contents

- Pneumatic Quick Couplings.....Section A**
- Hydraulic Quick Couplings.....Section B**
- Thermoplastic Couplings.....Section C**
- Swivels.....Section D**
- Valves.....Section E**
- Diagnostic Products.....Section F**

- Appendices:**
- Fluid Compatibility Chart.....I**
- Safety Guide.....VI**
- Offer of Sale.....IX**
- Glossary of Terms.....X**



Diagnostic Products



Diagnostics – A Wise Investment

When time is money... In today's "Lean" environment there is more emphasis put on increased production and reduced downtime than ever before. You can't afford to have your equipment sitting idle. Momentary pressure spikes and flow surges that are not recognized by other conventional mechanical measuring devices can unexpectedly destroy both components and systems.

An ounce of prevention... Diagnosing a problem before it occurs should be your primary objective. Whether it is a piece of mobile construction equipment, or an automated industrial assembly machine, lost production is lost profits. The basic prescription for system maintenance is prevention.

Hydraulic and pneumatic... Parker's SensoControl product line is a valuable tool for diagnosing problems both before and after they occur. Today's hydraulic and pneumatic systems are continuously becoming more sophisticated. Being able to identify critical information for optimizing machine efficiencies is a necessity.



Table of Contents

Introduction	F-1	Test Port Couplings	F-23 to F-32
Table of Contents	F-2	Coupling Selection Guide	F-3
Meter Selection Guide	F-3	PD Series	F-23
The Parker ServiceJunior™	F-4	Dust Cap	F-23
Diagnostic Tee Kits	F-5	Couplers	F-24
The Parker Serviceman Plus™	F-6	Nipples	F-24, F-25, F-26
Diagnostic Meter Versions	F-7	PDP Series	F-27
Diagnostic Meter Kits	F-8	Dust Cap	F-27
The Parker Service Master Easy™	F-10	Couplers	F-28
Diagnostic Meter Kits	F-12	Nipples	F-28
The Parker Service Master Plus™	F-13	EMA3 Series	F-29
Diagnostic Instrument Kits	F-15	Nipples	F-29, F-30
Meters and Accessories Selection Guide	F-16, F-17	Gauge Adapter & Union	F-30
Components and Accessories	F-18 to F-22	Transducer Adapters	F-31
Pressure Transducers	F-18, F-19	Flexible Hose	F-31
Flow Sensors	F-20, F-21	PDFS Series - Fluid Sampling	F-32
Temperature Sensor	F-22	Couplers	F-32
Tachometer	F-22	Nipples	F-32
Voltage Adapter	F-22		
Cables	F-22		
Frequency Converter	F-22		



Meter Selection Guide

	The Parker Service Junior	The Parker Serviceman Plus	The Parker Service Master Easy	The Parker Service Master Plus
Pressure Sensing	■	■	■	■
Flow Sensing		■	■	■
Temperature Sensing		■	■	■
Rotational Speed Sensing		■	■	■
Auxiliary Sensing		■	■	■
Pressure Differential		■	■	■
Automatic Sensor Recognition		■	■	■
Frequency Sensing		■	■	■
Auto Power Off	■	■	■	■
Battery Monitoring	■	■	■	■
Battery Type	AA (2 req'd)	Rechargeable LI-ion	Rechargeable Ni-MH	Rechargeable LI-ion
PC Compatible (Windows 7)		■	■	■
Minimum/Maximum Memory	■	■	■	■
Self Contained Memory		■	■	■
On-Line Data Transfer		■	■	■
Text Display (Lines)	2	4	8	48
Inputs	1	2-3	4	26
Data Points (Maximum in Memory)		270,000	1,000,000	1,000,000,000
Numbered LCD Display	■	■	■	■
Basic Hydraulic Calculations		■	■	■
USB Interface		■	■	■
CAN Sensors		■		■
Graphic Color Display				■
Additional Storage Media		■		■

The Parker Serviceman Plus, Parker Service Master Easy and the Parker Service Master Plus require the appropriate sensors to perform measurement functions.

Test Port Coupling Selection Guide									
Test Port	Valving Style	Body Size	Material*			Locking Mechanism	Standard Seal Material	Rated Pressure	Temp Range**
			Br	SS	S				
PD Series	Flush Face	1/8"	■	■	■	Ball	Nitrile	6000 psi	-40° to +250° F
PDP Series	Ball (Nipple only)	1/8"	■	■	■	Ball	Nitrile	6000 psi	-40° to +250° F
EMA3 Series	Poppet	1/8"	■	■	■	Threads	Nitrile/Fluorocarbon	9000 psi	-15° to +250° F

* See Fluid Compatibility chart and/or consult QCD for questions regarding proper material for specific applications.

CODE: Br = Brass; SS = Stainless Steel; S = Steel

** Temperature Range for standard seal material



The Parker ServiceJunior is an integrated digital pressure gauge with minimum/maximum memory capability.

Capabilities:

- Hand held digital pressure gauge
- Measure and Display
-Pressure

Features:

- Easy operation
- Backlit display
- User-adjustable pressure units
- Min/Max memory
- Battery life indicator applications
- Ranges for hydraulics and pneumatics
- Scanning rate of 10ms
- Fluid temperature: -4° to 176° F
- Colored covers correspond with pressure ranges for easy identification

Cover Color Code

Blue	-14.5 to 230 PSI (-1 to 16 bar)
Green	0 to 1500 PSI (0 to 100 bar)
Orange	0 to 5800 PSI (0 to 400 bar)
Red	0 to 8700 PSI (0 to 600 bar)

Part Numbers and Specifications

ServiceJunior with PD Coupler	ServiceJunior with EMA3 Coupler	ServiceJunior with 1/4" NPT Port	Measuring Range	Overload Pressure (psi)	Resolution (psi)	Accuracy
SCJR-0250-PD	SCJR-0250-EMA	SCJR-0250-4MP	-14.5 to 230 PSI (-1 to 16 bar)	580	0.1	0.5% FS
SCJR-1500-PD	SCJR-1500-EMA	SCJR-1500-4MP	0 to 1500 PSI (0 to 100 bar)	2,900	1	
SCJR-5800-PD	SCJR-5800-EMA	SCJR-5800-4MP	0 to 5800 PSI (0 to 400 bar)	11,600	1	
SCJR-8700-PD*	SCJR-8700-EMA**	SCJR-8700-4MP	0 to 8700 PSI (0 to 600 bar)	17,400	1	

* PD Couplers rated to 6,000 PSI max
** EMA3 Couplers rated to 9,000 PSI max

Accessories

Part Number	Description
PD240	PD Series Diagnostic Coupler
SCA-7/16-EMA-3	7/16 - 20UNF-2B female to M16X2.0 EMA3 female swivel
SCJA-1/4	7/16 - 20UNF-2B female to 1/4" NPT male adapter
PDH-19	19" PD Hose extension to be used with PD nipple
PDH-32	32" PD Hose extension to be used with PD nipple
SMA3-400	16" (400 mm) Hose assembly for EMA M16X2.0 interface
SCC-110	Storage case for one gauge and diagnostic adapters
SCC-300	Storage case for three gauges and diagnostic adapters



PD Style Kits

SCJR1-KIT-PD	
1	ServiceJunior Gauge: Range: 0 to 5800 psi (0 to 400 bar)
6	PD style JIC Tee Fittings 1/4 through 1 inch sizes
6	PD style ORFS Tee Fittings 1/4 through 1 inch sizes
1	PD style Whip Hose 32 inch (800 mm) length
1	Case - includes 3 plastic storage compartments

SCJR2-KIT-PD	
1	ServiceJunior Gauge: Range: 0 to 1500 psi (0 to 100 bar)
1	ServiceJunior Gauge: Range: 0 to 5800 psi (0 to 400 bar)
6	PD style JIC Tee Fittings 1/4 through 1 inch sizes
6	PD style ORFS Tee Fittings 1/4 through 1 inch sizes
2	PD style Whip Hoses 32 inch (800 mm) length
1	Case - includes 3 plastic storage compartments

SCJR3-KIT-PD	
1	ServiceJunior Gauge: Range: -14.5 to 230 psi (-1 to 16 bar)
1	ServiceJunior Gauge: Range: 0 to 1500 psi (0 to 100 bar)
1	ServiceJunior Gauge: Range: 0 to 5800 psi (0 to 400 bar)
6	PD style JIC Tee Fittings 1/4 through 1 inch sizes
6	PD style ORFS Tee Fittings 1/4 through 1 inch sizes
3	PD style Whip Hoses 32 inch (800 mm) length
1	Case - includes 3 plastic storage compartments

EMA Style Kits

SCJR1-KIT-EMA	
1	ServiceJunior Gauge: Range: 0 to 5800 psi (0 to 400 bar)
6	EMA style JIC Tee Fittings 1/4 through 1 inch sizes
6	EMA style ORFS Tee Fittings 1/4 through 1 inch sizes
1	EMA style Whip Hose 32 inch (800 mm) length
1	EMA style Union female to male adapter
1	Case - includes 3 plastic storage compartments

SCJR2-KIT-EMA	
1	ServiceJunior Gauge: Range: 0 to 1500 psi (0 to 100 bar)
1	ServiceJunior Gauge: Range: 0 to 5800 psi (0 to 400 bar)
6	EMA style JIC Tee Fittings 1/4 through 1 inch sizes
6	EMA style ORFS Tee Fittings 1/4 through 1 inch sizes
2	EMA style Whip Hoses 32 inch (800 mm) length
2	EMA style Unions female to male adapter
1	Case - includes 3 plastic storage compartments

SCJR3-KIT-EMA	
1	ServiceJunior Gauge: Range: -14.5 to 230 psi (-1 to 16 bar)
1	ServiceJunior Gauge: Range: 0 to 1500 psi (0 to 100 bar)
1	ServiceJunior Gauge: Range: 0 to 5800 psi (0 to 400 bar)
6	EMA style JIC Tee Fittings 1/4 through 1 inch sizes
6	EMA style ORFS Tee Fittings 1/4 through 1 inch sizes
3	EMA style Whip Hoses 32 inch (800 mm) length
3	EMA style Unions female to male adapter
1	Case - includes 3 plastic storage compartments



The Serviceman Plus is an extremely robust, portable and easy-to-use measuring device. With a scan rate of 1 ms and the ability to read pressure, flow, temperature and RPM, it is versatile for use with mobile and industrial systems.

Data can be conveniently saved to a removable nano USB stick or transferred through USB interface to a PC for further analysis with SensoWin software.

The Serviceman Plus is available in two designs. One with two inputs for analog sensors and the other with CAN interface for up to three CAN sensors.

Capabilities:

- Hand held diagnostic meter
- Measure and Display
 - Pressure
 - Flow
 - Rational Speed
 - Temperature

Features:

- Automatic sensor recognition eliminates troublesome and confusing set up
- Large back-lit display MIN/MAX memory and differential measurements
- Increased memory capacity with nano USB stick
- USB interface to PC for convenient analysis and documentation
- Robust design with IP67 rated protection
- Rear support for free-standing operation
- Scan rate of 1 ms

Serviceman Plus Technical Data

Interfaces	Battery
<ul style="list-style-type: none"> • USB device: Online data transfer between device and PC via SensoWin Software: measured value transfer: ACT/MIN/MAX, min. 5 mns; USB standard: 2.0, full speed; connection assembly: Micro USB socket, protected, type B • USB host: Connection of USB memory stick, max. 4 GB; recommended types: Delock USB 2.0 nano memory stick, Intenso Micro Line; USB standard: 2.0, full speed, max. 100 mA; connection assembly: Micro USB socket, protected, type B 	<p>Analog Version:</p> <ul style="list-style-type: none"> • Type: Lithium-ion pack: 3.7 V DC/2250 mAh • Battery charging time with power supply: Approx. 3.5 hours • Battery discharge period: > 8 hours, with 2 sensors <p>CAN Version:</p> <ul style="list-style-type: none"> • Type: Lithium-ion pack: 3.7 V DC/4550 mAh • Battery charging time with power supply: Approx. 7 hours • Battery discharge period: > 8 hours, with 2 CAN-BUS sensors
Memory	Casing
<ul style="list-style-type: none"> • Internal measure value memory: 1 measurement, approx. 15,000 data records (270,000 measure values ACT/MIN/MAX) • USB memory stick: 1 GB supplied 	<ul style="list-style-type: none"> • Material of casing: PC/ABS • Material of casing protective cover: TPU • Dimensions (W x H x D): 96 x 172 x 54 mm • Weight: approx. 540g
Functions	Operating Environment
<ul style="list-style-type: none"> • Difference; addition; output; ACT; MIN; MAX; FS; TEMP display; battery charge; start-stop measurement 	<ul style="list-style-type: none"> • Operating temperature: 0-50°C • Storage temperature: -25-60°C • Relative humidity: <80% • Environmental assessment: DIN EN 60068-2-32 (1 m free fall) • Protection category (EN60529): Analog IP54, CAN IP67
Display	PC Software
<ul style="list-style-type: none"> • Type: FSTN-LCD, graphical with LED background lighting • Visible area: 62 mm x 62 mm • Resolution: 130 x 130 pixels 	<ul style="list-style-type: none"> • Read measurement data, show, analyse on PC; read device settings, edit; load device setting from library to manual measuring device
Voltage (external)	
<ul style="list-style-type: none"> • Micro-USB socket, type B, + 5 V DC max 1000MA 	

F Diagnostic

SCM-155-2-05 CAN Version

CAN Inputs:

- CAN-Bus sensor auto recognition
- Plug connection: 5-pol, M12 x 1, SPEEDCON plug
- Sampling rate P-channel: 1 ms

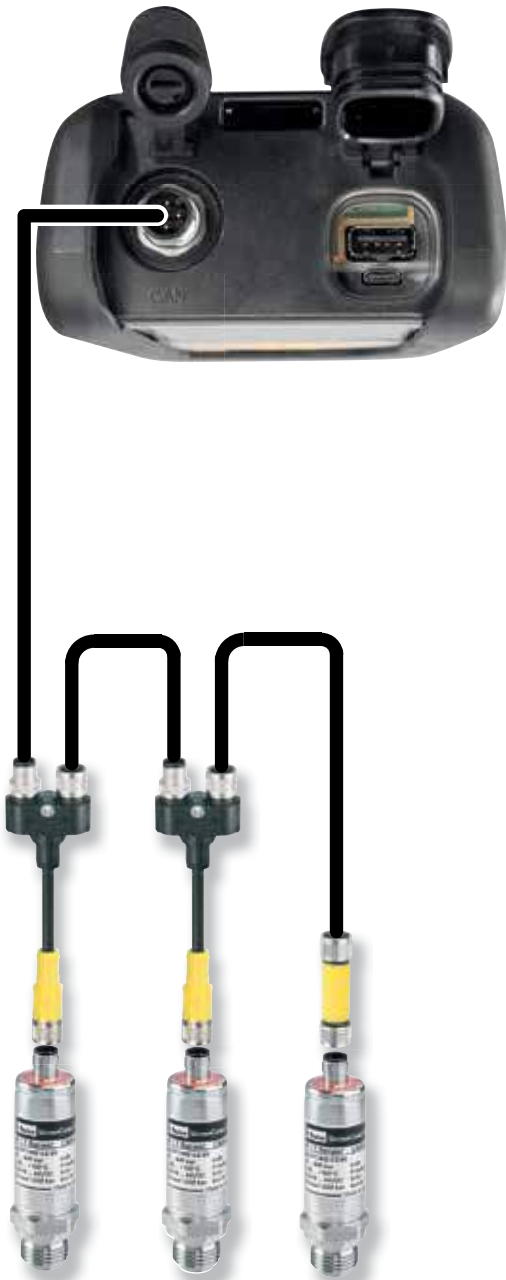

SCM-155-0-02 Analog Version

Analog Inputs:

- Analog sensor auto recognition
- Measurement Precision: +/- 0.02 +/- one digit
- Plug Connection: 5-pol, push-pull
- Sampling rate P-channel: 1 ms





PDS4 (CAN version) Kit Contents:	Part Number
Serviceman Plus (CAN)	SCM-155-2-05
CD with SensoWin, documentation and instructions	CD 4078
Case	SCC-210
CAN Transducers (1 or 2)	PD XXXXX-XXXX-CAN
CAN Transducer Connection Cable (1 or 2 based on transducer #)	SCK-401-05-4F-4M
Power Supply	SCSN-440
CAN Y cable (only included with 2 transducer kit)	SCK-401-0.3-Y
Terminator Resistor	SCK-401-R
Nano USB Stick - 1 GB	SCK-USB-MINISTICK
USB Connection Cable - 1 meter	SCK-315-02-36

PDS4 (Analog version) Kit Contents:	Part Number
Serviceman Plus (Analog)	SCM-155-0-02
CD with SensoWin, documentation and instructions	CD 4078
Case	SCC-210
Analog Transducers (1 or 2)	PD XXXXX-XXXX
Analog Transducer Connection Cable (1 or 2 based on transducer #)	SCK-102-03-02
Power Supply	SCSN-440
Nano USB Stick - 1 GB	SCK-USB-MINISTICK
USB Connection Cable - 1 meter	SCK-315-02-36

F Diagnostic

Code for Ordering Kits:

PDS4 - X - XX - XX - XXX

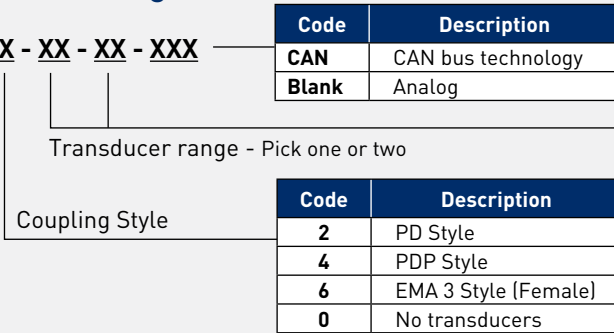

Code	Description
CAN	CAN bus technology
Blank	Analog

Code	Description
2	PD Style
4	PDP Style
6	EMA 3 Style (Female)
0	No transducers

Code	Pressure (psi)	Color
01	-14.5 – 220	Blue
06	0 – 870	Green
15	0 – 2175	Yellow
40	0 – 5800	Orange
60	0 – 8700	Red
00	No transducers	

Additional Transducers - Code for Ordering Separately:

PD XXXX - XXXX - XXX

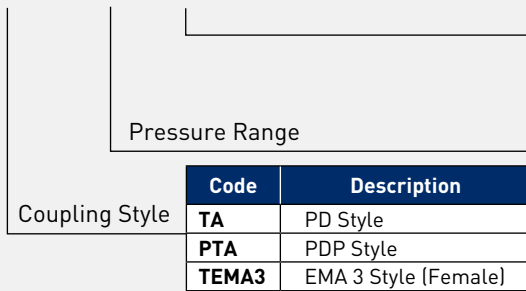

Code	Description
CAN	CAN bus technology
Blank	Analog

Code	Pressure (psi)	Color
0100	-14.5 – 220	Blue
0600	0 – 870	Green
1500	0 – 2175	Yellow
4000	0 – 5800	Orange
6000	0 – 8700	Red

Code	Description
TA	PD Style
PTA	PDP Style
TEMA3	EMA 3 Style (Female)

Flow Sensors - Code for Ordering Separately:

SCFT- XXXX - XXX - XXX

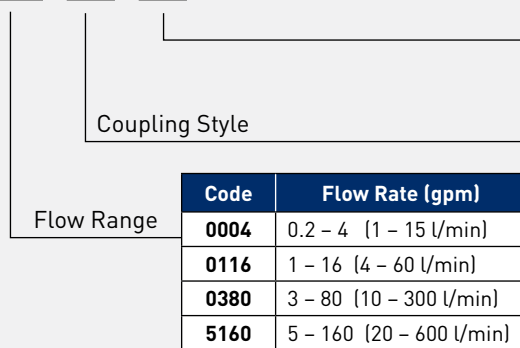

Code	Description
CAN	CAN bus technology
Blank	Analog

Code	Description
PD	PD Style
PDP	PDP Style
EMA	EMA 3 Style

Code	Flow Rate (gpm)
0004	0.2 – 4 (1 – 15 l/min)
0116	1 – 16 (4 – 60 l/min)
0380	3 – 80 (10 – 300 l/min)
5160	5 – 160 (20 – 600 l/min)



The Parker Service Master Easy gives you the ability to measure and store operational parameter data simultaneously, or switch between them with ease.

Capabilities:

- Hand held diagnostic meter
- Measure and Display
 - Pressure
 - Flow
 - Rotational Speed
 - Temperature

Features:

- Four sensor inputs
- Intuitive operation
- Rugged design
- Auto sensor recognition
- Four line numerical display
- Calculated channels
- Store data on device
- SensoWin software utility
- Scan rate of 1ms

Service Master Easy SCM-340-2-02 Technical Data

Functions	Ambient Conditions	Meter
Differential Value Measurement	Operating Temperatures	Digital LCD Text Display
MIN/MAX Memory	32°F to 122°F (0°C to 50°C)	- 128x64 pixels
On line data transfer	Storage Temperatures	- 72x40 mm screen
Battery level indicator	-4°F to 140°F (-20°C to 60°C)	Character Height 6 mm
Power calculation (display only)	Protection class IP54	Display of Pressure, Temperature, Flow and Rotational Speed
Flow run-out (display only)	Housing	
Auto power off	Glass reinforced polyamide	- Pressure in PSI and Bar
Output	12-Key tactile touch membrane	- Temperature in °F and °C
USB 2.0 interface	EMC Protection	- Flow in GPM and l/min.
Power Requirements	- Electromagnetic interference	- Rotational Speed in RPM
Internal rechargeable Ni-MH battery	(DIN/EN 50081, Part 1)	Inputs
Recharge circuit for use with external power supply.	- Immunity to emitted interference	Four 5-pin push-pull style connectors
Operating time - 8 hours	(DIN/EN 50082, Part 2)	Automatic Sensor Recognition for pressure, temperature or rotational speed sensors
Charge time - 3 hours	Dimensions	
Excitation voltage (12-30 VDC)	Length/Height/Width	12 Bit A/D Converter (4096 steps)
Memory Functions	- 9.25 x 4.19 x 2.09	Selectable scanning rate in 1 ms intervals
Memory capacity	- (235 x 106 x 52 mm)	Burst Mode 0.25 ms (input 1 only)
- 1,000,000 data points max	Weight	
- 250,000 points per curve max	1.2 lbs (700 grams)	
Variable measuring period up to 100 hours		
Manual and automatic triggering		

F Diagnostic

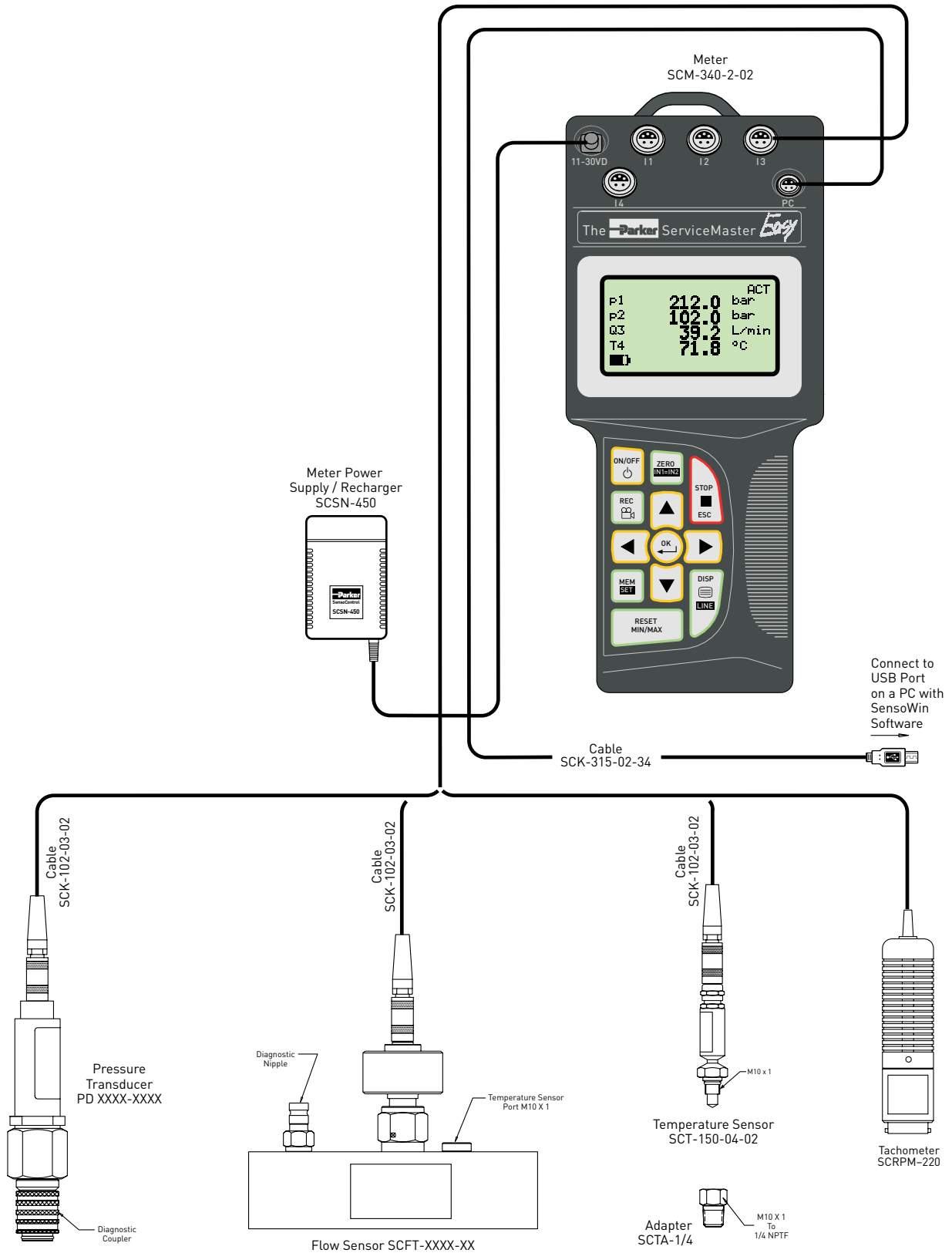

F Diagnostic



Kit Contents:	
Case	SC-690
The Parker Service Master Easy Meter	SCM-340-2-02
2 Transducers (see ordering Information below)	(See Below)
2 Transducer Cables (3m)	SCK-102-03-02
Power Supply	SCSN-450
SensoWin Software 6.0	SC-CD 4082
USB Computer Cable	SCK-315-02-34
Operating Manual (incl. with the Parker Service Master Easy Meter)	

Code for Ordering Service Master Easy Kits:

PDSME XX- X - XX - XX

Transducer Pressure Range
(Choose one or two)

Coupling Style

Meter

Code	Description
2	PD Style
4	PDP Style
6	EMA 3 Style (Female)

Code	Pressure (psi)	Color
01	-14.5 - +220	Blue
06	0 - 870	Green
15	0 - 2175	Yellow
40	0 - 5800	Orange
60	0 - 8700	Red

Code	Description
34	The Parker Service Master Easy 340 Meter

Additional Transducers - Code for Ordering Separately:

PD XXXXX - XXXX

Pressure Range

Coupling Style

Code	Description
TA	PD Style
PTA	PDP Style
TEMA3	EMA 3 Style (Female)

Code	Pressure (psi)	Color
0100	-14.5 - +220	Blue
0600	0 - 870	Green
1500	0 - 2175	Yellow
4000	0 - 5800	Orange
6000	0 - 8700	Red

Flow Sensors - Code for Ordering Separately:

SCFT- XXXX - XXX

Coupling Style

Flow Range

Code	Flow Rate (gpm)
0004	0.2 - 4 (1 - 15 l/min)
0116	1 - 16 (4 - 60 l/min)
0380	3 - 80 (10 - 300 l/min)
5160	5 - 160 (20 - 600 l/min)

Code	Description
PD	PD Style
PDP	PDP Style
EMA	EMA 3 Style (Female)

F Diagnostic



The Service Master Plus combines innovative technology with increased overall capabilities to bring you a premier diagnostic instrument. This tool is more than just a meter; it incorporates data measurement, display, and on-screen analysis to provide increased functionality that extends far beyond standard meters currently on the market.

Capabilities:

- Hand held diagnostic meter
- Measure and Display
 - Pressure
 - Flow
 - Rotational Speed
 - Temperature
 - Auxiliary inputs

Features:

- 26 sensor inputs
- Rugged design
- Auto sensor recognition
- CAN open sensors
- Full color data display options
- Fast scan rate
- Store data to device, micro SD or USB
- SensoWin software utility
- Scan rate of 1ms

Service Master Plus K-SCM-500-01-01-ENG includes:

The Parker Service Master Plus Instrument
Quick Start Manual
Power Supply
USB Connection Cable
SensoWin Software
Category 5 LAN Cable

Service Master Plus K-SCM-500-01-01-ENG Technical Data

Functions	CANbus Inputs	Ambient Operating Conditions
Measurement Accuracy: ±0.25 % FS	2 CANbus networks with 8 inputs each (16 total)	Ambient temperature: 32 to 112 F°
Temp Error: 0.02% FS per °C		Storage temperature: -10 to 140 F°
Display	Scanning Rate: 1 ms	Relative humidity: < 80 %
Visible Area: 115 x 86 mm	Input Impedance: 1 kΩ	Environmental test: IEC60068-2-32 (1 m, free fall)
Resolution 640 x 480 pixels	M12x1, 5 pin push-in connector	
Interfaces	Analog Inputs	Type of Protection
USB device type B (mass storage)	6 Senso Control sensor inputs	IP64 (to EN60529) (Un-connected)
USB host type A (PC Connection)	Parker Automatic Sensor Recognition	IP54 in connected state
10/100 base T Ethernet RJ45	Scanning Rate: 1 ms	Power Supply
Functions	Input Impedance: 1 kΩ	Internal Lithium Ion pack, +7.4 VDC/4500 mAh
Measuring mode: Start/stop, points, trigger	5 pin push-pull connection	External 110/240 VAC - 24 VDC/2500 mA
Measurement: ACT, MIN and MAX	Digital Input /Output	Charge Time: 3h
Measurement display: Numerical, bar graph, pointer, curve graph	Active High 7 to 24 VDC	Run time with fully charged battery: 8h
	Active Low <1 VDC	Housing/protective sleeve
Trigger: Slope, manual, level, window, time, logic, Pre-Trigger	Input Impedance: 1 kΩ	Housing material: ABS/PC (thermoplastic)
	Output Current - 20 mA	Housing protective sleeve material: TPE (thermoplastic elastomer)
Remote operation via the Ethernet	Analog Inputs for auxiliary sensors	Dimensions (w x h x d): 257 mm x 75 mm x 181 mm
Acoustic notification at any incident	2 analog inputs for measuring current and voltage	
Measure value storage	Scanning Rate: 1ms	Weight: 3.4 lbs
6,000,000 points per measurement	Voltage Measuring Range: -10 to +10VDC	
1,000,000,000 points total storage	Current Measuring Range: 0/4 to 20 mA	
On board storage 64 MB	Configurable as FAST-mode analog inputs, 0.1ms scanning rate	
External: Micro SD memory card slot		
External: USB mass storage device		

F Diagnostic

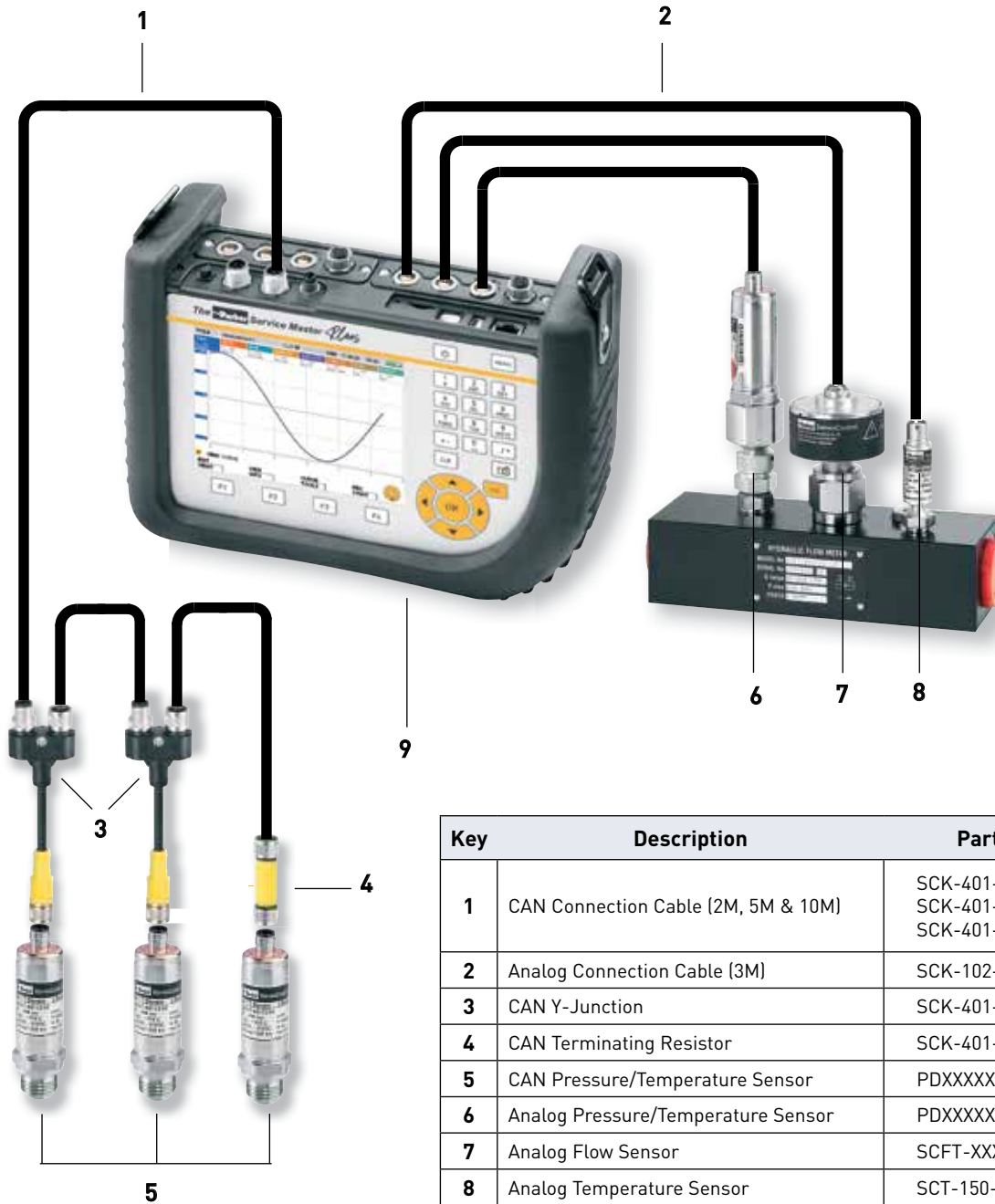

Key	Description	Part Number
1	CAN Connection Cable (2M, 5M & 10M)	SCK-401-02-4F-4M SCK-401-05-4F-4M SCK-401-10-4F-4M
2	Analog Connection Cable (3M)	SCK-102-03-02
3	CAN Y-Junction	SCK-401-0.3-Y
4	CAN Terminating Resistor	SCK-401-R
5	CAN Pressure/Temperature Sensor	PDXXXX-XXXX-CAN
6	Analog Pressure/Temperature Sensor	PDXXXX-XXXX
7	Analog Flow Sensor	SCFT-XXXX-XXX
8	Analog Temperature Sensor	SCT-150-04-02
9	Service Master Plus Instrument	K-SCM-500-01-01-ENG
-	CAN Flow Sensor	SCFT-XXXX-XXX-CAN

F Diagnostic



Kit Contents:	
Case	SCC-500-ENG
The Parker Service Master Plus Instrument	K-SCM-500-01-01-ENG
2 Transducers	(CAN or Analog See Below)
2 Transducer Cables (5m CAN or Analog)	SCK-XXX-XX-X
Power Supply	SCSN-460
USB Connection Cable	SCK-318-02-35
SensoWin Software	
Quick Start Manual	
Category 5 LAN Cable	

Code for Ordering Service Master Plus Kits:

PDSMP 50 - X - XX - XX - XXX

Code	Description
CAN	CAN bus Technology
Blank	Analog

Transducer Pressure Range (choose 2)

Code	Pressure (psi)	Color
01	-14.5 - +220	Blue
06	0 - 870	Green
15	0 - 2175	Yellow
40	0 - 5800	Orange
60	0 - 8700	Red

Coupler Style

Code	Description
2	PD Style
6	EMA 3 Style (Female)

Meter

Code	Description
50	The Parker Service Master Plus

Additional Transducers -
Code for Ordering Separately:

PD XXXXX - XXXX - XXX

Code	Description
CAN	CAN bus Technology
Blank	Analog

Pressure Range

Code	Pressure (psi)	Color
0100	-14.5 - +220	Blue
0600	0 - 870	Green
1500	0 - 2175	Yellow
4000	0 - 5800	Orange
6000	0 - 8700	Red

Coupler Style

Code	Description
TA	PD Style
PTA	PDP Style
TEMA3	EMA 3 Style (Female)

Flow Sensors -

Code for Ordering Separately:

SCFT- XXXX - XXX - XXX

Code	Description
CAN	CAN bus Technology
Blank	Analog

Coupler Style

Code	Description
PD	PD Style
EMA	EMA 3 Style

Flow Range

Code	Flow Rate (gpm)
0004	0.25 - 4 (1 - 15 l/min)
0116	1 - 16 (4 - 60 l/min)
0380	3 - 80 (10 - 300 l/min)
5160	5 - 160 (20 - 600 l/min)



Diagnostic Meters and Accessories

Description	The Parker Serviceman Plus	The Parker Service Master Easy	The Parker Service Master Plus	Part Number
The Parker Serviceman Plus Hand-held meter, 2-3 inputs (Includes SCSN-440 Power Supply)	■			SCM-155-2-05 (CAN) SCM-155-0-02 (Analog)
The Parker Service Master Easy Hand-held meter, 4 inputs, up to 1,000,000 data points (Includes SCSN-450 Power Supply)		■		SCM-340-2-02
The Parker Service Master Plus Hand-held meter, 26 inputs, up to 1,000,000,000 data points (Includes SCSN-460 Power Supply)			■	K-SCM-500-01-01-ENG
Storage Case - Small	■			SCC-210
Storage Case - Medium	■	■		SC-690
Storage Case - Large Roller	■	■	■	SCC-500-ENG
Storage Insert - Holds Extra Sensors Used with SCC-500-ENG Large Roller Case	■	■	■	SCC-500-INLET-ENG
Power Supply 120 Volt AC	■			SCSN-440
Power Supply 120 Volt AC		■		SCSN-450
Power Supply 120 Volt AC			■	SCSN-460
Connection Cable - Analog Used between meter and sensors (3M length)	■	■	■	SCK-102-03-02
Extension Cable - Analog Used in series with connection cables (5M length)	■	■	■	SCK-102-05-12
Connection Cable - CAN Used between meter and sensors (2M, 5M, 10M lengths)	■		■	SCK-401-02-4F-4M SCK-401-05-4F-4M SCK-401-10-4F-4M
Pressure Transducers - Analog Five measurement ranges	■	■	■	See page F-17
Pressure Transducers - CAN Five measurement ranges	■		■	See page F-18
Flow Sensors - Analog Four measurement ranges	■	■	■	See page F-19
Flow Sensors - CAN Four measurement ranges	■		■	See page F-20
Temperature Sensor Used with Parker Flow Sensors or SCTA-1/4 Port Adapter (Requires standard connection cable)	■	■	■	SCT-150-04-02
Port Adapter Converts M10X1 to 1/4" male NPT thread	■	■	■	SCTA-1/4
Tachometer To measure rotational speed (0 to 10,000 RPM)	■	■	■	SCRPM-220
Contact Adapter For SCRPM-220 Tachometer	■	■	■	SCRPMA-001
Focus Adapter For SCRPM-220 Tachometer	■	■	■	SCRPMA-002
Diagnostic Test Hose Assembly (19" & 32" lengths) Used with PD style Parker Transducers and diagnostic nipples	■	■	■	PDH-19 PDH-32
Voltage Adapter Used with auxiliary sensors	■	■	■	SCMA-VADC-600
Frequency Adapter	■	■	■	SCMA-FCU-600

F Diagnostic





Diagnostic Meters and Accessories
Software and Data Cables



Description	The Parker Serviceman Plus	The Parker Service Master Easy	The Parker Service Master Plus	Part Number
The Parker Serviceman Plus Hand-held meter, 2-3 inputs (Includes SCSN-440 Power Supply)	■			SCM-155-2-05 (CAN) SCM-155-0-02 (Analog)
The Parker Service Master Easy Hand-held meter, 4 inputs, up to 1,000,000 data points (Includes SCSN-450 Power Supply)		■		SCM-340-2-02
The Parker Service Master Plus Hand-held meter, 26 inputs, up to 1,000,000,000 data points (Includes SCSN-460 Power Supply)			■	K-SCM-500-01-01-ENG
Data Cable To connect the Serviceman Plus meter to a PC	■			SCK-315-02-36
Data Cable Used between the Parker Service Master Easy meter and a PC		■		SCK-315-02-34
Data Cable Used between the Parker Service Master Plus meter and a PC			■	SCK-318-02-35
SensoWin Software For data transfer from any Parker Service Master meter to a PC	■	■	■	Download from web



Pressure Transducer - Analog

- Five measurement ranges: Vacuum to 8,750 PSI
- Color coded for easy identification
- Corrosion resistant stainless steel housing
- Accuracy of 0.50% Max Full Scale
- Available with PD, PDP or EMA style diagnostic couplings

Analog Transducer Part Numbers and Technical Data

					
	PD ** -0100	PD ** -0600	PD ** -1500	PD ** -4000	PD ** -6000
Color Code	Blue	Green	Yellow	Orange	Red
Measuring Range (Pressure)	-14.5 to 220 psi	0 to 870 psi	0 to 2175 psi	0 to 5800 psi	0 to 8700 ⁽¹⁾ psi
Measuring Range (Temp)	-13°F to 221°F	-13°F to 221°F	-13°F to 221°F	-13°F to 221°F	-13°F to 221°F
Max. Overload Pressure	434 psi	1450 psi	3625 psi	14500 psi	14500 psi
Output Signal (Volts)	-0.2 to 2	0 to 3	0 to 3	0 to 3	0 to 3
Response Time	1 ms	1 ms	1 ms	1 ms	1 ms
Excitation Voltage	7-12 VDC	7-12 VDC	7-12 VDC	7-12 VDC	7-12 VDC
Accuracy (max)	0.50% FS	0.50% FS	0.50% FS	0.50% FS	0.50% FS

1. Maximum Rated Pressure for PD Series Couplers is 6000 psi. Maximum Rated Pressure for EMA Series Couplers is 9000 psi.
2. Analog accessories such as pressure sensors, temperature sensors, flow meters, tachometers and cables are all compatible for use with Serviceman and the Parker Service Master meters.

“ ** ” in the Part Number Represents:

- TA = PD Style
- PTA = PDP Style
- TEMA3 = EMA3 Style (Female)

Materials of Construction

Transducer.....Stainless steel
Diaphragm.....Stainless steel
Coupler.....Chromium-6 Free Plated steel
Seal.....Fluorocarbon

Temperature Range

Working.....-4° to 185°
Fluid.....-13° to 221°
Storage.....-40° to 257°

Output

Accuracy (max).....0.50% FS
Load.....2m ohms
Response time.....<1 ms
Output signal to noise.....0.1%FS
Resonant frequency.....100 KHz

Voltage Requirement

7 to 12 VDC excitation voltage
Permissible ripple.....±2% ss
Current requirement.....5 mA

Cable End (Pin Out)		
Pin	Mark	Wire Colors
1	P	Yellow
2	T	White
3	*	Brown
4	GND	Green
5	SR**	Grey

* V_s = 7-12 VDC
** Sensor Recognition



Pressure Transducer - CAN

- Five measurement ranges: Vacuum to 8,750 PSI
- Compatible for use with the Parker Service Master Plus only
- Color coded for easy identification
- Corrosion resistant stainless steel housing
- Accuracy of 0.50% Max Full Scale
- Available with PD, PDP or EMA style diagnostic couplings

CAN Transducer Part Numbers and Technical Data

					
	PD ** -0100-CAN	PD ** -0600-CAN	PD ** -1500-CAN	PD ** -4000-CAN	PD ** -6000-CAN
Color Code	Blue	Green	Yellow	Orange	Red
Measuring Range (Pressure)	-14.5 to 220 psi	0 to 870 psi	0 to 2175 psi	0 to 5800 psi	0 to 8700 ⁽¹⁾ psi
Measuring Range (Temp)	-13°F to 221°F	-13°F to 221°F	-13°F to 221°F	-13°F to 221°F	-13°F to 221°F
Max. Overload Pressure	434 psi	1740 psi	4350 psi	11600 psi	17400 psi
Response Time	1 ms	1 ms	1 ms	1 ms	1 ms
Excitation Voltage	8-40 VDC	8-40 VDC	8-40 VDC	8-40 VDC	8-40 VDC
Accuracy (max)	0.50% FS	0.50% FS	0.50% FS	0.50% FS	0.50% FS

1. Maximum Rated Pressure for PD Series Couplers is 6000 psi. Maximum Rated Pressure for EMA Series Couplers is 9000 psi.
2. CAN accessories such as pressure transducers, flow sensors, and cables are compatible for use with the Parker Service Master Plus only.

“ ** ” in the Part Number Represents:

- TA = PD Style
- PTA = PDP Style
- TEMA3 = EMA3 Style (Female)

- Excitation Voltage**.....8-40 VDC
- Electrical Connection**.....5 pin, M 12 x 1 connection
- Port Connection**.....1/2 " BSPF
- Housing**.....Stainless Steel 1.4301
- Seal Material**.....FKM
- Ambient Temperature Range**.....-13 to 185°F
- Max. Fluid Temperature**.....221°F
- Shock Resistance**.....IEC 68-2-29
- Vibration Resistance**.....IEC 68-2-6

Cable End (Pin Out)	
Pin	Item
1	Shield
2	V _s = 8...40VDC
3	GND
4	CAN High
5	CAN Low



F Diagnostic



Parker Flow Sensors provide the ability to measure pressure, temperature and flow from a single test point in a hydraulic system. Constructed of light-weight aluminum, they are designed to be used with a wide variety of hydraulic fluids. This design also minimizes the effect of viscosity changes.

Flow sensors are provided with a choice of PD, PDP or EMA style diagnostic ports and are designed to be used with Serviceman Plus (Analog), Parker Service Master Plus and Parker Service Master Easy.

- Four measurement ranges: 0.2 to 160 gpm
- Accuracy of 1% FS or IR
- Provides access ports for temperature and pressure measurement
- Supplied with diagnostic coupling and temperature measurement port

Analog Flow Sensor Part Numbers

Measuring Range	Flow Sensor with PD Nipple	Flow Sensor with PDP Nipple	Flow Sensor with EMA Nipple	Inlet/Outlet Port Configuration	Length (in.)	Height (in.)	Width (in.)
0.2 – 4 gpm (1 – 15 l/min)	SCFT-0004-PD	SCFT-0004-PDP	SCFT-0004-EMA	3/4-16 ORB	5.35	4.61	1.46
1 – 16 gpm (4 – 60 l/min)	SCFT-0116-PD	SCFT-0116-PDP	SCFT-0116-EMA	1 1/16-12 ORB	7.48	5.12	2.44
3 – 80 gpm (10 – 300 l/min)	SCFT-0380-PD	SCFT-0380-PDP	SCFT-0380-EMA	1 5/16-12 ORB	7.48	5.28	2.44
5 – 160 gpm (20 – 600 l/min)	SCFT-5160-PD	SCFT-5160-PDP	SCFT-5160-EMA	1 5/8-12 ORB	8.35	5.91	2.44

Analog Flow Sensors Technical Data

Pressure Rating	6000 PSI
Fluid Temperature Range	-4°F to +194°F
Ambient Temperature Range	-4°F to +122°F
Media/Compatibility	Petroleum Based Fluids (Contact factory for use with water based hydraulic fluids)
Flow Measurement Accuracy	±1.0% Actual Reading
Voltage Input	+7 to 12 VDC (Supplied by SensoControl meter)
Current Requirement	6mA
Response Time	50 ms
Viscosity Range	10 to 100 cSt

Material Specifications

Housing	Anodized Aluminum
Turbine	Stainless Steel
Bearings	Stainless Steel
Seal Material	Nitrile
Electrical Connection	5 Pin Push-Pull Style



Parker Flow Sensors provide the ability to measure pressure, temperature and flow from a single test point in a hydraulic system. Constructed of light-weight aluminum, they are designed to be used with a wide variety of hydraulic fluids. This design also minimizes the effect of viscosity changes.

CAN flow sensors are provided with a choice of PD, PDP or EMA style diagnostic ports and are designed to be used with the Parker Service Master Plus and Serviceman Plus (CAN).

- Four measurement ranges: 0.2 to 160 gpm
- Accuracy of 1% FS or IR
- Provides access ports for temperature and pressure measurement
- Supplied with diagnostic coupling and temperature measurement port

CAN Flow Sensor Part Numbers							
Measuring Range	Flow Sensor with PD Nipple	Flow Sensor with PDP Nipple	Flow Sensor with EMA Nipple	Inlet/Outlet Port Configuration	Length (in.)	Height (in.)	Width (in.)
0.2 – 4 gpm (1 – 15 l/min)	SCFT-0004-PD-CAN	SCFT-0004-PDP-CAN	SCFT-0004-EMA-CAN	3/4-16 ORB	5.35	4.61	1.46
1 – 16 gpm (4 – 60 l/min)	SCFT-0116-PD-CAN	SCFT-0116-PDP-CAN	SCFT-0116-EMA-CAN	1 1/16-12 ORB	7.48	5.12	2.44
3 – 80 gpm (10 – 300 l/min)	SCFT-0380-PD-CAN	SCFT-0380-PDP-CAN	SCFT-0380-EMA-CAN	1 5/16-12 ORB	7.48	5.28	2.44
5 – 160 gpm (20 – 600 l/min)	SCFT-5160-PD-CAN	SCFT-5160-PDP-CAN	SCFT-5160-EMA-CAN	1 5/8-12 ORB	8.35	5.91	2.44

CAN Flow Sensors Technical Data	
Operating Pressure	6000 psi
Overload Pressure	1.2 X Operating Pressure
Max Fluid Temperature	194°F
Ambient Temperature Range	14°F to +122°F
Max Flow	1.1 X Flow Range
Pressure Drop @ FS 21 cSt	21 psi (SCFT-0004) 21 psi (SCFT-0116) 58 psi (SCFT-0380) 72 psi (SCFT-5160)
Flow Measurement Accuracy @21 cSt	1 % FS (SCFT-0004) 1 % IR (SCFT-0116) 1 % IR (SCFT-0380) 1 % IR (SCFT-5160)
FS = Full Scale IR = Indicated Reading	
Voltage Input	8 to 40 VDC
Response Time	50 ms
Filtration	25 um
Viscosity Range	10 to 100 cSt

Material Specifications	
Housing	Aluminum
Wetted Parts	Stainless Steel
Seal Material	FKM

All Parker SensoControl hand-held diagnostic meters are equipped with the same 5-pin push-pull style connector ports. This allows analog accessories such as pressure sensors, temperature sensors, flow meters, tachometers and cables to be compatible with the Serviceman and the Parker Service Master meters.



Temperature Sensor for Serviceman and the Parker Service Master Easy. Can be used with Parker flow sensors or with an SCTA-1/4 port adapter.

Part Number	SCT-150-04-02
Accuracy	+1.5% Full scale
Temperature range	-58°F to 257°F [-50°C to 125°C]



SCRPM Tachometer for Serviceman and the Parker Service Master Easy Meters. Displays a precision measurement of rotational speed. 5-pin push-pull style connector.

Part Number	SCRPM-220
Measuring Range	20 – 10,000 RPM
Measuring Distance	0.1 – 19.5 in
Accuracy	0.5% FS
Excitation Voltage	7 – 9 VDC
Output Signal	0 – 3 VDC
Resolution	5 RPM

Tachometer Adapters

Contact Adapter for belt drive/wheel.	
Part Number	SCRPMA-001
Focus Adapter for confined areas.	
Part Number	SCRPMA-002



Voltage Adapter for use with Auxiliary Sensors to the Parker Service Master Easy.

Part Number	SCMA-VADC-600
Input	0 - 4 A, 0 - 48 VDC
Accuracy	0.25% FS



5 pin to 5 pin Cables Flow sensor, transducer and temperature probe cables for both Serviceman and the Parker Service Master Easy.

Part Number	SCK-102-03-02
Length	10 ft (3 m)
Part Number	SCK-102-05-12
Extension Cable	16.4 ft (5 m)

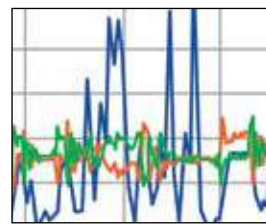

SensoWIN™ Software for data transfer from all Parker Service Master meters to a PC (Windows 98 and newer). SensoWin Software is included with Service Master meters. It is not sold separately, but is available for download from Parker.com



Frequency Converter Converts the signal of a connected sensor into an analog and a CAN frequency. Measurement parameters of the converter can be set via PC with the configurations software

Part Number	SCMA-FCU-600
--------------------	--------------



Ordering Information

Coupler / Nipple Material

- Prefix "B" for Brass Body with Fluorocarbon seal
- Prefix "SS" for Stainless Steel Body with Fluorocarbon seal
- Standard body material is Steel with Nitrile seal
- Suffix "-6" to include Dust Cap with Nipple

Optional Seals Suffix*

No suffix is required when ordering products with the standard Nitrile seals. When specifying an optional seal, refer to the following chart to determine the appropriate suffix.

Coupling Series	Ethylene Propylene	Fluorocarbon	Neoprene
PD Series	W	Y	Z

*To select proper seal materials, see Fluid Compatibility Chart in Appendix section, or contact your Parker Quick Coupling Distributor.

PD Series couplings provide easy connection for mechanical gauges or specialized diagnostic equipment like SensoControl®.

Typically, PD or BPD nipples are permanently mounted in the system at threaded test ports, in rigid tubing or in hose assemblies. PD couplers are attached to test instruments.

Couplers align to the mating nipples without threading. This allows gauges, transducers and other test equipment to be snapped into place without difficulty.

Note: Protective dust caps play a crucial role in the life of a quick coupling and no purchase is complete without the selection of an appropriate dust cap.

Features

- Flush-face poppet valves minimize air inclusion and spillage, provide easy-to-clean surfaces, and help to prevent contamination.
- Grip-tight knurled sleeves help to make connecting and disconnecting easy, even while wearing gloves.
- Nipples are machined from high tensile steel for strength to withstand 6000 PSI continuous operating pressure. BPD nipples offer features similar to the standard steel PD nipples with the added feature of a brass body.
- PD nipples are designed to meet or exceed SAE J1502 and ISO 15171-1 design and performance specifications.
- End connections include pipe, O-ring, metric thread, bulkhead, 37° Flare, ORFS and bite-type.

PD Series Dust Cap

	Body Size	Dust Cap Part No.
	1/8	PD6-285

Specifications - Body Size 1/8"

Description	PD Coupler	PD Nipple	BPD Nipple	Assembly
Part Number	PD242	PD361	BDP343Y	—
Body Material (Steel)	Carbon Steel	High Tensile Steel	Brass	—
Rated Pressure (PSI)	6000	6000	300	6000
Temperature Range (STD Seals) Nitrile	-40°F to +250°F		-15°F to +400°F Fluorocarbon	-40°F to +250°F
Rated Flow (GPM)	—	—	—	0.8
Max. Recommended Flow (GPM)	—	—	—	4.0
Burst Pressure (PSI/Min)	23,000	40,000	—	17,000
Vacuum Data (Inches Hg)	27.5	27.5	27.5	27.5
Pressure Drop at Rated Flow (PSI) with 200 SUS Fluid	—	—	—	56
Spillage at 15 PSI (ml)-Assembly	0.1 per disconnect			
Air Inclusion (ml)-Assembly	0.02 per connect			
Connect Force-Assembly	41 Lbs. (100 PSI)			
Disconnect Force-Assembly	20 Lbs. (100 PSI)			

Couplers- Female Thread



Body Size	Part Number	Thread Size	Overall Length	Wrench Flats	Largest Diameter	Weight
1/8	PD222	1/8-27 NPTF	1.67	0.81	0.96	0.20
1/8	PD240	7/16-20 UNF	2.12	0.81	0.96	0.26
1/8	PD242	1/4-18 NPTF	2.12	0.81	0.96	0.25
1/8	SSPD242Y**	1/4-18 NPTF	2.12	0.81	0.96	0.25
1/8	PD260	9/16-18 UNF	2.12	0.81	0.96	0.24

Couplers- Male Pipe Thread



Body Size	Part Number	Thread Size	Overall Length	Wrench Flats	Largest Diameter	Weight
1/8	PD243	1/4-18 NPTF	2.26	0.81	0.96	0.23

Nipples- Female Pipe Thread



Body Size	Part Number	Thread Size	Overall Length	Exposed Length	Wrench Flats	Largest Diameter	Weight
1/8	PD322	1/8-27 NPTF	1.48	0.78	0.56	0.65	0.06
1/8	PD342	1/4-18 NPTF	1.63	0.93	0.75	0.87	0.12

Nipples- Male Pipe Thread



Body Size	Part Number	Thread Size	Overall Length	Exposed Length	Wrench Flats	Largest Diameter	Weight
1/8	PD323	1/8-27 NPTF	1.55	0.85	0.69	0.79	0.17
1/8	BPD323Y*	1/8-27 NPTF	1.44	0.74	0.63	0.72	0.17
1/8	BPD343Y*	1/4-18 NPTF	1.48	0.78	0.69	0.79	0.06
1/8	PD343	1/4-18 NPTF	1.48	0.78	0.69	0.79	0.06
1/8	SSPD343Y**	1/4-18 NPTF	1.48	0.78	0.69	0.79	0.06
1/8	PD363	3/8-18 NPTF	1.50	1.13	0.81	0.96	0.09

* BPD designates brass body, Fluorocarbon seal standard
** SSPD designates 316SS body, Fluorocarbon seal standard



Note: Add -6 to Nipple part number to include dust cap, for example PD343-6

Nipples- Male Metric Thread



Body Size	Part Number	Thread Size Metric	Overall Length	Exposed Length	Wrench Flats	Largest Diameter	Weight
1/8	PD357	M10 x 1.0	1.80	1.10	0.69	0.79	0.17
1/8	PD3107	M16 x 1.5	1.54	0.84	0.88	1.01	0.08
1/8	PD3127	M18 x 1.5	1.60	0.90	0.94	1.08	0.09
1/8	PD3147	M20 x 1.5	1.50	0.80	0.75	0.87	0.07

Nipples- Male Straight Thread



Body Size	Part Number	Thread Size ORB	Overall Length	Exposed Length	Wrench Flats	Largest Diameter	Weight
1/8	PD331	3/8-24 UNF	1.80	1.10	0.69	0.79	0.17
1/8	PD341	7/16-20 UNF	1.60	0.90	0.69	0.79	0.08
1/8	PD351	1/2-20 UNF	1.32	0.62	0.63	0.72	0.05
1/8	PD361	9/16-18 UNF	1.32	0.62	0.69	0.79	0.06

Nipples- Bulkhead Triple-Lok



Body Size	Part Number	Thread Size	Tube Size	Overall Length	Exposed Length	Wrench Flats	Largest Diameter	Weight
1/8	PD345	7/16-20 UNF	1/4	2.92	2.22	0.81	0.94	0.19
1/8	PD355	1/2-20 UNF	5/16	2.92	2.22	0.81	0.94	0.19
1/8	PD365	9/16-18 UNF	3/8	3.00	2.30	0.81	0.94	0.20

Nipples- Bulkhead Seal-Lok



Body Size	Part Number	Thread Size	Tube Size	Overall Length	Exposed Length	Wrench Flats	Largest Diameter	Weight
1/8	PD346	9/16-18 UNF	1/4	2.98	2.27	0.81	0.94	-
1/8	PD366	11/16-16 UNF	3/8	3.08	2.37	1.00	1.16	-
1/8	PD386	13/16-16 UNF	1/2	3.18	2.47	1.12	1.30	-

* Note: Add -6 to part number to include dust cap, for example PD343-6

* BPD designates brass body, Fluorocarbon seal standard

** SSPD designates 316SS body, Fluorocarbon seal standard

Tube End Nipples*- Triple Lok



Body Size	Part Number Steel	Tube Size	Overall Length	Exposed Length	Weight
1/8	PD34BTX	1/4	1.64	0.94	0.10
1/8	PD36BTX	3/8	1.66	0.96	0.09



1/8	PD38BTX	1/2	1.17	0.47	0.12
1/8	PD312BTX	3/4	1.39	0.69	0.27

* Tube end nipples are designed to meet the performance standards of the tube or hose fitting connection, which may or may not meet SAE J1502 Standards

Tube End Nipples*- Seal Lok



Body Size	Part Number Steel	Tube Size	Overall Length	Exposed Length	Weight
1/8	PD34BTL	1/4	2.18	1.48	0.12
1/8	PD36BTL	3/8	2.30	1.60	0.14



1/8	PD38BTL	1/2	1.57	0.83	0.13
1/8	PD310BTL	5/8	1.16	0.46	0.19

* Tube end nipples are designed to meet the performance standards of the tube or hose fitting connection, which may or may not meet SAE J1502 Standards



Note: Add -6 to Nipple part number to include dust cap, for example PD343-6

F Diagnostic



PDP Series couplings provide easy connection for mechanical gauges or specialized diagnostic equipment like SensoControl. Typically, PDP nipples are permanently mounted in the system at threaded test ports, in rigid tubing or in hose assemblies. PDP couplers are attached to test instruments.

Locking balls align the couplers to the mating nipples without threading, so gauges, transducers and other test equipment can be snapped into place without difficulty.

Parker's PDP Series couplings offer the advantages of PD couplings, but are designed to connect easily and quickly under full system pressure up to 6000 PSI (operating).

PDP couplers and nipples push to connect with a constant force of only six pounds. Then the coupler base is turned to open the valve and complete the connection. In the connected position, the coupler base blocks the retracting sleeve to prevent accidental disconnects.

Features

- Made to connect under pressure up to 6000 psi
- Grip-tight knurled sleeves help to make connecting and disconnecting easy, even while wearing gloves.
- Nipples are machined from high tensile steel for strength to withstand 6000 PSI continuous operating pressure.
- End connections include pipe, O-ring, 37° Flare and ORFS
- Durable Ball Valve Nipple.
- Coupler is unvalved to allow gauges and transducers to return to zero when disconnected.

Specifications - Body Size 1/8"			
Description	PDP Coupler	PDP Nipple	Assembly
Body Material (Steel)	Carbon Steel	High Tensile Steel	—
Rated Pressure (PSI)	-	6000	6000
Temperature Range (STD Seals) Nitrile	-40°F to +250°F		
Connect Force-Assembly	6 Lbs. (0-6000 PSI)		
Disconnect Force-Assembly	7 Lbs. (0-6000 PSI)		

PD Series Dust Cap		
	Body Size	Dust Cap Part No.
	1/8	PD6-285



Note: Add -6 to Nipple part number to include dust cap, for example PDP343-6

Ordering Information
Coupling / Nipple Material: Standard body material is Steel Standard seal material is Nitrile

Optional Seals Suffix*			
Coupling Series	Ethylene Propylene	Fluorocarbon	Neoprene
PDP Series	W	Y	Z

*To select proper seal materials, see Fluid Compatibility Chart in Appendix section, or contact your Parker Quick Coupling Distributor.

Coupler - Female Thread



Body Size	Part Number Steel	Thread Size	Overall Length	Largest Diameter	Wrench Flats	Weight
1/8	PDP242	1/4-18 NPTF	2.15	0.96	0.81	-

Nipples - Male Pipe Thread



Body Size	Part Number	Thread Size	Overall Length	Exposed Length	Wrench Flats	Largest Diameter	Weight
1/8	PDP323	1/8-27 NPTF	2.02	1.46	0.69	0.79	0.26
1/8	PDP343	1/4-18 NPTF	1.48	0.93	0.69	0.79	0.12

Nipples - Male Straight Thread



Body Size	Part Number	Thread Size ORB	Overall Length	Exposed Length	Wrench Flats	Largest Diameter	Weight
1/8	PDP341	7/16-20 UNF	2.06	1.50	0.69	0.79	0.12
1/8	PDP361	9/16-18 UNF	1.48	0.93	0.69	0.79	0.07

Nipples - Triple-Lok



Body Size	Part Number	Tube Size	Overall Length	Exposed Length	Wrench Flats	Largest Diameter	Weight
1/8	PDP34BTX	1/4	2.11	1.55	0.69	.80	-
1/8	PDP36BTX	3/8	2.13	1.57	0.69	.80	-

Nipples - Seal-Lok



Body Size	Part Number	Tube Size	Overall Length	Exposed Length	Wrench Flats	Largest Diameter	Weight
1/8	PDP34BTL	1/4	2.65	2.09	.69	.80	-
1/8	PDP36BTL	3/8	2.77	2.21	.81	.94	-

F Diagnostic



EMA couplings provide easy diagnostic connections for Parker SensoControl® equipment or mechanical gages. EMA test points are typically permanently plumbed into a fluid system at locations where pressure measurements are required for maintenance or testing. Integral pressure cap protects the test point from damage and prevents contamination of the fluid system. Proven twist-to-connect design allows the test points to be connected even when the system is in operation and the test points are pressurized. EMA's compact design and optional high pressure hose assemblies allow extra flexibility for the location of system test points.

Although designed primarily for diagnostic applications, EMA fittings and hose assemblies are ideal for a wide range of applications that require compact high pressure connections and limited flow rates.

Features

- Knurled sleeve allows simple twist-to-connect operation without the use of tools
- Rugged design allows connect-under-pressure operation up to 5800 psi
- Maximum rated working pressure of 9000 psi exceeds the requirements of most applications
- Integral threaded dust cap protects the test point from damage and contamination
- EMA fittings are machined from solid barstock and protected with Chromium-6 Free plating.
- Stainless steel springs for corrosion resistance
- Elastomeric interface and valve seals provide leak free operation
- Compact design and optional high pressure hose assemblies provide flexibility for tight space requirements

Specifications

Body Size	1/8
Rated Pressure (psi)	9000 PSI
Max Connect-Under-Pressure (psi)	5800
Rated Flow (GPM)	0.8
Body Material	Chromium-6 Free Plated Steel
Standard Seal Material	Nitrile (external) Fluorocarbon (internal)
Temperature Range (std. seals)	-15° to +250° F

Male Pipe Thread



Part Number	Port Thread Size	Wrench Flats	Interface Thread Size	Overall Length	Weight
EMA3/1/8NPT	1/8-27NPT	17	M16X2.0	1.81	0.15
EMA3/1/4NPT	1/4-18NPT	17	M16X2.0	1.98	0.16
EMA3/1/4NPT71 Stainless Steel	1/4-18NPT	17	M16X2.0	1.95	0.16

SAE Straight Thread



Part Number	Port Thread Size	Wrench Flats	Interface Thread Size	Overall Length	Weight
EMA3/7/16-20UNF-2A*	7/16-20UNF-2A	17	M16X2.0	1.88	0.15
EMA3/9/16-18UNF-2A*	9/16-18UNF-2A	19	M16X2.0	1.88	0.17

* O-Ring seal on port

Metric Straight Thread



Part Number	Port Thread Size	Wrench Flats	Interface Thread Size	Overall Length	Weight
EMA3/M8X10R*	M8X1	17	M16X2.0	1.81	0.15
EMA3/10X1ED**	M10X1	17	M16X2.0	1.85	0.15
EMA3/12X1.5ED**	M12X1.5	17	M16X2.0	1.94	0.16
EMA3/14X1.5ED**	M14X1.5	19	M16X2.0	1.94	0.16

* O-Ring seal on port **Molded seal on port

British Parallel Pipe



Part Number	Port Thread Size	Wrench Flats	Interface Thread Size	Overall Length	Weight
EMA3/1/8ED**	1/8 BSPP	19	M16X2.0	1.77	0.15
EMA3/1/4ED**	1/4 BSPP	19	M16X2.0	1.94	0.16
EMA3/3/8ED**	3/8 BSPP	21	M16X2.0	1.94	0.16

**Molded seal on port

EMA Gauge Adapter



Part Number	Port Thread Size	Wrench Flats	Port Thread Size	Overall Length	Weight
MAV1/4NPT-MA3	1/4-18NPT	19	M16X2.0	2.22	0.16
MAV1/4NPT-MA3-KM Includes Dust Cap	1/4-18NPT	19	M16X2.0	2.22	0.23

EMA Gauge Adapter



Part Number	Port Thread Size	Wrench Flats	Port Thread Size	Overall Length	Weight
MAVMD1/4NPT-MA3	1/4-18NPT	19	M16X2.0	2.22	0.18

Union



Part Number	Port Thread Size	Wrench Flats	Port Thread Size	Overall Length	Weight
EMA3VS	M16X2.0	17	M16X2.0	1.65	0.11

Transducer Adapters 1/2 - 14 BSPP Thread*



Part Number	Overall Length	Weight	Largest Diameter	Port Thread Size	Interface Thread Size	Weight
PD288	2.52	1.19	1.38	1/2-14BSPP	-	0.35



PDP288	2.58	1.19	1.38	1/2-14BSPP	-	0.35
--------	------	------	------	------------	---	------



SCA-1/2-EMA-3	2.07	27mm	-	1/2-14BSPP	M16X2.0	0.30
---------------	------	------	---	------------	---------	------

* Note: For old style M22X1.5 thread contact QCD

Flexible Hose



Part Number	Length (in.)	Length (mm)	Thread Size A
SMA3-200	7.90	200	M16x2.0
SMA3-400	15.75	400	M16x2.0
SMA3-800	31.50	800	M16x2.0
SMA3-2000	78.75	2000	M16x2.0
SMA3-4000	157.50	4000	M16x2.0

Note: Other lengths available upon request.
Maximum pressure rating for test hose is 9000 psi.



These diagnostic fluid sampling products are designed to provide an easy access point for obtaining fluid samples. A permanently mounted test point eliminates the need to shut down or break lines when taking samples and reduces the chances of contamination. Fluid analysis is crucial in both engines and hydraulic systems as it can reveal problems with filtration and other internal components. Early detection can prevent costly repairs, unscheduled maintenance and production downtime. These fluid sampling nipples should be installed in either low pressure or return lines. For the most accurate monitoring, fluid samples should be constantly taken from the same location.

Specifications	
Body Size	1/8
Rated Pressure (PSI)	500 PSI
Seal Material	Fluorocarbon
Temperature Range (std. seals (Fluorocarbon))	-40° to +250° F

Couplers- Female Thread



Body Size	Part Number	Female Thread NPTF	Female Thread ORB	Overall Length	Wrench Flats	Largest Diameter	Weight
1/8	PDFS242	1/4-18	-	2.15	0.81	0.96	0.25

Nipples- Male Thread



Body Size	Part Number	Thread Size ORB or NPTF	Thread Size Metric	Overall Length	Exposed Length	Wrench Flats	Largest Diameter	Weight
1/8	BPDFS341	7/16-20 ORB		1.60	0.90	0.69	0.79	0.08
1/8	BPDFS343	1/4-18 NPTF		1.48	0.78	0.69	0.79	0.06
1/8	PDFS-PROBE*		NA	-	-	-	-	-

Fluorocarbon seal is standard.
Dust Cap PD6-285 is recommended.

F Diagnostic